



Motorcycle Art

F3



MV AGUSTA F3 675 - F3 SERIE ORO

Motorcycle Workshop Manual

© 2012

The reproduction, even partial of this document is forbidden without prior written agreement of MV Agusta Motor S.p.A.

Part no. 8A00B7594 - Edition no. 1

Printed - April 2012

Motorcycle workshop manual

MV AGUSTA F3 675 - F3 SERIE ORO

F3

MV **AGUSTA**



Statement

This manual, to be used by the MV Agusta authorised workshops has been realised with the purpose of assisting authorised personnel in maintenance and repairs operations of the motorcycle. The knowledge of technical data herein noted, determines the complete professional training of the technician.

With purpose of making the reading of this manual immediately comprehensible, the paragraphs have been aligned with detailed illustrations that highlight the argument dealt with.

Useful advice

To prevent any problems and to reach an excellent final result, MV Agusta recommends keeping to the following guidelines:

- In the case of an eventual repair, evaluate the client's impressions who states that there is an abnormal functioning of the motorcycle and to formulate the right questions to clarify the symptoms of the problem.
- Clearly diagnose the cause of the abnormality. The basic fundamental theories can be absorbed by reading this manual that must necessarily be integrated to the personal experience and the participation of training courses that are periodically organised by MV Agusta.
- Rationally plan the repair to avoid slack periods, e.g. the collection of spare parts, the preparation of tools and equipment, etc.
- To reach the part to be repaired limiting the work to the essential operations. With regards to this, a valid help would be to consult this manual with regards to the sequences of removal demonstrated in this manual.

Informative note

MV Agusta Motor S.p.A. is committed to a policy of continuous improvement of their products. For this reason, there could be slight differences between that which is written here and the motorcycle on which repairs and/or maintenance are about to be carried out. MV Agusta models are exported to many countries where different norms in relation to the highway code and homologation procedures are valid. Hoping that you will comprehend these problems, MV Agusta Motor S.p.A. reserves the right to make modifications to its products and technical documentation at any moment and without prior announcement.



Respect and defend the environment

Everything that we do has repercussions on the entire planet and its resources.

MV Agusta, wanting to protect the interest of the people, would like to make the client and the technicians of the technical assistance centres aware and to adopt modalities of use of the motorcycle and the disposal of its parts in full respect of the norms in force in terms of environmental pollution, disposal and the recycling of waste.



General Index

GENERAL DESCRIPTION	A Rev. 0
MAINTENANCE	B Rev. 0
BODYWORK	C Rev. 0
AIR INTAKE INJECTION SYSTEM	D Rev. 0
ELECTRICAL SYSTEM	E Rev. 0
SUSPENSION AND WHEELS	F Rev. 0
FRAME	G Rev. 0
BRAKES	H Rev. 0
COOLING SYSTEM	L Rev. 0
SPECIAL TOOLS	M Rev. 0
TORQUE PRESSURES	N Rev. 0
DIAGNOSTICS	O Rev. 0
ANALYTICAL INDEX	P Rev. 0



General description

A

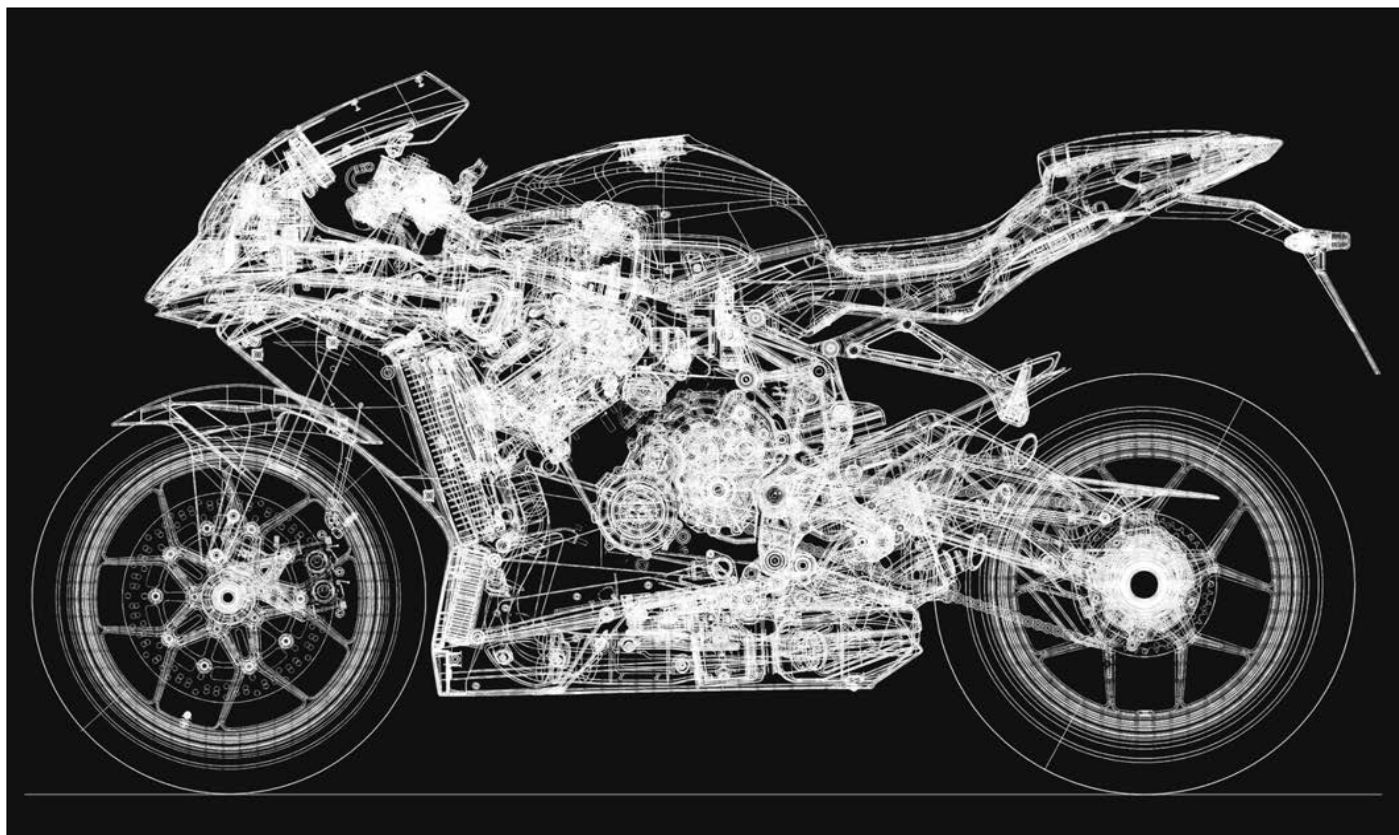

SECTION A
Revision 0



A

SUMMARY

HOW TO CONSULT THIS MANUAL	PAGE 3
THE PURPOSE OF THIS MANUAL	PAGE 3
GLOSSARY AND SYMBOLS	PAGE 4
RIGHT HAND AND LEFT HAND STANDARD	PAGE 5
SAFETY	PAGE 6
OBSERVATIONS	PAGE 8
INDEX	PAGE 8
OPERATIVE TECHNICAL SPECIFICATIONS	PAGE 9



General description

A GLOSSARY AND SYMBOLS



ATTENTION

This signifies that the lack of or the incomplete observance of this advice can be gravely dangerous for your safety and for the safety of other persons.

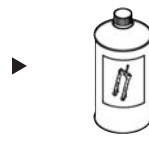

Use the recommended suspension fluid.



WARNING

This signifies that the lack of observance of these instructions can bring the risk of damage to the motorcycle and the equipment.

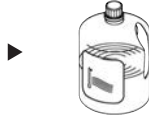

Use the recommended coolant.



Supplies key information for the best fulfilment of the operation.



Use the recommended thread-locking fluid.



Utilise a specific tool or equipment for the correct carrying out of the operation described.



Use the recommended sealant.



Tighten to the specified torque.

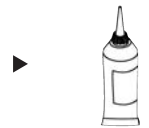

Use the recommended adhesive.



Tolerance or limit of use.



Carry out accurate cleaning.

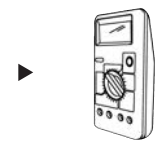

Utilise the tester.

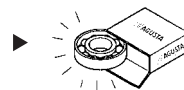

Use new components.



Use the recommended oil.



Substitute the component.



Use the recommended grease.



Do not leave litter about.

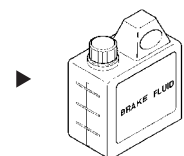

Use the recommended brake fluid.



General description

RIGHT HAND AND LEFT HAND STANDARD

To clarify the right hand and left hand standard that is used in this manual, herewith below is a diagram of the motorcycle and the engine against which are indicated the right and left sides.

A

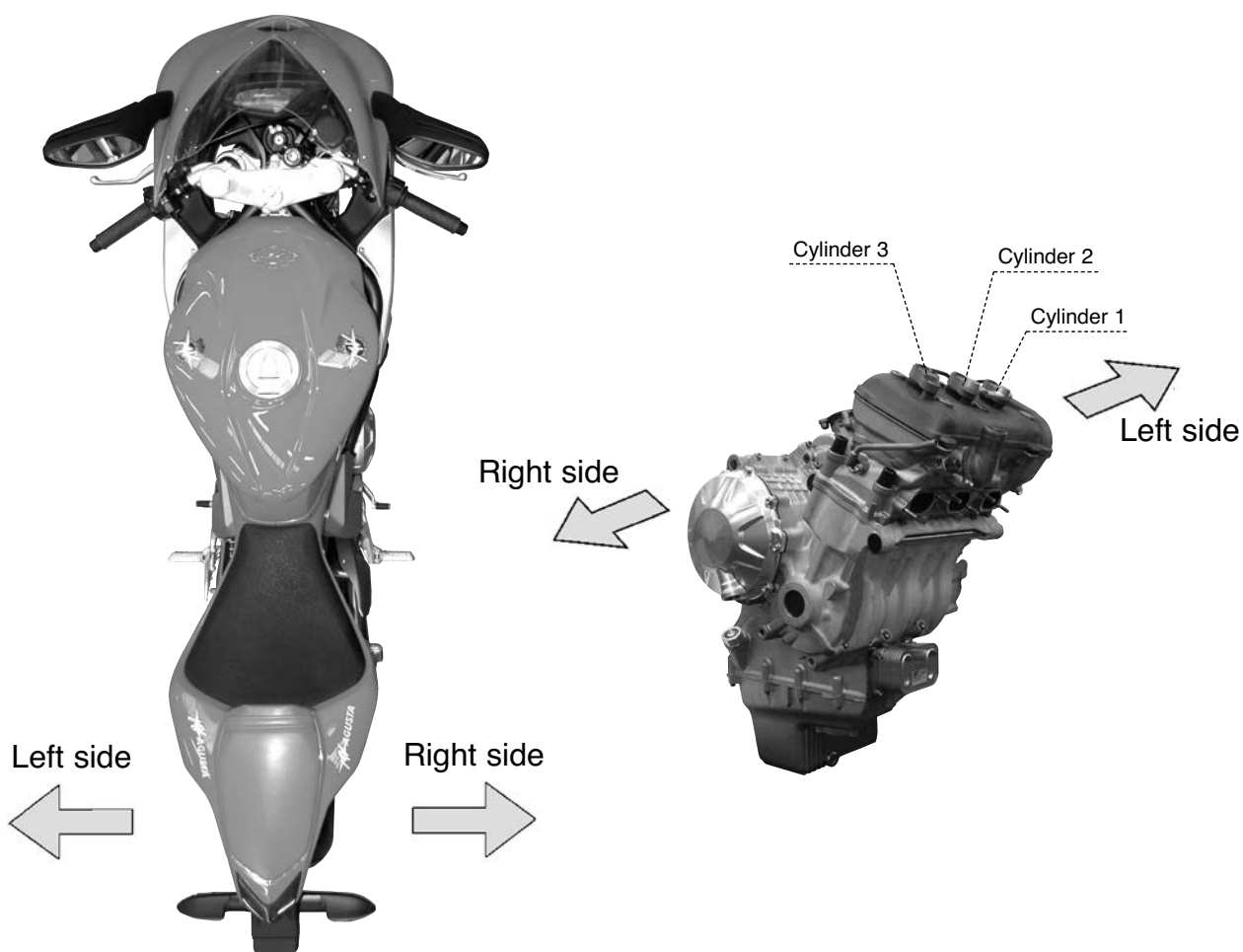



General description

A SAFETY



The information contained in this paragraph is fundamental so that the operations carried out on the motorcycle can be conducted with minimum risk to the mechanic.

Carbon Monoxide

- Exhaust gases contain carbon monoxide (CO) that is poisonous. Carbon monoxide can cause the loss of consciousness and death.
- If it is necessary to switch on the engine, check that the environment is well ventilated. Never switch on the engine in an enclosed environment.
- Switching on the engine can only be carried out in an enclosed environment when there are the appropriate devices for the evacuation of exhaust gases.

Petrol

- Petrol is extremely inflammable and under certain conditions can be explosive.
- Keep sources of heat, sparks and flames away from the work area.
- Always work in a well-ventilated area.
- Never use petrol as a cleaning solvent. Generally, avoid handling it unless it is absolutely necessary.
- Do not use petrol for cleaning components by using compressed air.
- Keep petrol out of reach of children.

Engine oil

- Engine oil can cause skin illnesses if in constant and long contact with the skin.
- If the skin comes into contact with engine oil, wash the parts affected as soon as possible with soap and water.
- If engine oil comes into contact with the eyes, abundantly rinse with water and consult a doctor immediately.
- If engine oil is swallowed, do not provoke vomiting to avoid the aspiration of the product into the lungs. Transport the injured person immediately to hospital.
- Used oil contains dangerous substances and poisonous for the environment. To substitute oil, it is recommended to go to an authorised MV Agusta dealer who is equipped to deal with the collection of used oil in respect of the norms in force.
- Do not dispose of used oil in the environment.
- Keep used oil out of the reach of children.

Engine coolant

- Under certain situations, the ethylene glycol contained in the engine coolant is inflammable and its flame is invisible. Ethylene glycol would cause serious burns if ignited because it is invisible.
- Avoid bringing the engine coolant into contact with hot parts. Such parts could be sufficiently hot to ignite the coolant.
- The engine coolant (ethylene glycol) can cause irritation of the skin and is poisonous if swallowed.
- If the engine coolant comes into contact with the skin, immediately remove any contaminated clothing and wash with soap and water. If it comes into contact with the eyes, abundantly rinse with clean water and immediately consult a doctor. If swallowed, do not provoke vomiting to avoid the aspiration of the product into the lungs. Administer clean water and transport the injured person immediately to hospital and show the product to the doctor.
- If exposed to high concentrations of vapour, transport the injured person to a non-poisonous atmosphere and if necessary call a doctor.
- Do not remove the radiator cap when the engine is still hot. Being under pressure, the engine coolant can be violently ejected and therefore provoke burns.
- The engine coolant contains dangerous and poisonous substances and is therefore dangerous for the environment. To substitute used engine coolant, it is advisable to go to the authorised MV Agusta dealer who is equipped to deal with the collection of used engine coolant in respect of the norms in force.
- Do not dispose of engine coolant in the environment.
- Keep engine coolant out of reach of children.



General description

A

Brake fluid

- Brake fluid is extremely corrosive.
- Avoid any contacts with the eyes, skin and the mucous membrane.
- If brake liquid comes into contact with the skin, remove all contaminated clothing and wash immediately with soap and water.
- If brake fluid comes into contact with the eyes, abundantly rinse with water and call a doctor.
- If swallowed, do not provoke vomiting to avoid aspiration of the product into the lungs. Immediately call a doctor.
- Take the injured person immediately to hospital, if he has breathed brake fluid into the lungs.
- In the case of exposure to high concentrations of vapour, move the injured person to a non-poisonous atmosphere and if necessary call a doctor.
- In the case of accidental contact, rinse abundantly with water and call a doctor.
- Keep brake fluid out of reach of children.

Thread-locking fluid

- As it is not classified as dangerous, the prolonged contact with the skin, particularly with regards to abrasions can provoke sensitiveness and dermatitis. In the case of contact with the skin, rinse abundantly with running water.
- Move the injured person into the open air and call a doctor if the injured person feels ill after having breathed in the product.
- In the case of contact with the eyes, rinse abundantly with water for at least 15 minutes.
- If the thread-locking fluid has been swallowed, drink an abundant quantity of water or milk. Do not provoke vomiting to avoid the aspiration of the product into the lungs. Immediately call a doctor.
- Keep out of reach of children.

Nitrogen - rear shock absorber

- The rear shock absorber contains nitrogen under pressure.
- Before disposing of used shock absorbers, discharge the nitrogen via the depressurising valve.
- Utilise only nitrogen to pressurise the shock absorber. The use of unstable gases can cause explosions that could cause burns.
- Do not place the shock absorber near to flames or sources of heat as this could cause explosions with consequent burns.
- Keep out of reach of children.

Battery

- The battery produces explosive gases. Keep it away from sparks, flames or cigarettes. During recharging, adequately ventilate the environment.
- The battery contains a solution of sulphuric acid (electrolyte).
- Sulphuric acid is corrosive and it destroys many materials and clothing. On contact with small quantities of water it generates a violent reaction that manifests itself by creating large quantity of heat and spurts of hot acid. Sulphuric acid attacks many metals thereby liberating hydrogen: an inflammable gas that forms an explosive mixture when mixed with air.
- Contact with sulphuric acid can cause burns. In the case of contact, remove immediately all contaminated clothing and wash the skin with abundant quantities of water. Take the injured person to hospital if necessary.
- In the case of contact with the eyes, rinse immediately with abundant water. Call a doctor and continue with the treatment until the doctor arrives.
- If the electrolyte is swallowed, rinse the mouth with water without swallowing. Take the injured person immediately to hospital and explain to the doctor there what the injured person has swallowed.
- The battery contains dangerous substances that are poisonous for the environment. It is advisable to substitute it at an MV Agusta dealer that is equipped to dispose of this product in respect of the norms in force.
- Do not dispose of used batteries in the environment.
- Keep out of reach of children.

Hot parts

- The engine and the exhaust system become very hot and maintain this temperature for some time after the engine has been switched off. Wait for these parts to cool down before handling them or working on the motorcycle near to them. Use protective gloves.



General description

A

WARNING



WARNING

The information contained in this paragraph is important so that the operations carried out on the motorcycle can be conducted without damaging the motorcycle.

- Thoroughly clean the motorcycle before disassembling it.
- During disassembly, clean all parts and place them in containers respecting exactly the order of disassembly.
- Always use the special utensils where necessary and each time where prescribed.
- Always use adhesives, sealants and lubricants where prescribed. Respect the instructions about their technical characteristics.
- Always substitute parts such as gaskets, O-rings, security washers with new parts.
- Slackening or tightening nuts or screws, always start with those of a greater dimension or from the centre. Always respect the torque values indicated.
- Utilise only MV Agusta spare parts.

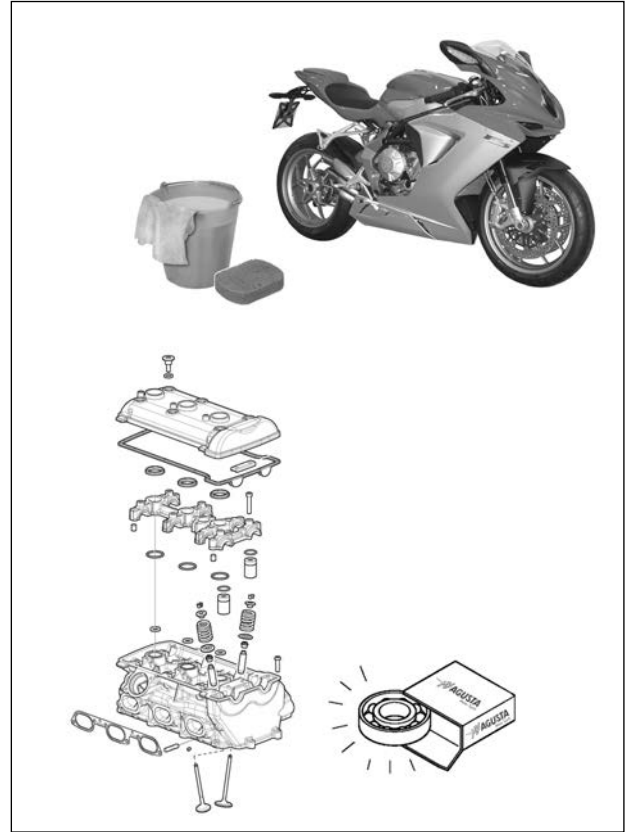

INDEX

GENERAL INDEX

General Index	
GENERAL DESCRIPTION.....	A
MAINTENANCE	B
BODYWORK	C
AIR INTAKE INJECTION SYSTEM	D
ELECTRICAL SYSTEM	E
SUSPENSION AND WHEELS	F
FRAME	G
BRAKES.....	H
COOLING SYSTEM	L
SPECIAL TOOLS	M
TORQUE PRESSURES	N
DIAGNOSTICS	O
ANALYTICAL INDEX	P

SUMMARY OF EACH CHAPTER

General description	
SUMMARY	
HOW TO CONSULT THIS MANUAL	PAGE 3
THE PURPOSE OF THIS MANUAL	PAGE 3
GLOSSARY AND SYMBOLS	PAGE 4
RIGHT HAND AND LEFT HAND STANDARD	PAGE 5
SAFETY	PAGE 6
OBSERVATIONS	PAGE 8
INDEX	PAGE 8
OPERATIVE TECHNICAL SPECIFICATIONS	PAGE 9



General description

OPERATIVE TECHNICAL SPECIFICATIONS

MOTORCYCLE IDENTIFICATION

The registration number of the motorcycle is stamped on the right side of the steering head.

The engine registration number is stamped on the upper engine casing, near the swingarm.

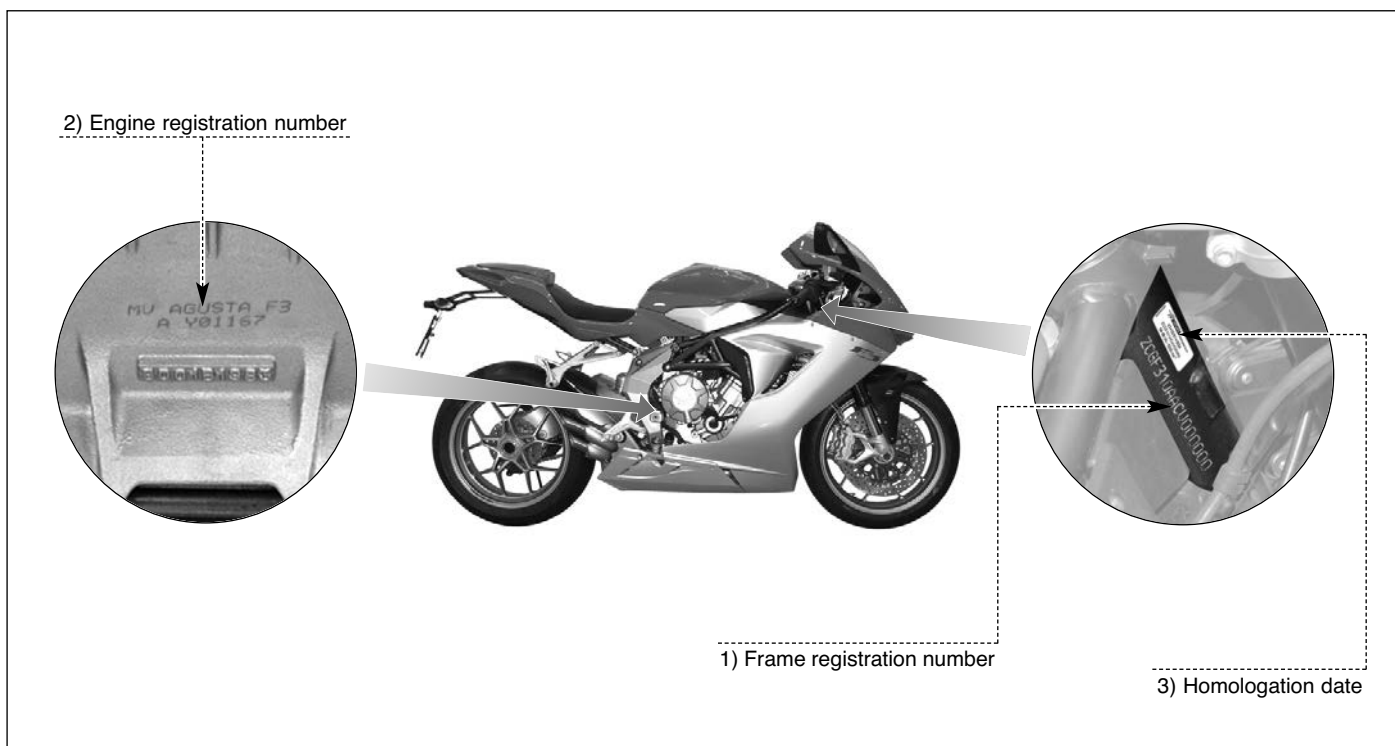

Below is an example of the designation of the frame registration number:

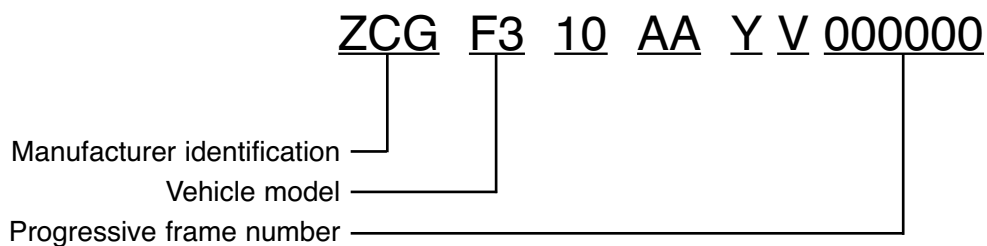



General description

A

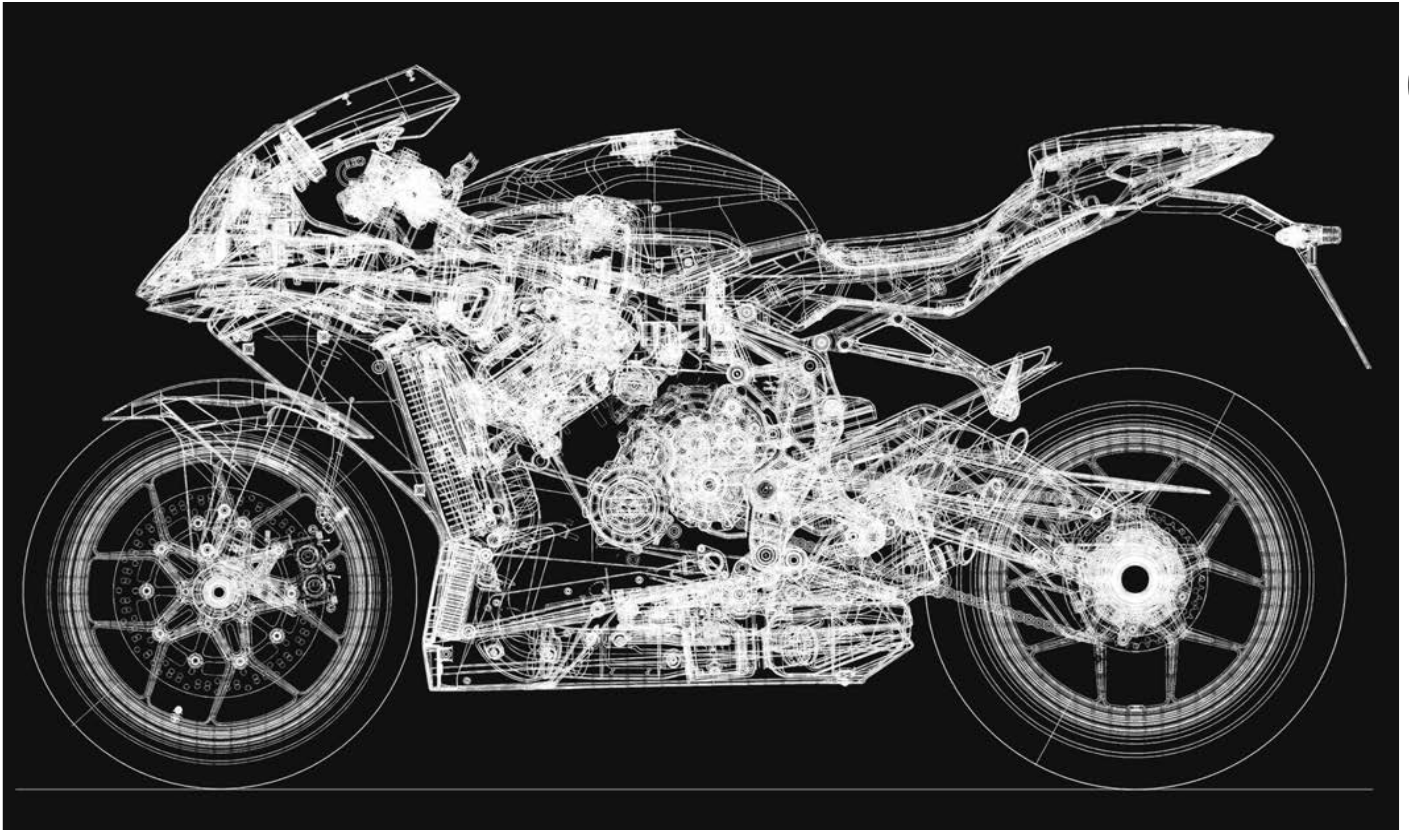

B

SECTION B
Revision 0



SUMMARY

TECHNICAL INFORMATION	PAGE 3
PERIODICAL MAINTENANCE SCHEDULE	PAGE 6
MAINTENANCE AND TUNING OPERATIONS	PAGE 8
ENGINE OIL AND OIL FILTER	PAGE 8
ENGINE COOLANT	PAGE 11
ELECTRIC COOLING FAN	PAGE 14
VALVE MECHANISM ADJUSTMENT	PAGE 15
SPARK PLUGS	PAGE 18
FUEL FILTERS	PAGE 20
FUEL PUMP ASSEMBLY	PAGE 27
TUBES / FUEL FITTINGS	PAGE 29
CHECKING ENGINE DURING IDLE	PAGE 34
BRAKES	PAGE 36
BRAKE / GEARCHANGE COMMANDS CHECK	PAGE 41
BRAKE PADS	PAGE 45
LOCKS	PAGE 46
STEERING	PAGE 49
TRANSMISSION CHAIN	PAGE 49
TYRES	PAGE 52
FRONT WHEEL BEARINGS	PAGE 52
WHEELS	PAGE 53
REAR WHEEL HUB	PAGE 53
SWINGARM BEARINGS	PAGE 53
REAR SHOCK ABSORBER	PAGE 54
SIDE STAND	PAGE 55
FRONT FORKS	PAGE 56
NUTS AND BOLTS	PAGE 57
TUBE FASTENING BANDS	PAGE 57
ELECTRICAL SYSTEM	PAGE 57
BATTERY	PAGE 57
WARNING LIGHTS AND INSTRUMENTATION	PAGE 57
LIGHTS	PAGE 86
FUSES	PAGE 95
FRONT HEADLIGHT	PAGE 98



TECHNICAL INFORMATION

B



TECHNICAL DATA

Description	F3 675	F3 ORO
CHARACTERISTICS		
Wheelbase (mm) (*)		1380
Total length (mm) (*)		2060
Maximum width (mm)		725
Seat height (mm) (*)		805
Ground clearance (mm) (*)		125
Trail (mm) (*)		99
Dry weight (kg)		179
Fuel tank capacity (lt) (**)		16
Fuel reserve (lt) (**)		5
Sump oil quantity (kg)		2,5
ENGINE		
Type	Three-cylinder, four-stroke, 12 valves	
Bore (mm)	79	
Stroke (mm)	45,9	
Displacement (cm ³)	675	
Compression ratio	13 : 1	
Starter system	Electrical	
Cooling	Cooling with separate liquid and oil radiators	
Engine casing and covers	Die-cast	
Cylinder head and cylinders	Chill-cast	
Valves	Titanium	

* : The data declared are not binding. They are susceptible to variations due to riding conditions.

** : The data declared are not binding. They are susceptible to variations due to external temperature, engine temperature and the evaporation point of the petrol used.



Maintenance

TECHNICAL DATA

Description	F3 675	F3 ORO
TIMING		
Type	Double-overhead camshaft	
LUBRICATION		
Type	Wet sump	
IGNITION - FUEL FEED SYSTEM		
Type	Eldor EM2.0 "NEMO" integrated ignition-injection system with Mikuni Motorised throttle body; inductive discharge electronic ignition; "Multipoint" phased sequential electronic injection.	
Spark plugs (alternative)	NGK CR9 EKB	
Spark gap (mm)	0,7 ÷ 0,8	
CLUTCH		
Type	Multiple-disc in oil bath	
PRIMARY DRIVE		
Number of teeth on countershaft gear	Z = 19	
Number of teeth on clutch gear	Z = 36	
Transmission ratio	1,89	
SECONDARY DRIVE		
Number of teeth on front sprocket	Z = 16	
Number of teeth on rear sprocket	Z = 43	
Transmission ratio	2,69	
TRANSMISSION		
Type	Removable, six-speed gearbox with constant-mesh gears	
Gear ratios (total ratios)		
1 st	2.85 (14.493)	
2 nd	2.13 (10.821)	
3 rd	1.78 (9.053)	
4 th	1.58 (8.040)	
5 th	1.43 (7.274)	
6 th	1.32 (6.712)	
FRAME		
Type	CrMo steel tubular trellis (MAG welded)	CrMo steel tubular trellis (TIG welded)
Fork fulcrum plates	Aluminium alloy	
FRONT SUSPENSION		
Type	"Upside down" telescopic hydraulic fork with external and separated adjustment of rebound and compression damping and of spring preload	
Ø stems (mm)	43	
Telescopic movement (mm)	125	120
REAR SUSPENSION		
Type	Progressive, single shock absorber with extension, with compression and spring preload adjustment	
Wheel travel (mm)	123	107
Swingarm	Aluminium alloy	
FRONT BRAKE		
Type	Dual floating disc with steel braking band	
Ø Discs (mm)	320	
Disc flanges	Aluminium	
Calipers (Ø pistons mm)	Radial-type, with 4 pistons (Ø 32)	Radial monobloc, with 4 pistons (Ø 32)
REAR BRAKE		
Type	Single steel disc	
Ø Discs (mm)	220	
Calipers (Ø pistons mm)	2-piston (Ø 34)	
FRONT RIM		
Material	Aluminium alloy	Forged aluminium alloy
Dimensions	3,50" x 17"	
REAR RIM		
Material	Aluminium alloy	Forged aluminium alloy
Dimensions	5,50" x 17"	



Maintenance

TECHNICAL DATA

Description	F3 675	F3 ORO
TYRES		
Front	120/70 ZR 17 M/C (58 W)	
Rear	180/55 ZR 17 M/C (73 W)	
Brand and type	PIRELLI - Diablo Rosso Corsa	
Tyre pressure (*)		
Front	2.3 bar (33 psi)	
Rear	2.3 bar (33 psi)	
ELECTRICAL SYSTEM		
System voltage	12V	
Headlight bulb	H4 12V 60/55W	
Front turn indicator	H6W 12V 6W	
Rear turn indicator	H6W 12V 6W	
Tail light bulb	W5W 12V 5W	
Brake, rear light	W16W 12V 16W	
Battery	12V - 8,6Ah	
Alternator	350 W at 5000 r.p.m.	
BODYWORK		
Fairing	Thermoplastic material	Thermoplastic material
Front fairing	Thermoplastic material	Thermoplastic material
Front fairing spoiler	Thermoplastic material	Thermoplastic material
Rear side panels	Thermoplastic material	Thermoplastic material
Fuel tank	Thermoplastic material	Thermoplastic material
Air scoops	Thermoplastic material	Thermoplastic material
Air-box	Thermoplastic material	Thermoplastic material
Air box side panels	Thermoplastic material	Carbon fiber
Front mudguard	Thermoplastic material	Carbon fiber
Chain guards	Thermoplastic material	Carbon fiber
Exhaust pipe guard	Aluminium	Aluminium
Coverage swingarm	Thermoplastic material	Carbon fiber
Sprocket cover	Thermoplastic material	Carbon fiber
Bulkhead under-seat	Thermoplastic material	Thermoplastic material
License-plate holder	Thermoplastic material	Thermoplastic material
Rear mudguard	Thermoplastic material	Carbon fiber

* : If tyre brands other than those recommended are used, refer to the tyre pressure indicated by the manufacturer on the tyre side wall.



Maintenance



PERIODICAL MAINTENANCE SCHEDULE

The table that follows indicates the recommended intervals between periodical maintenance operations. Periodical maintenance is necessary to keep the motorcycle in an optimum condition. The intervals are expressed in kilometres.

WARNING For motorcycles used in particularly severe conditions, maintenance operations must be carried out more frequently.

We respect and defend the environment. Everything that we do has repercussions on the whole planet and on its resources. MV Agusta, to protect the interests of the everyone, ask clients and technical assistance operators to use the motorcycle and dispose of its used parts with respect to the norms in force in terms of environmental pollution, disposal and recycling of refuse.

Programmed maintenance schedule

Km (mi) covered		0	1000 (600)	6000 (3800)	12000 (7500)	18000 (11200)	24000 (14900)	30000 (18600)	36000 (22400)
Service		Pre-delivery	A	B	C	D	E	F	G
Description	Operation								
Engine oil	Substitution		●	●	●	●	●	●	●
At least once a year									
Engine oil filter 	Substitution (utilise only original MV Agusta oil filters)		●	●	●	●	●	●	●
At every substitution of engine oil									
Engine coolant	Check level and top-up	●	●	●	●	●	●	●	●
	Substitution	At least every two years							
Cooling system	Check for leakages	●	●	●	●	●	●	●	●
Electric fans	Check functioning	●	●	●	●	●	●	●	●
Valves 	Check / adjustment				●		●		●
Timing chain	Check				●		●		
	Substitution								●
Mobile timing chain guide	Check / Substitution				●		●		
	Substitution	At least every substitution of the timing chain							
Timing chain tensioner	Check / Substitution				●		●		●
Spark plugs	Check / Substitution			●		●		●	
	Substitution				●		●		●
Fuel filter	Check / Substitution				●		●		●
Throttle body 	Check and adjust		●	●	●	●	●	●	●
Air filter	Check / Substitution			●	●	●	●	●	●
Brake and clutch fluid	Check level	●	●	●	●	●		●	●
	Substitution						●		
At least every two years									
Brakes and clutch	Check functioning	●	●	●	●	●	●	●	●
	Check circuit	●	●	●	●	●	●	●	●
Brake pads (front and rear)	Check / Substitution		●	●	●	●	●	●	●
Fuel tubes	Check for defects and leakages		●	●	●	●	●	●	●
	Substitution	At least every three years							
Throttle control	Check functioning	●	●	●	●	●	●	●	●
	Check/adjust play	●	●	●	●	●	●	●	●
Choke control	Check functioning	●	●	●	●	●	●	●	●



Maintenance

Programmed maintenance schedule

Km (mi) covered		0	1000 (600)	6000 (3800)	12000 (7500)	18000 (11200)	24000 (14900)	30000 (18600)	36000 (22400)
Service		Pre-delivery	A	B	C	D	E	F	G
Description	Operation								
Transmission and flexible controls	Check / adjust	●	●	●	●	●	●	●	●
Drive chain	Check / adjust	●	●	●	●	●	●	●	●
	Lubricate		●	●		●		●	
	Substitution				●		●		●
Front sprocket / stop washer	Check		●	●		●		●	
	Substitution				●		●		●
At least at each substitution of the transmission chain									
Rear sprocket	Check		●	●		●		●	
	Substitution				●		●		●
At least at each substitution of the transmission chain									
Rear sprocket spring drive	Check / Substitution				●		●		●
Steering bearings	Check		●		●		●		●
	Lubricate						●		
Tyres	Check pressure	●	●	●	●	●	●	●	●
	Check for wear		●	●	●	●	●	●	●
Wheel rims	Visual check		●	●	●	●	●	●	●
		Every tyre substitution							
Front wheel bearings	Check			●	●	●	●	●	
	Every tyre substitution								
	Substitution								●
Side stand	Check functioning	●	●	●	●	●	●	●	●
Side stand switch	Check functioning	●	●	●	●	●	●	●	●
Rear wheel hub	Check / lubricate roller bearings				●		●		
	Substitution / lubricate roller bearings								●
Swingarm bearings	Check / lubricate								●
Drive chain pads on swingarm	Check / substitution		●	●	●	●	●	●	●
Drive chain pads on frame plate	Check / substitution		●	●	●	●	●	●	●
Rear shock absorber	Check / adjust		●		●		●		●
Front fork oil	Substitution						●		
Battery connections	Check and clean		●	●	●	●	●	●	●
Electrical system	Check functioning	●	●	●	●	●	●	●	●
Instruments	Check functioning	●	●	●	●	●	●	●	●
Lights / visual signals	Check functioning / Lamp replacement	●	●	●	●	●	●	●	●
Horn	Check functioning	●	●	●	●	●	●	●	●
Front headlight	Check functioning	●	●	●	●	●	●	●	●
	Adjust	At every variation of the riding set-up of the motorcycle							
Ignition switch	Check functioning	●	●	●	●	●	●	●	●
Locks	Check functioning	●	●	●	●	●	●	●	●
Torque settings - nuts and bolts	Check / tighten	●	●	●	●	●	●	●	●
Tube band fasteners	Check / tighten	●	●	●	●	●	●	●	●
General lubrication		●	●	●	●	●	●	●	●
General check		●	●	●	●	●	●	●	●

B



Maintenance

Table of lubricants and fluids

Description	Recommended product	Specifications
Engine oil	eni i-Ride moto2 5W-40 (*)	SAE 5W/40 - API SL
Engine coolant	AGIP ECO - PERMANENT	Ethylene-glycol diluted with 50% distilled water
Brake and clutch fluid	Agip Brake 4	DOT4
Chain lubrication oil	D.I.D. CHAIN LUBE	-

*: To find the recommended product, MV Agusta suggests going directly to the authorised MV Agusta dealers. Eni i-Ride moto2 5W/40 has been manufactured for the F3 engine. If the described oil is not available, MV Agusta suggests using completely synthetic oils with characteristics equal or better than the ones prescribed in the following standards:

- Conforming to API SL
- Conforming to ACEA A3
- Conforming to JASO MA, MA2
- Grade SAE 5W-40



NOTE The above specifications indicated are marked either on their own or together with others on the container of the lubricating oil.

MAINTENANCE AND TUNING OPERATIONS

Each operation of periodical maintenance is described in this chapter.

ENGINE OIL AND OIL FILTER

Engine oil

Substitute:→ at the first 1000 kilometres and then every 6000 kilometres.

Oil filter

Substitute:→ at the first 1000 kilometres and then every 6000 kilometres (or at least every oil change).

To accede to the oil filter and the discharge and filling holes of the engine oil, it is necessary to carry out certain operations beforehand:

- Position the motorcycle on the rear stand.
- Remove the under fairing (see Chap. C-Body-work).

NOTE The substitution of the engine oil must be done with a hot engine as opposed to the oil-check that is done with a cold engine.

Remove filler cap (1) on the rh side of the vehicle so allow the oil to drain out (see figure).

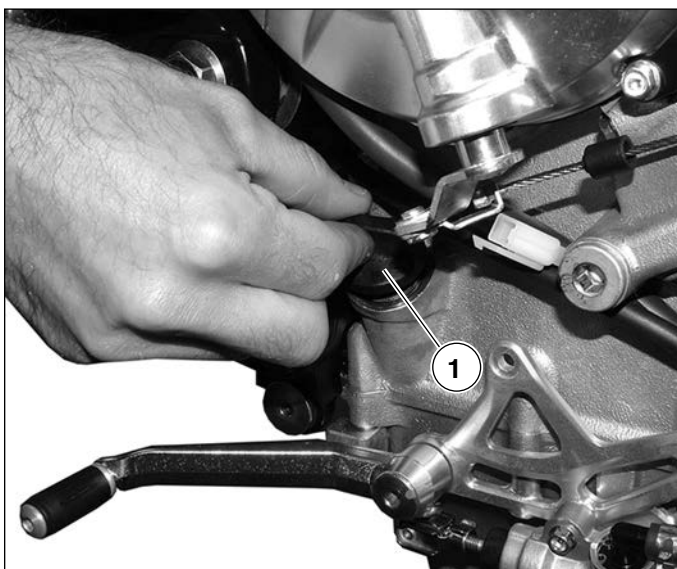



Maintenance

Place a container underneath the engine to collect the used oil.

 Remove the oil discharge plug (1).

Recover the oil in an appropriate container. Do not scatter the drainage oil into the environment.

Allow the lubrication system to drain completely.

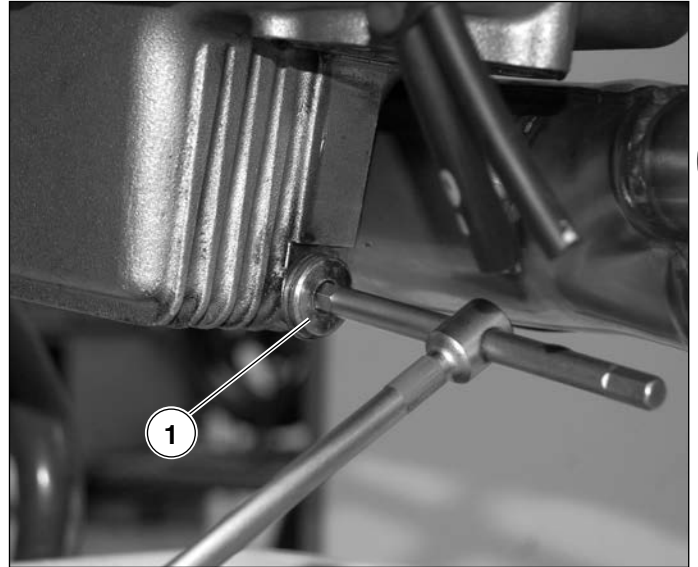

Substitution of the oil filter

Remove the 4 fixing screws (2) of the oil filter cover.

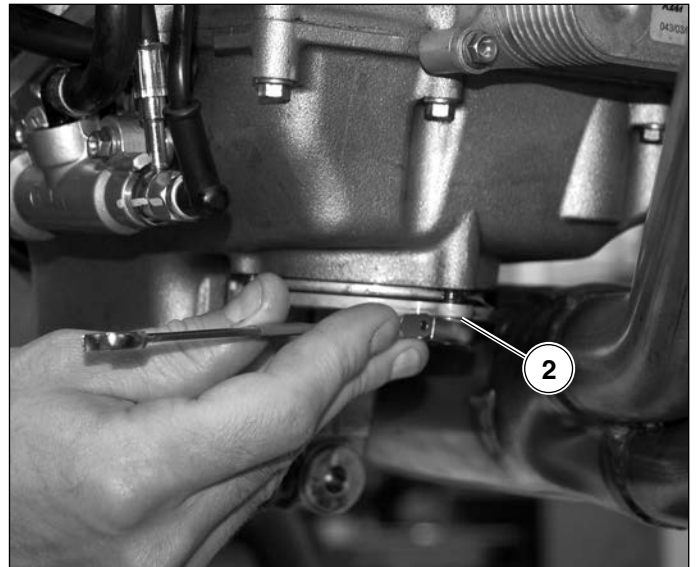

Remove the cover and take out the oil filter.





Maintenance

Replace the oil filter and put the cover back on.



**Torque pressure for cover oil filter screws:
10 N·m**

B

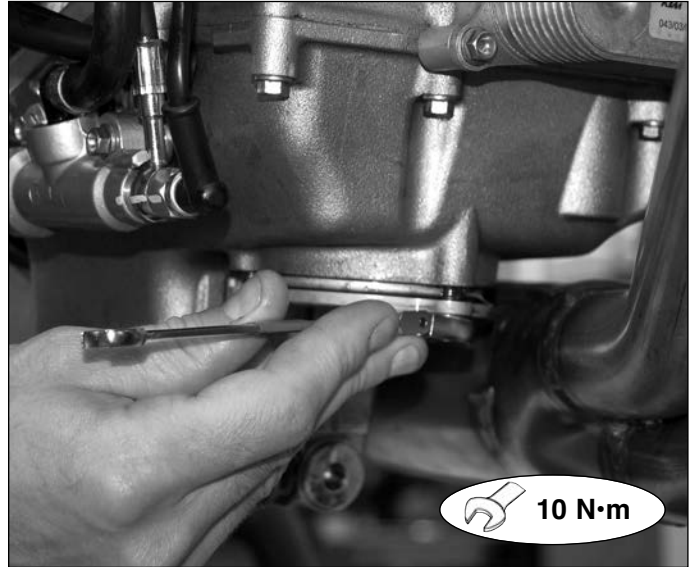

On the oil discharge plug there is a magnet to attract any metal residues that could form in the engine during rotation.

Before replacing the cap, make sure it is completely clean. Replace the sealing washer with a new one.

Screw in the oil discharge plug and tighten it to the specified torque.



Torque pressure oil discharge plug: 40 N·m



Pour around 2 kg of engine oil (as specified in the table on page B-8) into the filling hole.

Close the filler hole using the appropriate cap.

Before replacing the filler cap, grease the O-ring (1) with silicone grease (see figure).

Tighten the cap (2).

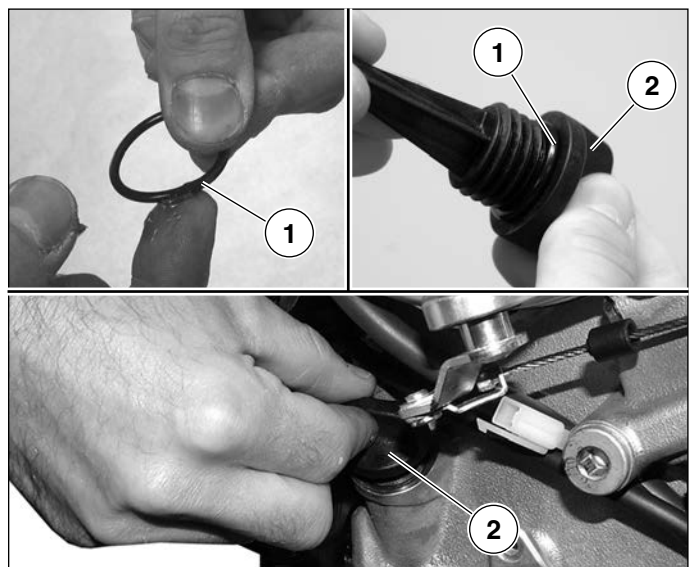



Maintenance

Switch on the engine for several minutes.
After switching off the engine, wait at least ten minutes and then check the oil level.
Ensure that the motorcycle is placed on level ground and is in a vertical position.
The level must be within the "MIN" and "MAX" references marked on the cap rod. Do not exceed the "MAX" marking. Check any oil leakages.



Avoid turning the engine over with the oil level lower than minimum. It could compromise the correct functioning of the engine. If the level after the topping-up, is over the "MAX" reference notch, correct it by emptying a little oil out of the engine.

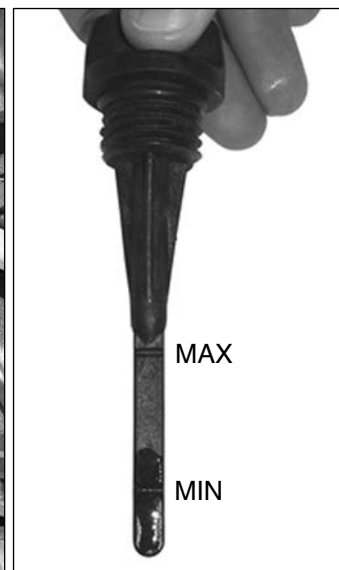

Oil pipes

During ordinary maintenance operations, ensure that the different components are properly fitted and that no oil is leaking from the parts involved in engine lubrication and in particular from:

- The crankcase.
- The oil feed pipes connecting the oil pump to the cylinder head.



If even the slightest leakage is found, overhaul the components as described in the F3 engine workshop manual (Part. Cod. 8000B6035).



ENGINE COOLANT

Check / top-up level →

At the pre-delivery, at the first 1000 kilometres and then every 6000 kilometres.

Keeping the motorcycle in a vertical position, check that the coolant liquid level is above the "MIN" level marked on the side of the expansion tank (1).

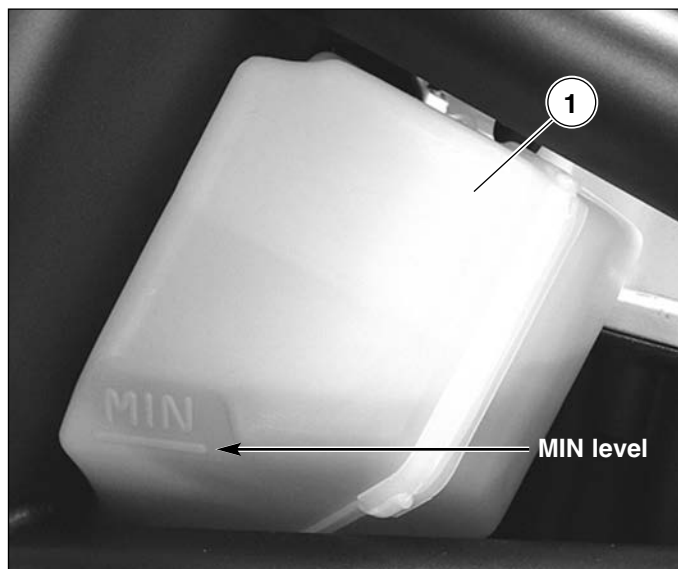



Maintenance

If the level is under the minimum line, proceed with top-ping-up as follows:

B With the engine cold, unscrew and remove the coolant filler cap (2). Using a syringe, top up with the recommended coolant on page B-8.

 **Open the expansion tank only when the engine is cold; the discharge of boiling liquid could cause burns.**
If the liquid comes into contact with the skin or the eyes, rinse abundantly with water.



Engine coolant substitution

Substitution → every two years

Before proceeding the emptying of the system, remove:

- the left under fairing;
- the left and right side fairing (see chapter C "Bodywork");
- tail side panels;
- fuel tank;
- place a container under the engine to collect the used coolant;
- remove the drain screw (1) of the engine coolant liquid;
- open the radiator filler cap;
- drain off the liquid paying attention to the jet.

Wait for the engine coolant to completely flow out.

Position the motorcycle on the side stand.

Fill the cooling system with a suitable liquid described in the table (see page B-8) until you reach the level of the bar of the radiator filler cap. Do this in stages to stabilise the liquid level.

Close the cap and bring the motorcycle back to a vertical position on the rear stand.

Fill up the expansion tank until it exceeds the "MIN" level.

Switch on the engine and keep it running until the water becomes hot enough to automatically switch on the electric cooling fan. Switch off the engine. Repeat the operation at least once, then wait some minutes for the engine to cool down.



Carefully check for leaks, blow-bys, damaged tubing, etc. If there are leaks or damage in the cooling system, proceed with the overhaul as described in the chapter L "Cooling system".

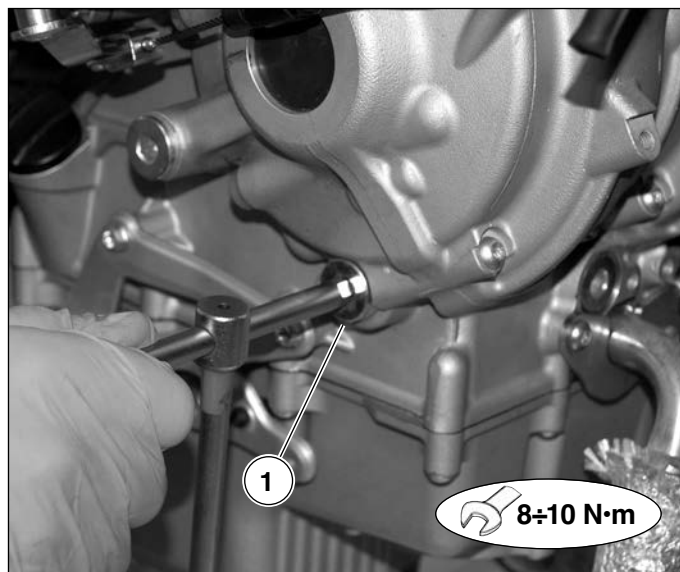

B



Maintenance

Check once again the level of the coolant inside the expansion tank.

This must reach a position above the "MIN" line marked on the expansion tank.

If the level is inferior to the «MIN» mark, top up the coolant level by pouring new coolant into the filler hole.

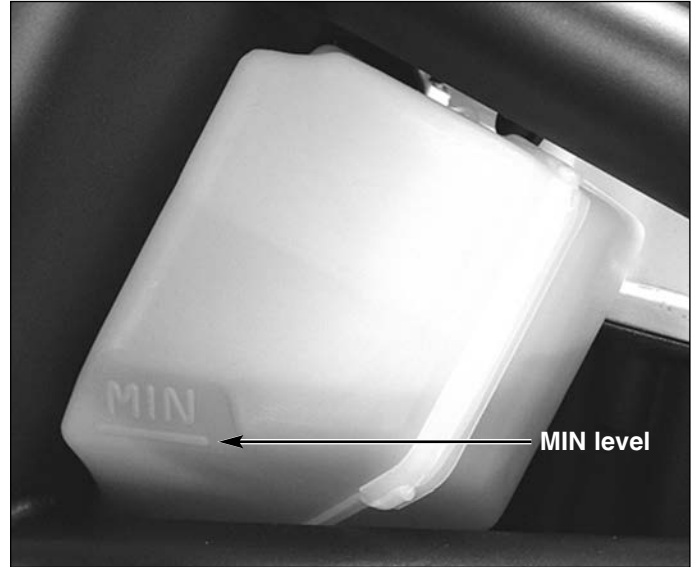

Complete the assembly of the motorcycle.



ELECTRIC COOLING FAN

Check → on pre-delivery and at the first 1000 kilometres and then every 6000 kilometres.

To carry out the check on the functioning of the electric cooling fan, switch on the engine and heat it up.

The electric fan must start up when the temperature of the coolant liquid reaches the fourth notch on the dashboard. If the electric cooling fan do not switch on, carry out the checks on the various components as described in chapter L "Cooling system".





VALVE MECHANISM ADJUSTMENT

Check and adjust → at 1000 kilometres and then every 12000 kilometres.

Remove in order the following components to carry out the measuring of the play between the camshaft and the valve cups:

- Under fairing
- Left side fairing panel
- Right side fairing panel
- Front fairing
- Right air intake conduit cover
- Left air intake conduit cover
- Left air intake conduit
- Right air intake conduit
- LH fuel tank side panel
- RH fuel tank side panel
- Saddle
- Rear side panels
- Fuel tank
- Airbox
- Throttle body

NOTE: For all removal operations, including the relative attention notes, please refer to the specific sections in this manual.

An analogous reference is utilised for the reassembly of the parts after the maintenance operation.

After having removed the indicated components, the motorcycle is shown in the condition described by the photograph on side.



Before proceeding with the various maintenance operations, it is advisable to thoroughly wash and clean the motorcycle.

Place the motorcycle (now without the components listed above and clean) on a workstation as indicated in the figure.

Apply adhesive paper tape to the frame tubes.

This operation will protect the paintwork from knocks, scratches and abrasions that could occur during the work activity.

Ensure that all the surfaces of the frame are protected by the application of the adhesive tape.

Apply the same adhesive tape to the air intakes of the engine.



Remove the 3 screws (1) and the clamping bracket (2) for the plug-top coils.

B

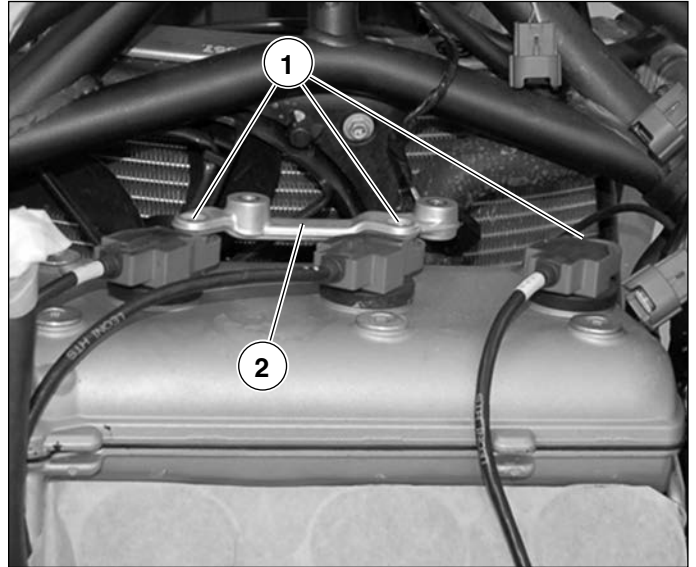

Take the 3 plug-top coils out, as shown in the figure.



Clear the valve cover area (3).
Systemise the HT leads, positioning them as indicated in the following figure.

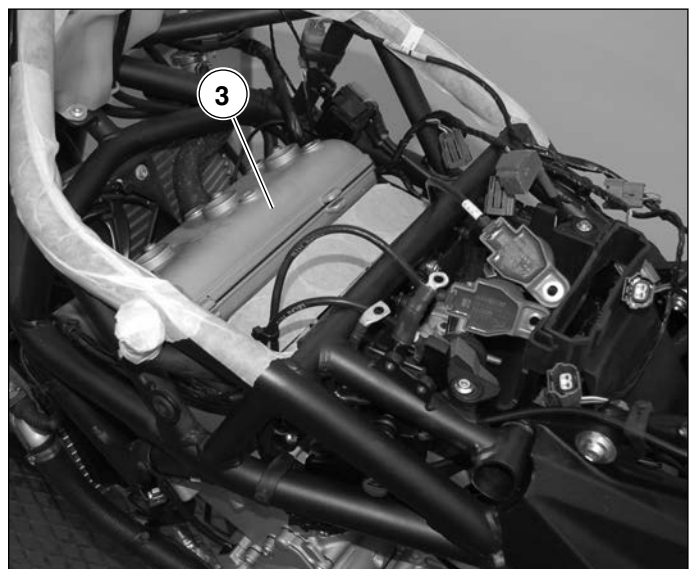



Maintenance

Lift the front part of the motorcycle as shown in the figure.



Remove the 6 screws that hold down the cover of the engine head (4) starting from the centre as shown in the figure.



Operating as shown in the figure, slightly lift up the cylinder head cover.

To carry out this operation, use *only* the work surfaces indicated.

Take care to not ruin or deteriorate the motorcycle parts in the proximity of the work area.

To remove the engine head cover and adjust the play of the tappets see the procedure in the Engine Workshop Manual (Part. Code 8000B6035).

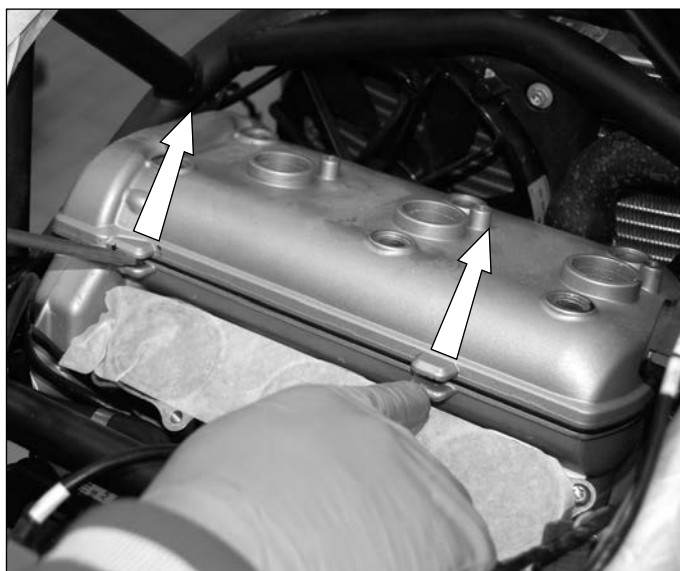



Timing chain, mobile timing chain guide and timing chain tensioner

Timing chain and mobile timing chain guide:

- B** Check → Every 12000 kilometres
Substitute → Every 36000 kilometres

Timing chain tensioner:

- Check / substitute → Every 12000 kilometres

To disassemble these parts and not being a part of normal maintenance, it is necessary to proceed as described in the overhaul section of the F3 workshop engine manual (Part. Cod. 8000B6035).

SPARK PLUGS

- Check/substitute → At 6000 kilometres and then every 12000 kilometres

- Substitute → Every 12000 kilometres

The following components must be removed to accede to the spark plugs:

- Under fairing
- Left fairing side panel
- Right fairing side panel
- Front fairing
- RH wire harness cover
- LH wire harness cover
- Left air intake conduit
- Right air intake conduit
- Saddle
- Right rear side panel
- Left rear side panel
- LH fuel tank side panel
- RH fuel tank side panel
- Fuel tank
- Airbox

Remove the 3 screws (1) and the clamping bracket (2) for the plug-top coils.

Take the 3 plug-top coils out (3).

Remove the spark plugs utilising the appropriate 16 mm hexagonal spark plug spanner.

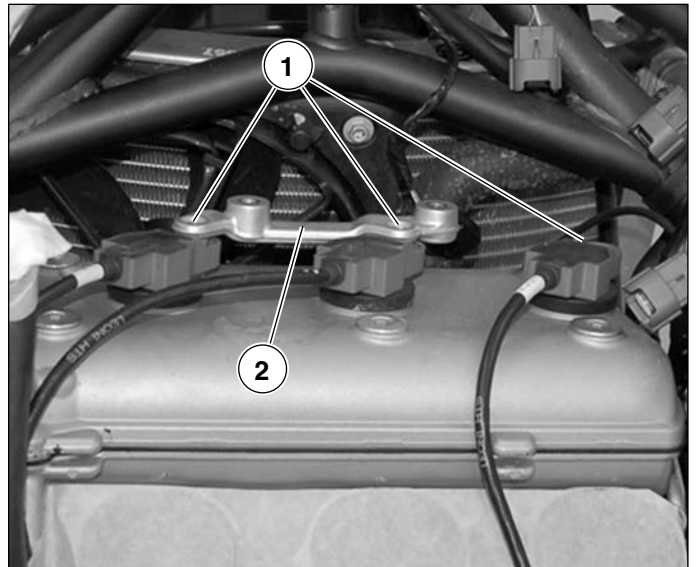



Maintenance

Heat Grade

Check the heat grade of the spark plugs.

Sparks: - NGK CR9 EKB



DO NOT use non-resistive spark plugs.

Spark plug gap

If appropriate (see Technical Data table), measure the spark gap with a thickness metre. Adjust the gap if necessary on the basis of the following information:

Sparks	Spark plug gap
NGK CR9 EKB	0,7 ÷ 0,8 mm

Electrode condition

Check the electrodes for wear or burning. If they are extremely used or burnt, substitute the spark plugs. Also substitute the spark plugs in the case of breakage of the ceramic isolation or damage to threading.



When the spark plugs are renewed, check the thread pitch size and the length of the thread. If the threading is too short, carbon deposits will be placed on the threading of the cylinder head plughole thereby risking damage to the engine.

Manually insert the spark plugs into their seats to avoid damage to the threading of the cylinder head. When completely screwed in by hand, tighten to the specified torque pressure.



Spark plugs torque pressure: 12 N·m

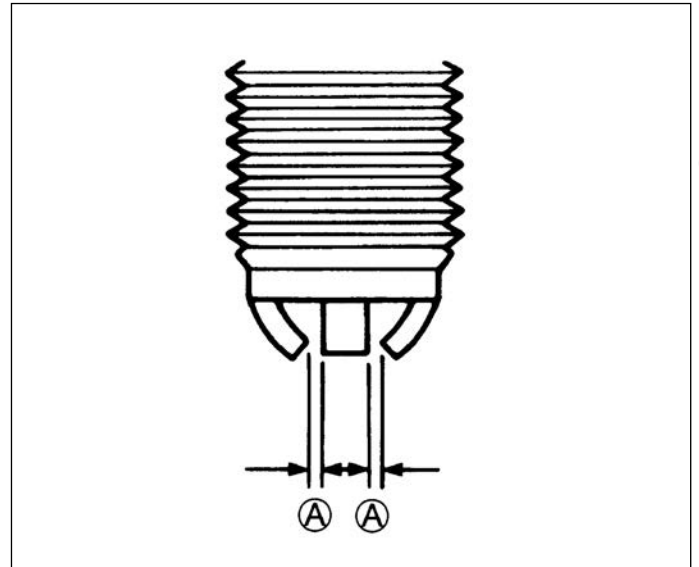

B



FUEL FILTERS

Substitute →

Every 50.000 km

B For the substitution of the engine intake system filters (fuel filter, fuel pump filter), it is necessary to remove in sequence the following parts:

- Saddle
- Radiator side panels
- Airbox side panels
- Tail side panels
- Central side panels
- Fuel tank

NOTE: Consult chapter C “Bodywork”.



Fuel filler cap removal

Insert the ignition key in the fuel filler cap lock and rotate in a clockwise direction to open the fuel filler cap.

Remove the safety screw (1).

Unscrew the 6 clamping screws (2).

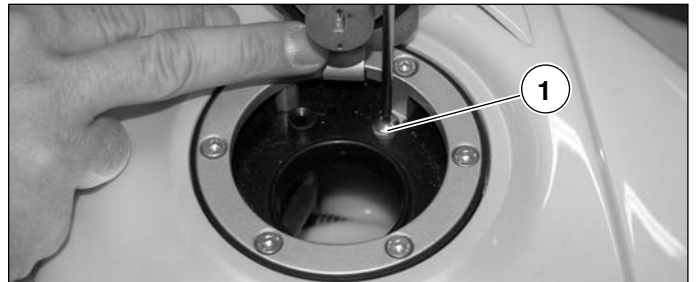

Remove the tank cap.

Empty the fuel tank completely using an auxiliary pump, as illustrated in the figure.

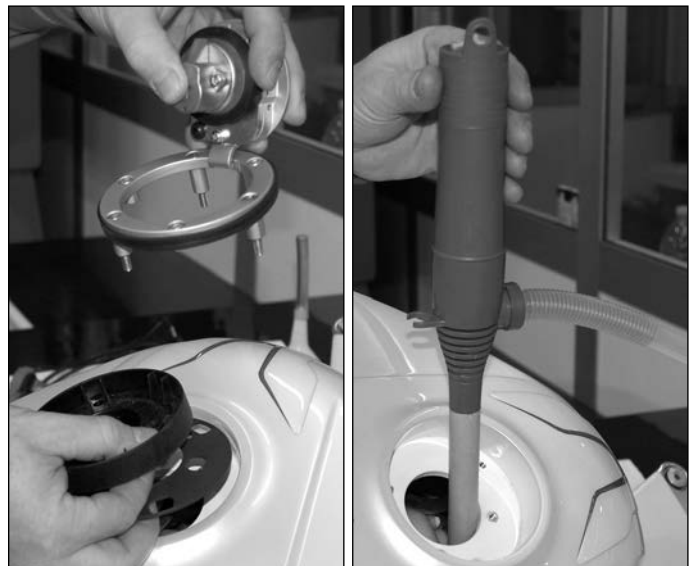



Removing the fuel pump unit

Lift the tank and proceed with the removal of the 6 screws (1) that hold down the retaining flange of the "Fuel pump" unit.

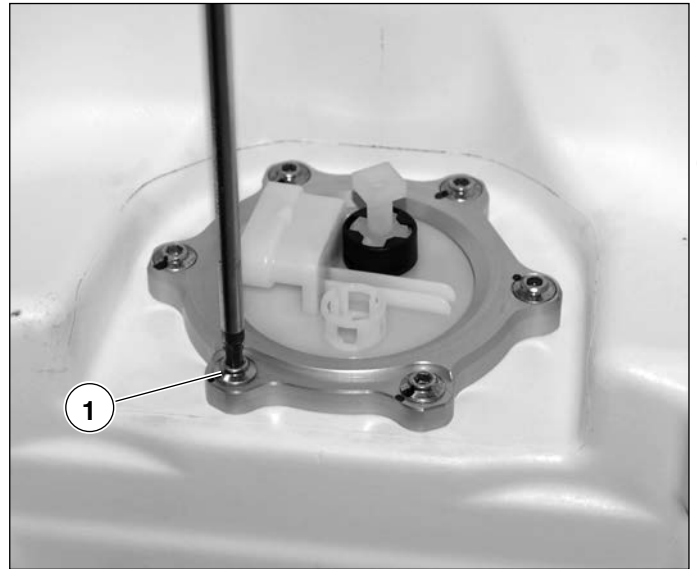

Take the flange (2) out of its place.

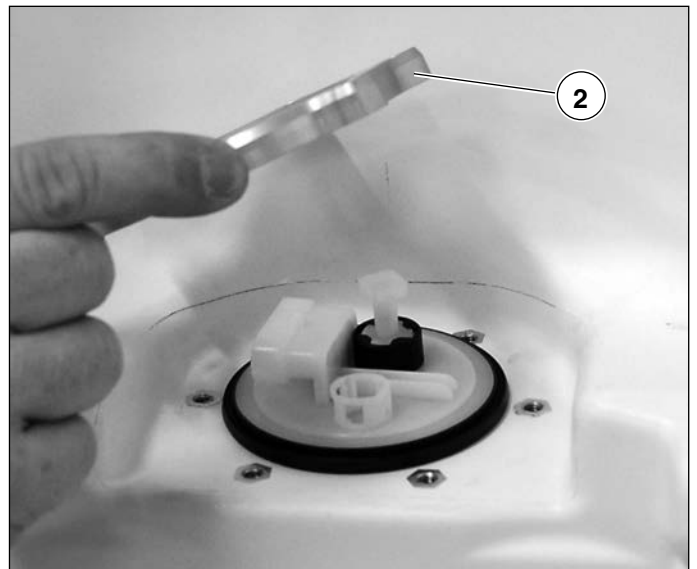

Using a screwdriver open the edge of the gasket and gently create leverage between the gasket and the flange until you feel the unit move.

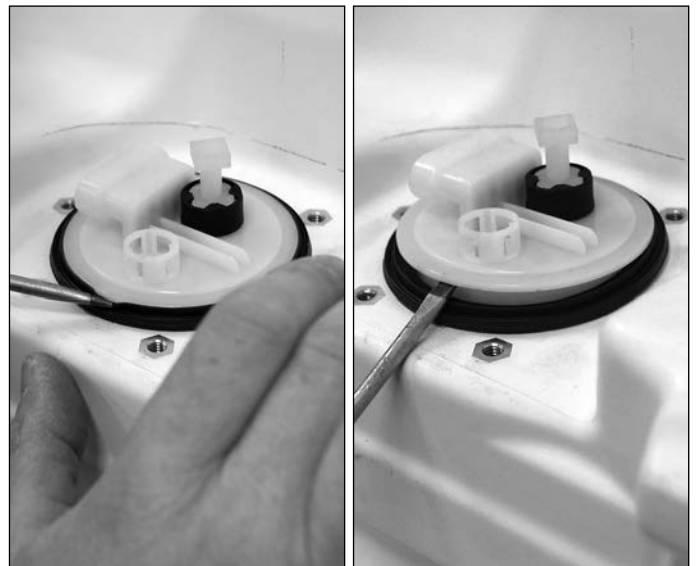

Take the "Fuel pump" unit out by hand.



Check and replace the gasket

Check the state of the sealing gasket (1) on the petrol pump unit.

Make sure that the gasket is perfectly intact and lubricate it by applying silicone grease.

If it is damaged, change it for a new one.



Using a worn gasket can cause petrol to leak from the tank and therefore pose the risk of the vehicle taking fire.



Changing the thermistor complete with cabling

If the thermistor needs to be changed the two self-tapping screws must be taken out (1).

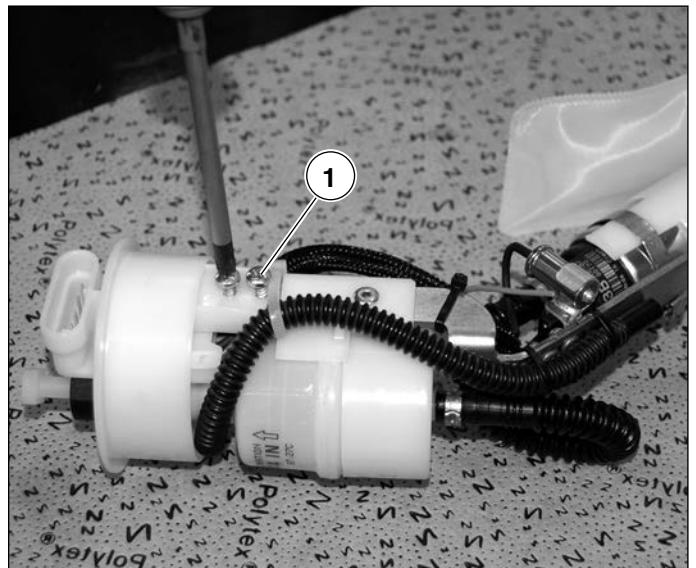



Maintenance

Cut the 2 straps on the electric cabling (2) and (3).

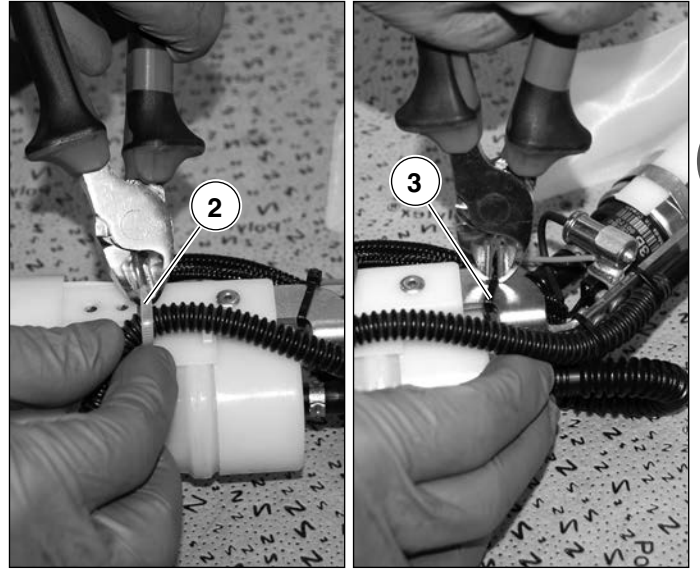

Disconnect the cabling (4) from the probe.

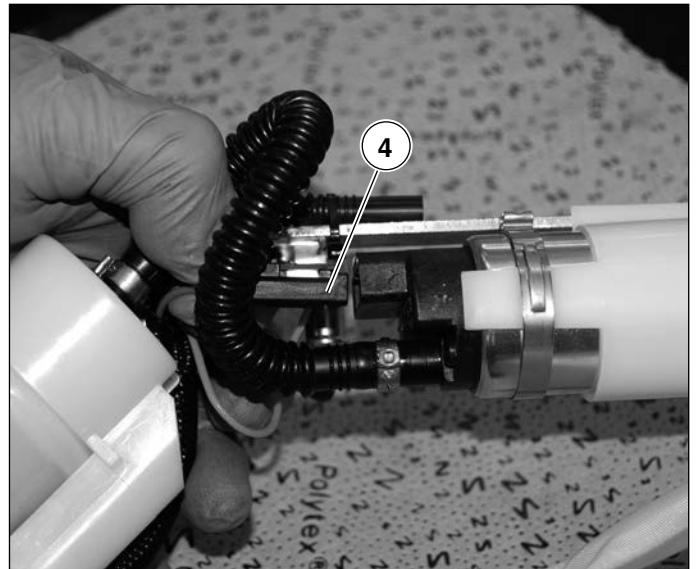

Detach the unit by pulling from both sides.

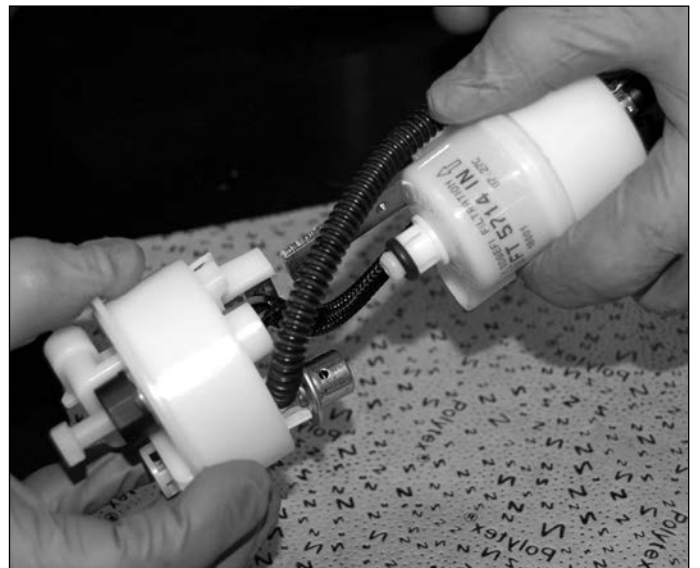

B



Maintenance

Disconnect the cabling from the flange part by lifting the flaps and taking out the connector.

B



Unweld the thermistor from the support bracket.

Replace it with a new part and put it back in place by following the disassembly operations in reverse order.



Replacement the fuel filter

Remove the 2 self-tapping screws (1).

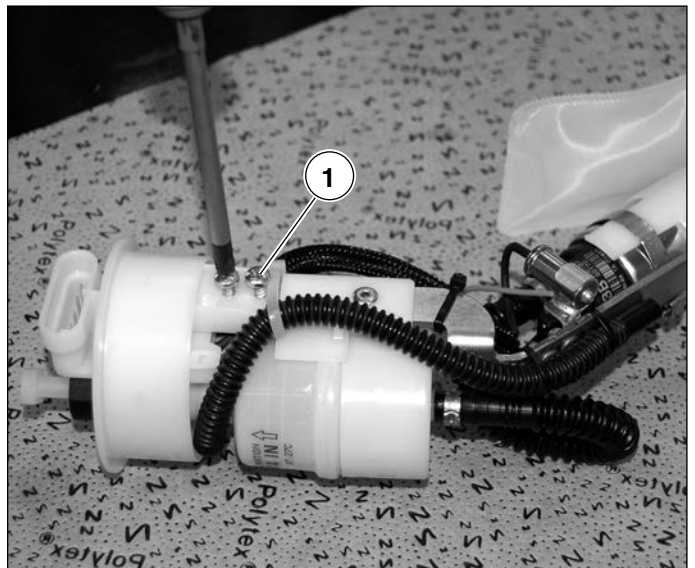



Maintenance

Cut the 2 straps on the electric cabling (2) and (3).

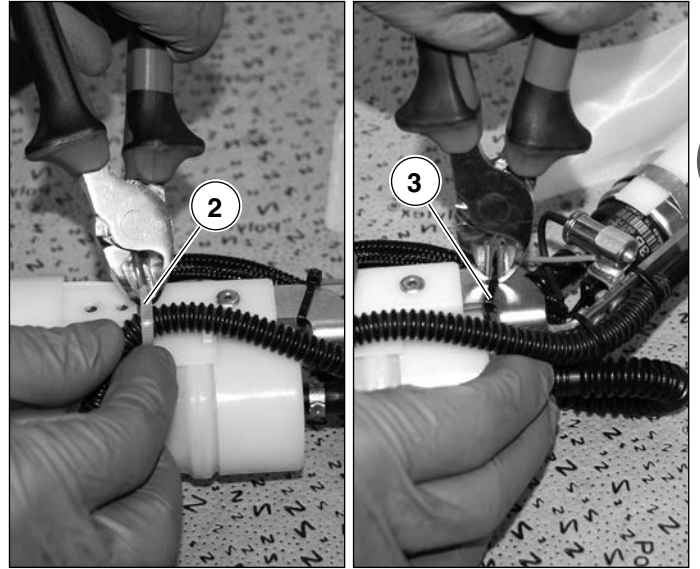

Disconnect the cabling (4) from the probe.

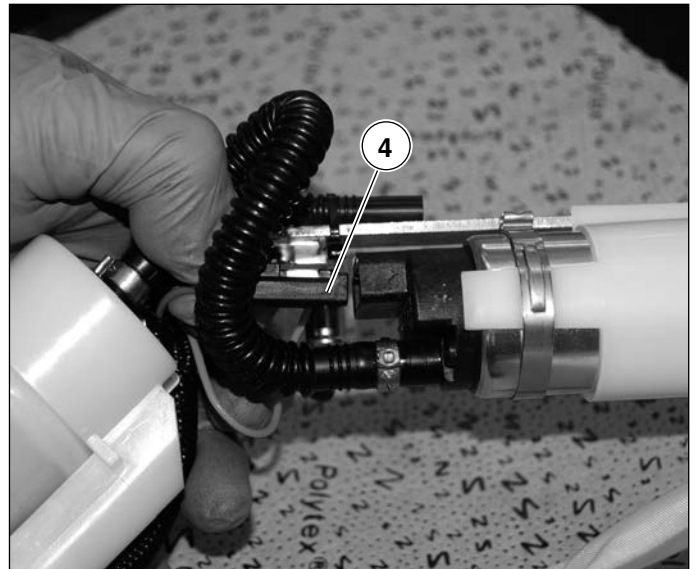

Detach the unit by pulling from both sides.

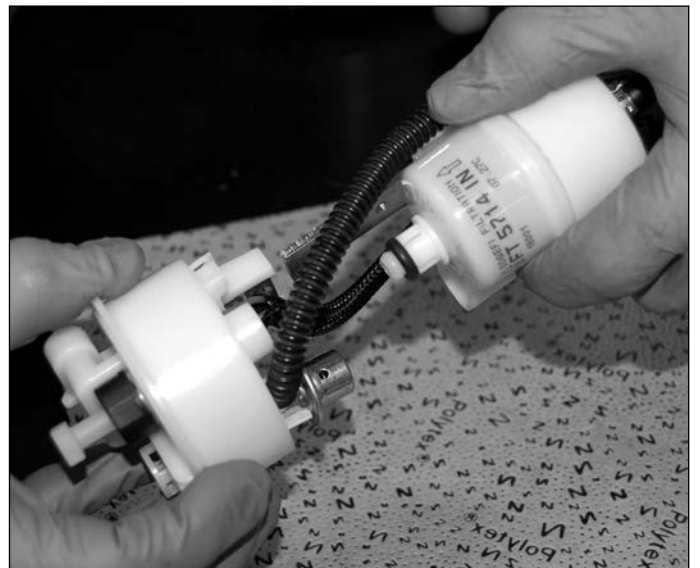

B



Maintenance

To remove the filter take off the strap (5) and slid the tube out (6).

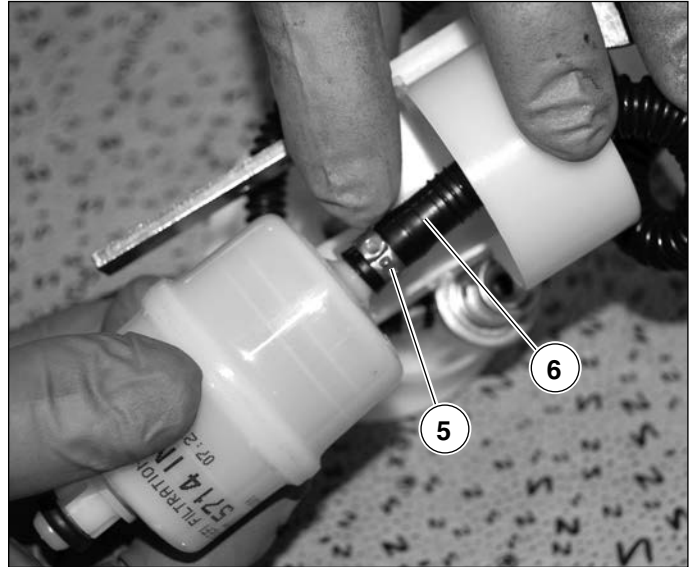

Take the O-ring (7) off of the front of the filter and slid the clamp off (8).

Replace the filter with a new one.



Insert the tube into the new filter and secure it with a new strap taken from the new supply kit, using the required tool.



Pneumatic pincer: Oetiker HO 3000 ME

Put the unit back in place in the reverse order of disassembly using two new straps to secure the electrical cabling in the same position.



FUEL PUMP ASSEMBLY

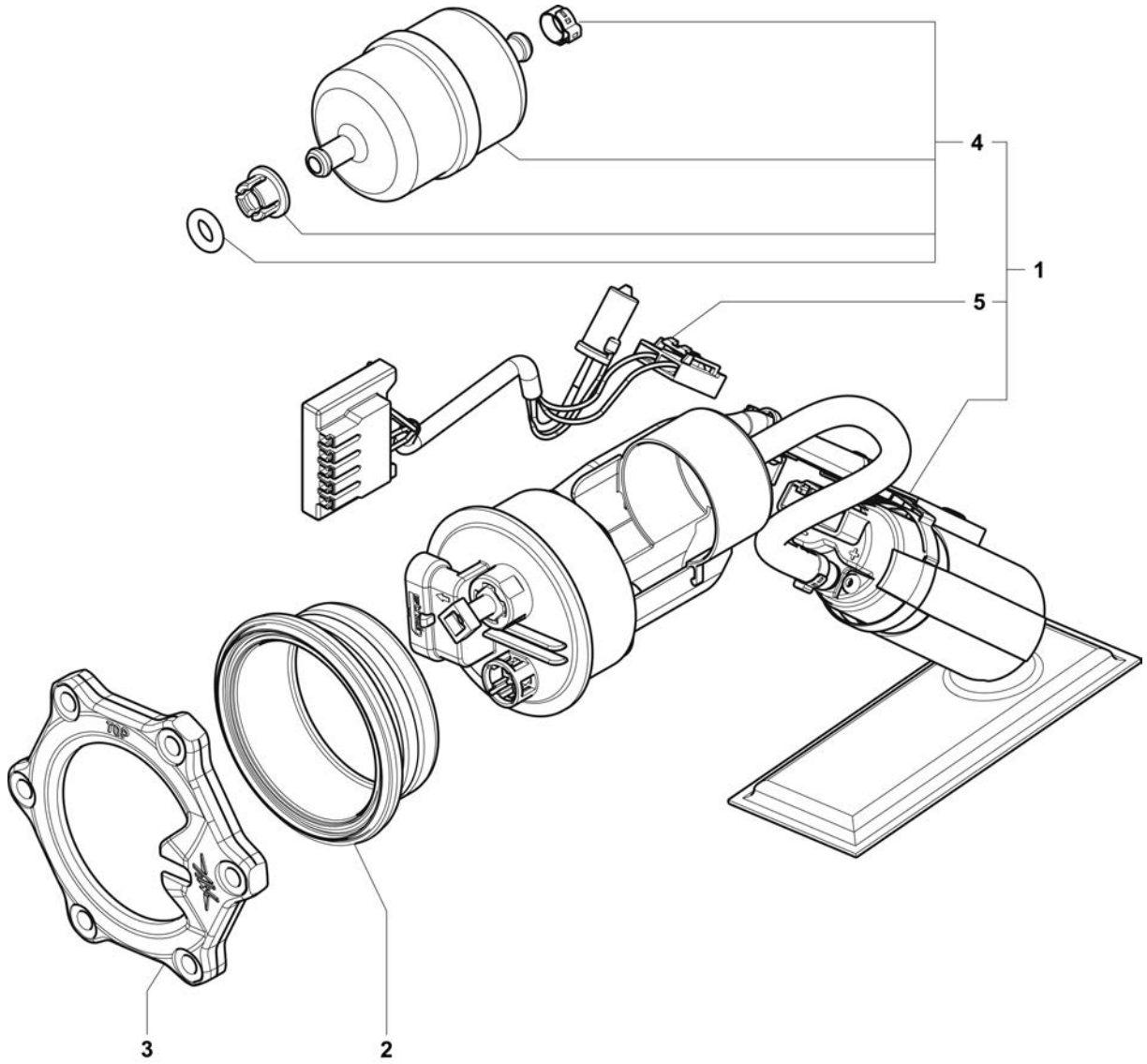

N.	Code	Q.ty	Note	F3 675	F3 ORO	► FRAME ►	► ENGINE ►
1	8000B4722	1		•	•		
2	8000B5991	1		•	•		
3	8000B4723	1		•	•		
4	8000B7161	1		•	•		
5	8000B7162	1		•	•		

Installing the fuel pump unit

Position the fuel pump unit inside the fuel tank.

Be careful of the filter, positioning the electric connector in a vertical position.



Set the flange (1) up on the pump unit aligning it with the threaded holes on the tank.

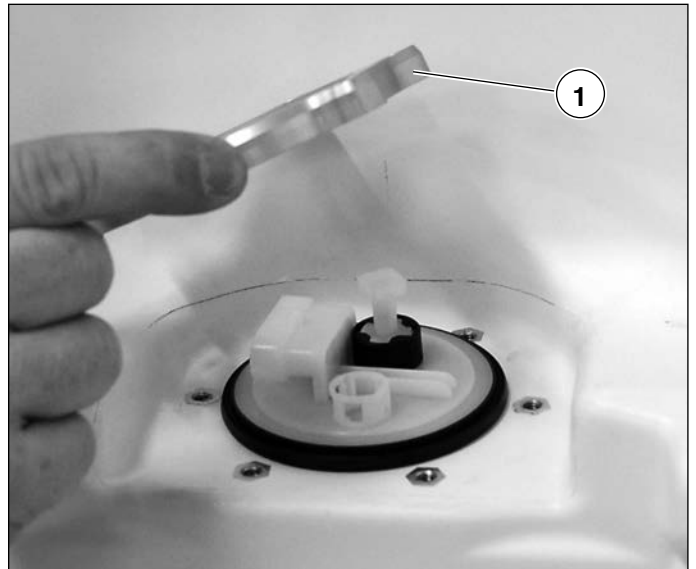

Screw on and tighten the 6 screws (2) through a repeated action.



Torque pressure for the fuel pump flange screws: 6÷8 N·m

Proceed with the re-assembly of the parts that have been removed following the operations in reverse order to disassembly, as described in chapter C "Bodywork".

- Fuel tank
- Central side panels
- Tail side panels
- Airbox side panels
- Radiator side panels
- Saddle





TUBES / FUEL FITTINGS

Check for leaks → First 1000 kilometres and then every 6000 kilometres

Carry out a visual check for eventual leakages from the fuel feed tubing and the unions (see figure). Substitute damaged parts if leaks or evaporation are found.

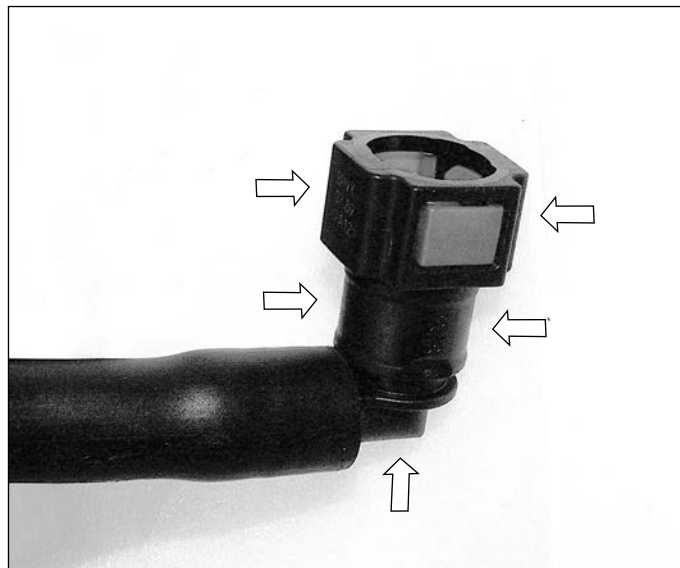

Replacement the main fuel tube

Substitute → At least every three years

The procedure to follow in the case of substitution of the feed tubing is as follows:

Remove in this order:

- Left under fairing
- Left side fairing
- Right and left fuel tank side panels
- Saddle
- Right and left tail side panels

Disconnect the main tube from the tee-fitting.





Maintenance

Lift the tank and disconnect the electrical connection to the pump unit (see chapter C Bodywork).

B



Put the tank down and disconnect the main fuel tube from the pump by pressing the black ring nut downwards.



Put the new main fuel tube in the pump flange until it locks in.



UTILISE ONLY NEW PARTS.



Replacement the Rails fuel pipe connection

Replacement → At least every 3 year

If the main Rails fuel pipe needs to be replace, the following procedure must be carried out:

Remove in the order:

- Left under fairing
- Left side fairing
- Right and left fuel tank side panels
- Saddle
- Right and left tail side panels

Disconnect the supply tube to the top Rails.



Remove the 2 cable-retaining straps.



Disconnect the 3 injector connectors.



Disconnect the air temperature sensor.



Take down the Airbox (see procedure in chapter C "Bodywork").





Maintenance

Disconnect the throttle body pipe from the Rails by pressing the two stop flaps and sliding the pipe off.

Insert the new Rails connecting fuel pipe into the fitting installed on the throttle body, until you feel it is locked on.



UTILISE ONLY NEW PARTS.



B



CHECKING ENGINE DURING IDLE

The engine control unit is designed to adjust the torque issued by the engine during idle.

B Set up the connection between the control unit and the diagnostic software. With the engine warm and the fans on, in idle, in neutral, observing the following parameters through the diagnostic software within the recommended intervals, you are able to control the operation of the correct motor.

F3 675 – F3 ORO:

Engine rpm	1400 ± 200 rpm	
Adaptive lambda check	min -0,15	max +0,15
Suction pressure	500 ± 100 mbar	
Engine load	25 ± 10 %	
Throttle capacity adaptability	min - 2%	max +2%

Operation outside of the recommended intervals is a sign that the engine is not running correctly.

If the recommended intervals are not being maintained, it is a good idea to proceed with the following checks in order to find the cause that is making the engine operate outside of the intervals provided above:

- checking, with a diagnosis, the validated system errors;
- checking the petrol pressure and making sure the injectors are working;
- making sure the throttle body is working correctly;
- making sure the exhaust is working correctly (correct installation, holes, leaks, the state of the catalyst, etc);
- checking engine phase.



Maintenance

Air Filter

Check/substitute → Every 6000 kilometres

Certain parts must be removed in sequence before accessing the air filter. See chapter C "Bodywork".

- Left fairing side panel
- Front fairing
- Left air intake conduit cover
- Left air intake conduit



Remove the air filter (1) by sliding it out from the left airbox intake hole.

Check the condition of the air filter. If it is necessary to substitute it, proceed as follows:

Prepare a new air filter.

Check that the inside of the air filter compartment is clean and free from foreign bodies.

Insert the air filter, respecting the correct way of assembly, as shown in the figure.



Proceed with the assembly of the parts listed below and according to the procedure described in chapter C "Bodywork".

- Left air intake conduit
- Left air intake conduit cover
- Front fairing
- Left fairing side panel





BRAKES

Check the levels of fluid in the systems

At pre-delivery, at first 1000 kilometres and then every 6000 kilometres.

Check for leakages

At pre-delivery, at first 1000 kilometres and then every 6000 kilometres.

Substitute fluid

Every 24000 kilometres or at least every two years.

Commands check

At pre-delivery, at the first 1000 kilometres and then every 6000 kilometres.



Checking the front brake fluid level

The procedure described below must be followed for the front brake fluid tank.

Place the motorcycle in a vertical position with the handlebars straight.

Check the level of fluid in the brake tank by observing the level marking lines inside the tank itself.

If the level of the fluid is lower than the lines marked on the chambers, add recommended brake fluid according to the procedure indicated as follows:

- remove the clamping screw (1) from the safety plate (2);
- remove the oil tank cap (3) and the 2 elements positioned under it.

It is advisable to remove the window from the front cowl to have more space to move.

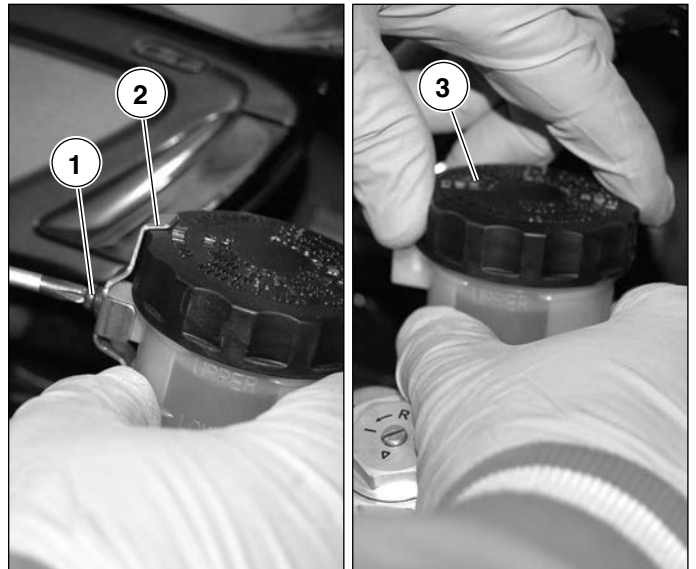

Add brake fluid until the correct level is reached in the chamber.



Recommended brake fluid: AGIP Brake 4



Do not use brake fluid that comes from old containers, has already been used or does not come from a sealed container. Do not use brake fluid that is left over from previous maintenance or stored for long periods. Utilise only the recommended brake fluids.





Maintenance

Before completing the operation, clean and wash accurately with alcohol the three components of the fluid chamber cover and blow to dry them.

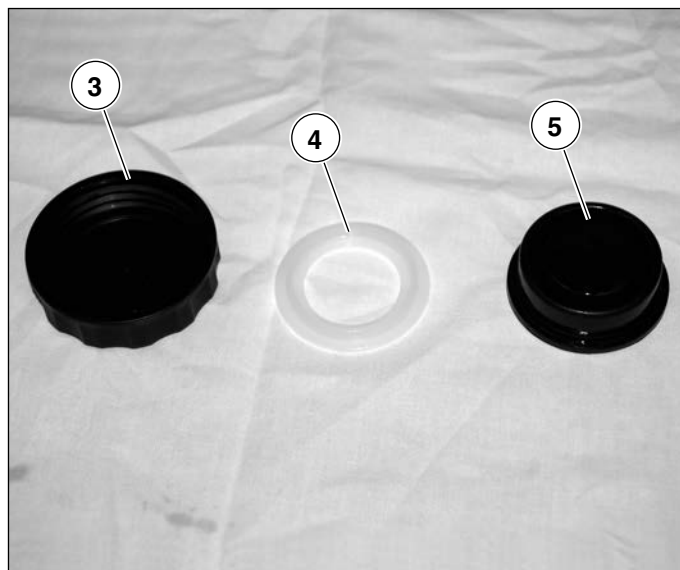

Clean the edge of the fluid chamber with a clean cloth.

Position the parts (4 and 5) on the tray.

Screw the oil tank cap on and put the safety plate back on using the relative clamping screw.



Imperfect cleaning of these parts could cause the discharge of small quantities of brake fluid during riding. Brake fluid has strong corrosive properties.



Check for any leakage or seepage of brake fluid from the fittings and pipes.

If any breakages are seen, substitute the damaged parts as described in chapter H "Brakes".



Brake fluid leakages are dangerous and immediately discolour painted surfaces. Before riding, check the tubes and joints of the brakes for damage and signs of leaks.





Maintenance

Checking the level of the rear brake fluid

No parts of the vehicle need to be removed from the vehicle to check the level of the rear brake fluid.

B

If the fluid is below the low level mark, follow these steps to top up with brake fluid complying with the specifications:

remove the oil tank (1) from the frame plate followed by the tank clamping plate;

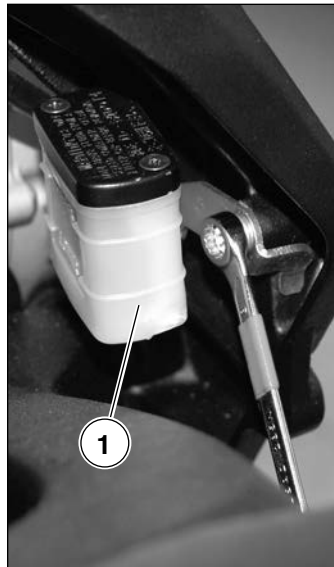

open the cover of the rear brake fluid tank, removing the 2 screws (2);





Maintenance

place the tank with a strap and a protective cloth, securing it to the plate of the frame;



The fluid in the braking circuit is highly corrosive.

Avoid any contact with eyes, skin and mucous membranes.

In case of accidental contact, wash thoroughly with water and consult a doctor.

During the following operations avoid dripping on painted areas.



fill the braking system by acting on the lever of the rear brake;



fill the rear brake fluid tank until it reaches the max level;



Recommended brake fluid: AGIP Brake 4



Do not use brake fluid that comes from old containers, has already been used or does not come from a sealed container. Do not use brake fluid that is left over from previous maintenance or stored for long periods. Utilise only the recommended brake fluids.

clean the entire edge of the brake fluid tank thoroughly, using a clean cloth;



B



Maintenance

Before closing the tank make sure its parts are intact.

Secure the rear brake fluid tank to the plate and then to the frame plate using Loctite with the required torque pressure:

B



Torque pressure: $8 \div 10$ N·m



Apply Loctite Media 243



Substitution and bleeding of the brake fluid

The substitution of the brake fluid and the successive bleeding of the circuit are operations that require particular caution and precision.

To carry out these operations, it is therefore necessary to follow the procedure described in chapter H "Brakes" of this manual.



BRAKE / GEARCHANGE COMMANDS CHECK

It is possible to adjust the position of the front brake lever and the rear brake and gear levers. Such adjustments have been created to optimise the grip and the movement of the commands with regards to the needs of the motorcyclist. The commands of the motorcycle are initially calibrated to a standard position, but can be altered as follows.

Front brake lever adjustment

 **Never carry out adjustments whilst riding the motorcycle.**

Pull the lever to neutralise the push of the spring and at the same time, adjust the position by rotating the ring in a clockwise or anti-clockwise direction.

In a clockwise direction: The lever goes further away from the handgrip.

In an anti-clockwise direction: The lever comes closer to the handgrip.

 **Whenever the command levers do not function correctly or have excessive play, consult chapter H “Brakes” for the overhaul of the same.**



Adjusting the clutch play

In normal conditions, when the engine is cold, the play of the clutch transmission must be ~3 mm at the point shown in the photo.



If the measurement differs by ± 1 mm it is possible to act on the register located on the handlebar control.



For greater differences set the register on the handlebar at the indicated measurement of 22 mm.



Adjust the main register sheltered by the clutch cover by acting on the two nuts, in order to restore the initial play of 3 mm measured on the lever.



Adjusting the rear brake lever F3 ORO

Adjustment on the rear brake lever is carried out by acting on screw (1) which allows the pedal to turn 135°.

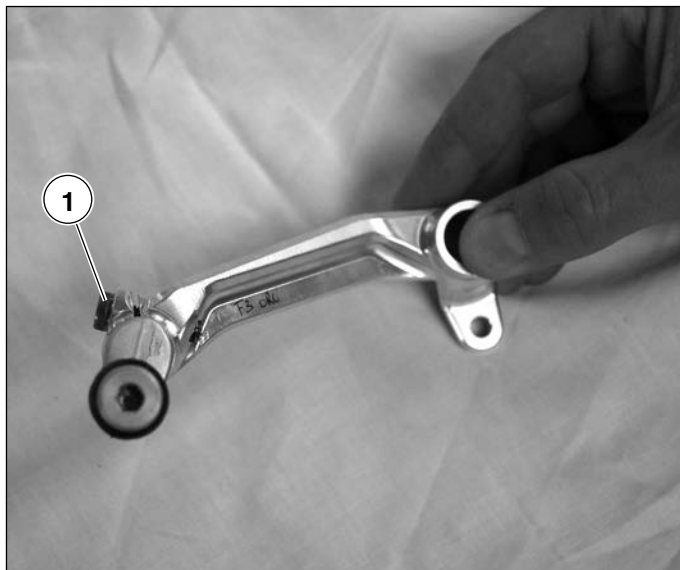

Adjusting the gear lever

To adjust the gear lever it is necessary to:

1) Remove guard (1) by removing the two screws (2).

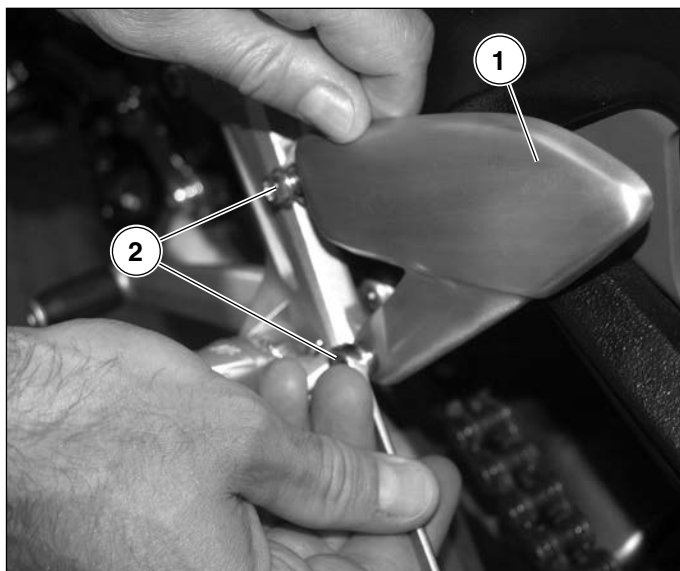

2) Slacken the two counter nuts (3) (rh thread) and (4) (lh thread).

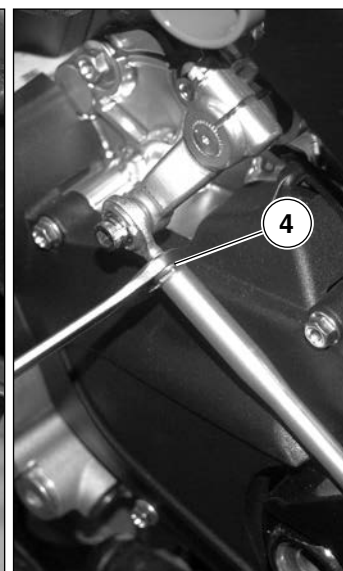
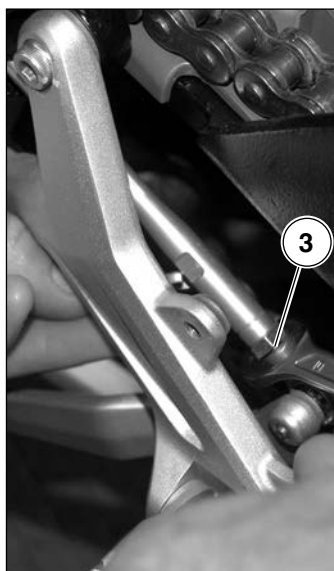

3) Screw/unscrew by hand the gearbox transmission rod **4** until the lever reaches the desired position.

4) Tighten the locknuts and the protection.

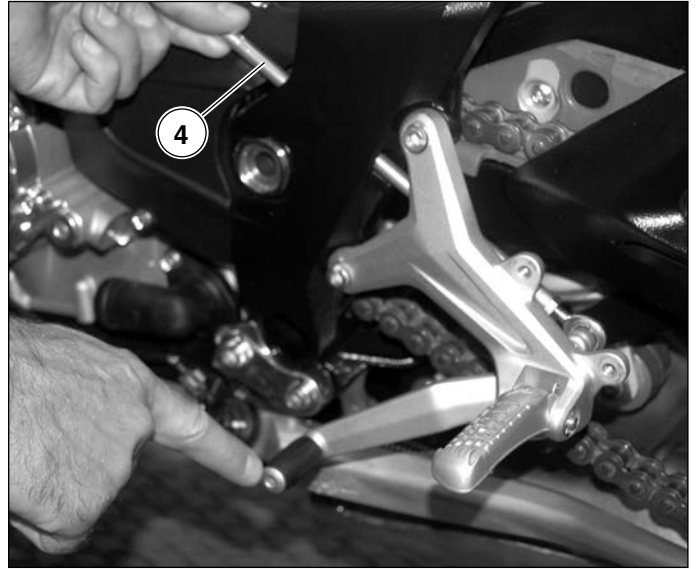

Adjustment of the gear change lever F3 ORO

The F3 ORO version, in addition to the adjustment of the version F3, also provides a 135° rotation for adjusting the pedal, achieved by rotating the screw **1** such as described for the rear brake lever.

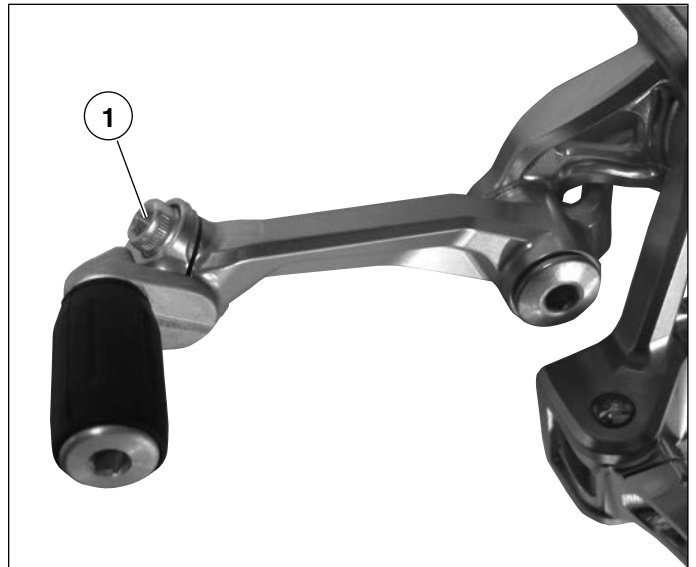

Footrest adjustment (F3 ORO)

In order to adjust the position of the rider's footrest, slacken the screw **(1)** by using a **16 mm** Allen wrench until the loss of contact between the toothed flanges of the footrest support.





Maintenance

Rotate the footrest support in the desired position. Apply the recommended thread-locking fluid on the threads of the screw (1). Tighten the screw at the prescribed torque pressure.



Thread-locking product used: Loctite 2400



Footrest support screw torque pressure: 40 N·m

NOTE Adjust both footrests to the same position.

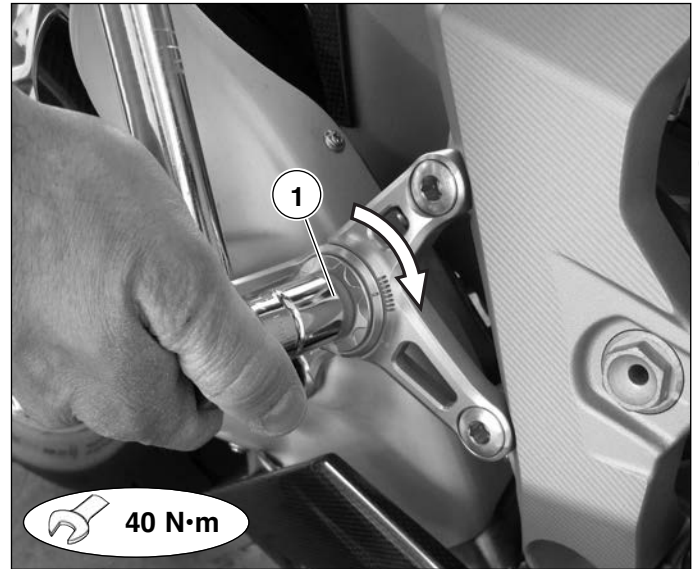

BRAKE PADS

Wear check / substitute → At the first 1000 kilometres and then every 6000 kilometres

Check the condition and thickness of the brake pads on the calipers.

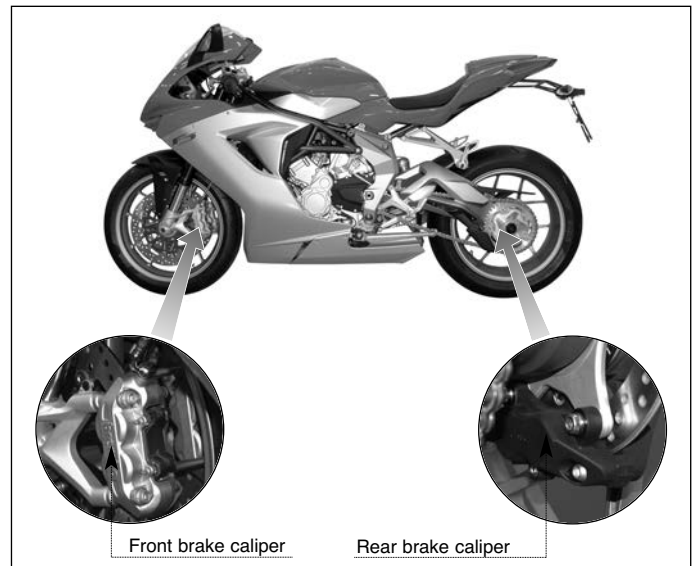

Measure the thickness of the pad linings. If the thickness of the linings is equal to or less than the wear limit shown below, replace the pads as described in chapter H "Brakes".

Wear limit: 1 mm.



If the brake pads are substituted, it is necessary to effectuate a proper running-in period before reaching an optimal braking efficiency.

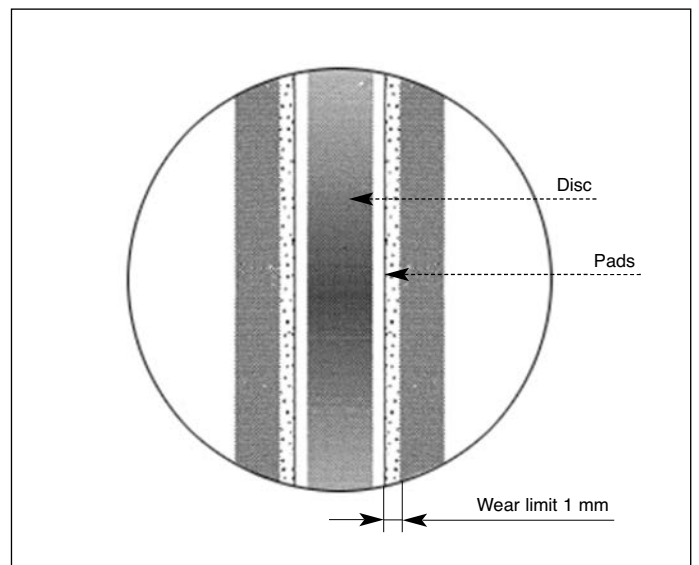



LOCKS

Check → At the pre-delivery, at the first 1000 kilometres and then every 6000 kilometres.

B Ignition/steering block switch

This switch has three operating positions.

 **Do not attach key rings or other objects to the ignition key that could obstruct the rotation of the steering.**

The ignition switch activates and disactivates the electrical system and the steering lock. The three control positions are as follows:

“OFF” position

All electrical circuits are disactivated. The key can be pulled out.

“ON” position

All electrical circuits are activated, the instruments and warning lights carry out self-diagnosis and the engine can be switched on. The key cannot be pulled out.

 **Do not attempt to change the functions of the ignition switch whilst the motorcycle is being ridden. It could cause the rider to lose control of the machine.**

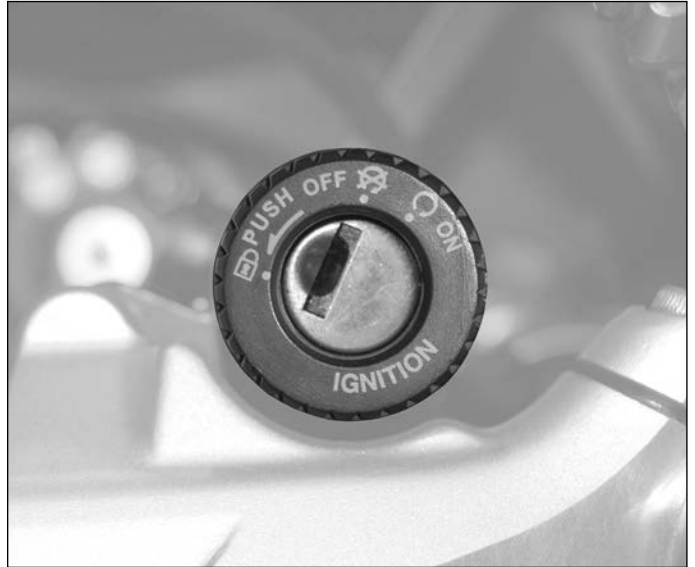

“OFF” position



“ON” position

“LOCK” position

Turn the handlebar left or right. Press the key down and rotate it to the “LOCK” position. All electrical circuits are disactivated and the steering is blocked. The key can be pulled out.

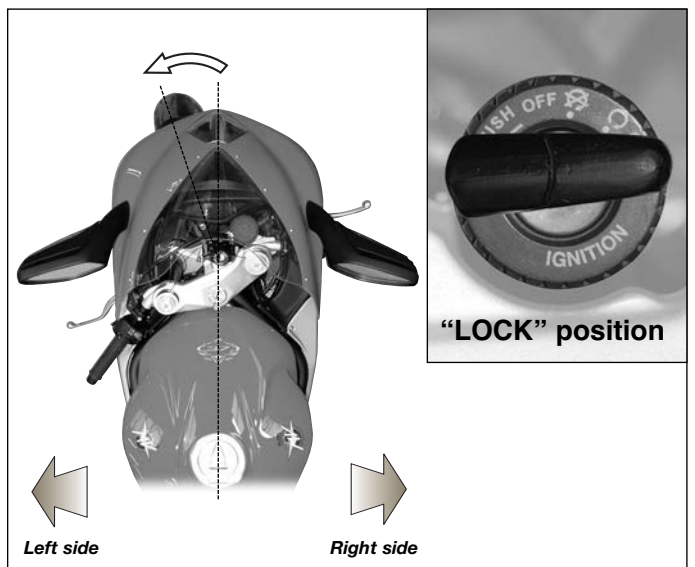

“LOCK” position



Fuel cap lock

Lift up the anti-dust cover.
Insert the key, rotating it in a clockwise direction and lift up the cap.



After refuelling, press the cap down and rotating the key contemporaneously to facilitate the closure. Let the key go free, bring it into a longitudinal position and pull it out.

If the fuel filler cap does not function (the cap does not close, the lock blocks, etc.) substitute it with a new one as described in chapter C "Bodywork".



Personal compartment lock

Insert the key.
Push the passenger seat downwards at the back and at the same time turn the key in a counterclockwise direction.
Lift up the passenger seat at the back end and rotate it as shown in figure.





Maintenance

In order to reassemble the above mentioned part, you must perform the following operations:

- Rotate the key into the lock
- Press down the passenger seat
- Release the key
- Press down the seat once more, so to make sure of its firm coupling to the frame.

If the seat lock is blocked, consult chapter C “Bodywork” for the substitution.





Maintenance

STEERING

Check and adjust → At the first 1000 kilometres and then every 12000 kilometres.

Check the steering components regularly according to the above-mentioned intervals.
If it is necessary to carry out adjustments, operate as described in chapter F “Suspension and wheels”.

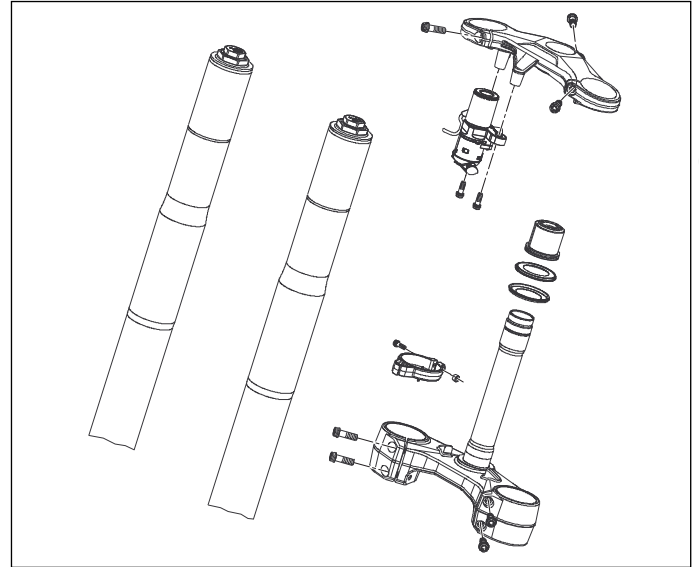

TRANSMISSION CHAIN

Check → At the pre-delivery, at the first 1000 kilometres and then every 6000 kilometres.

Substitute → Every 12000 km.

Place the motorcycle on the rear stand.
The chain tension check should be effectuated with the motorcycle having a static set-up quota equal to the standard value (see chapter F “Suspension and wheels”).

The axis of the chain lower portion must be **112 mm** from the lower chain guard.

Manually turn the rear wheel and perform the check at different points along the chain.

As the wheel is turned, the play should remain virtually the same. If, on the other hand, the play of the chain varies considerably, it means that some of the links are flattened, jammed or elongated.

Visually check the transmission chain for the following defects:

- Slack pins
- Damaged rollers
- Dry and rusty links
- Bent or seized links
- Excessive use
- Incorrect chain adjustment
- Damaged O-rings

The chain must be substituted if any one of these defects is found.

When substituting the transmission chain, substitute also the crown and pinion wheel.

For the substitution of the chain, pinion, crown wheel and to check the wear of the chain guide, follow the sequence described in chapter F “Suspension and wheels”.

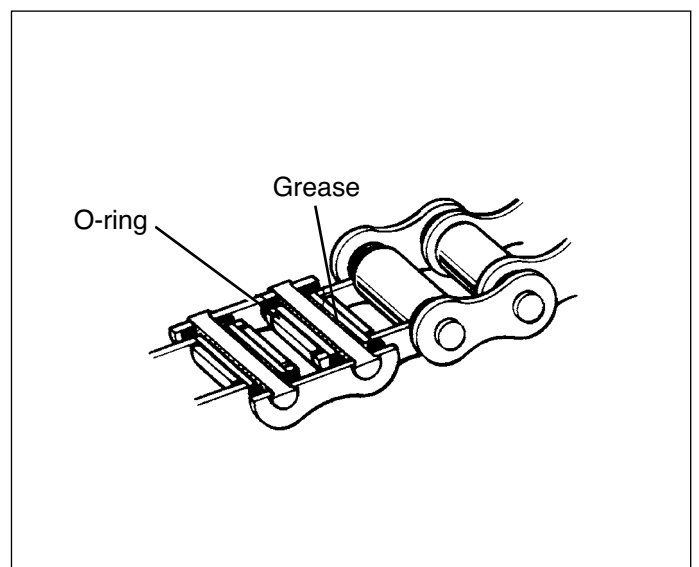
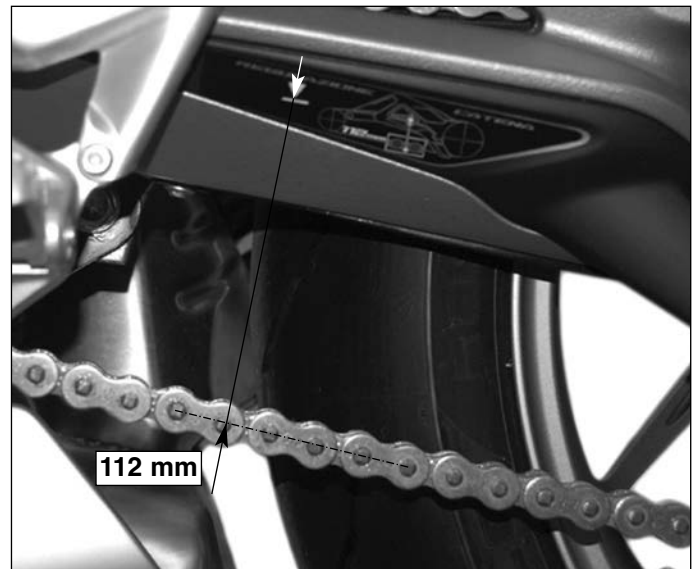



Maintenance

Regulation → At the first 1000 kilometres and then every 6000 kilometres.

To adjust the chain tension, proceed as follows:
Loosen the 2 rear wheel hub screws.



Using the special spanner as indicated in the figure, move the eccentric adjuster nut backwards or forwards respectively slackening or tightening the chain, until the correct play is reached (as described previously).

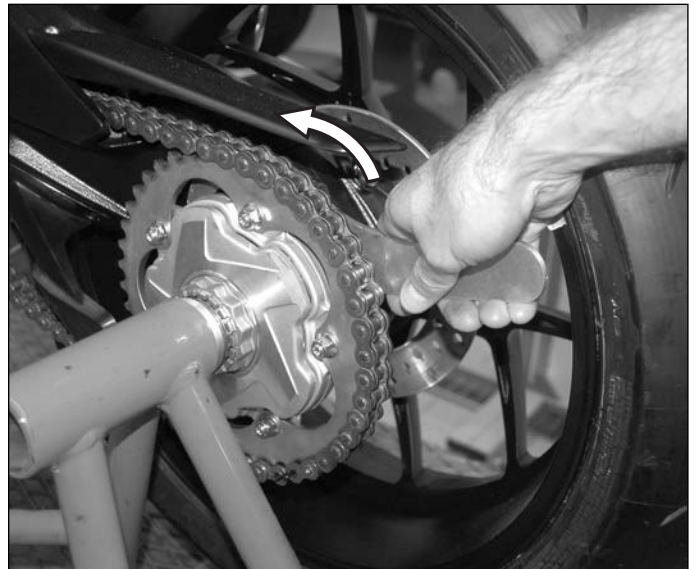

Successively tighten the screws of the rear wheel hub to the torque pressure indicated as follows:

NOTE Tighten the screws to the specified torque in several steps and in an alternate pattern.



Rear hub eccentric adjuster screw torque pressure: $28 \div 32$ N·m



Grease only the first threads.

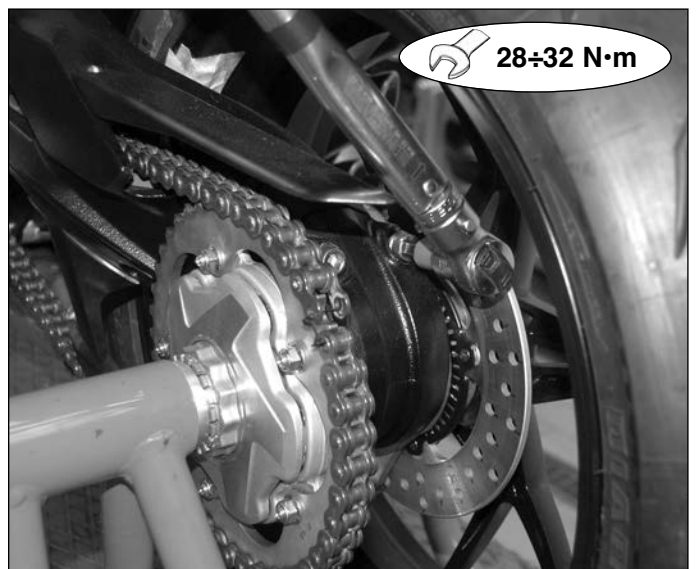



Maintenance

Chain lubrication

Lubricate → At the first 1000 kilometres and at 6000 kilometres and then at every 12000 kilometres.

The chain is of the O-ring type.
Clean the chain with a clean cloth and/or a jet of air.

Apply the lubricant after cleaning.



Utilise only the recommended lubricants or the equivalent (see page B-8).

Aim the spray at the inner link, so it will lubricate the surface of the O-rings and penetrate into the chain roll.

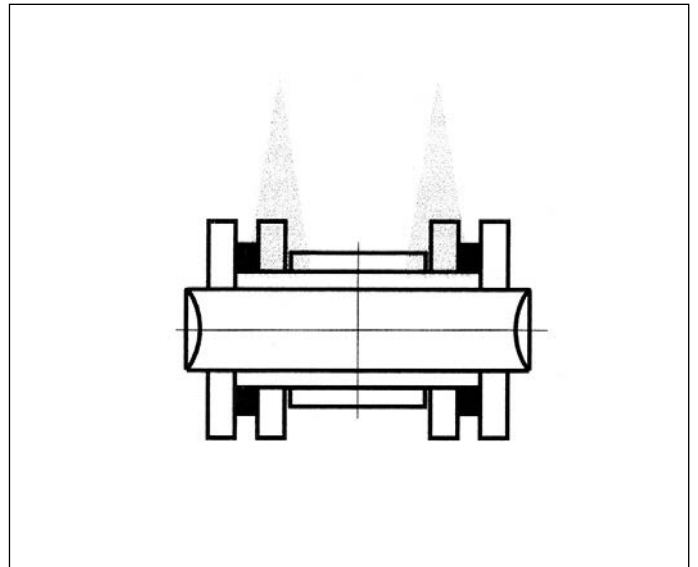
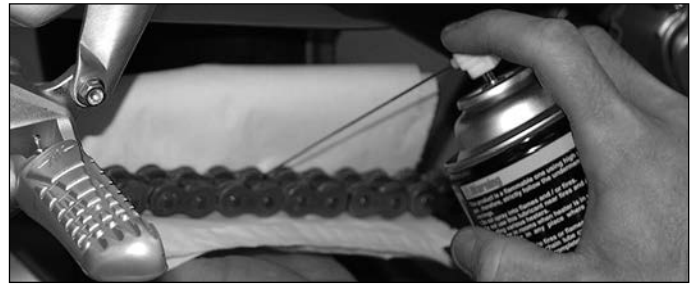

B



Maintenance

TYRES

Check pressures → At the pre-delivery, at the first 1000 kilometres and then every 6000 kilometres.

Check wear → At the first 1000 kilometres and then every 6000 kilometres.

If the tyre pressures are too high or too low, the ride is affected and tyre life duration is accentuated.

Therefore maintain the correct tyre pressures to obtain better roadholding and the maximum wear from the tyres. The cold tyre pressures are indicated in the table.

Tyre pressures

Brand and type	PIRELLI - Diablo Rosso Corsa
Front	2,3 bar (33 psi)
Rear	2,3 bar (33 psi)



The use of the motorcycle with excessively worn tyres diminishes the roadholding and is therefore dangerous. It is highly recommended to change the tyres when the tyre tread reaches a minimum of 1.5 mm.



Ride with extreme care during the initial kilometres after replacing the tyres.

Utilise exclusively the tyres recommended.

Tyre tread minimum limit = 1.5 mm

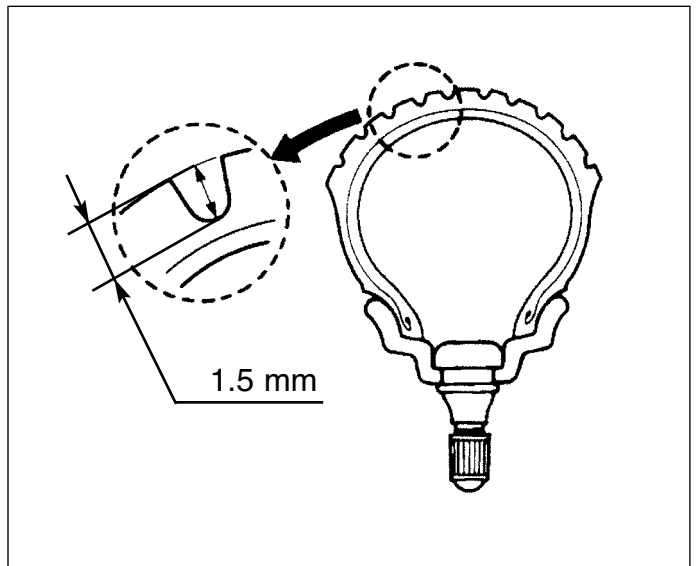

FRONT WHEEL BEARINGS

Check → Every 6000 kilometres and at every tyre change.

Substitute → Every 36000 kilometres.

If excessive play of the front wheel bearings is found during checks, then substitute them as indicated in chapter F "Suspension and wheels".

WHEELS

Visual check → At the first 1000 kilometres and then every 6000 kilometres (at least every tyre change).

After having visually checked or following even light collision damage, it is necessary to check the planarity, the eccentricity and the ovalisation of the wheel. See the control procedures described in chapter F “Suspension and wheels”.

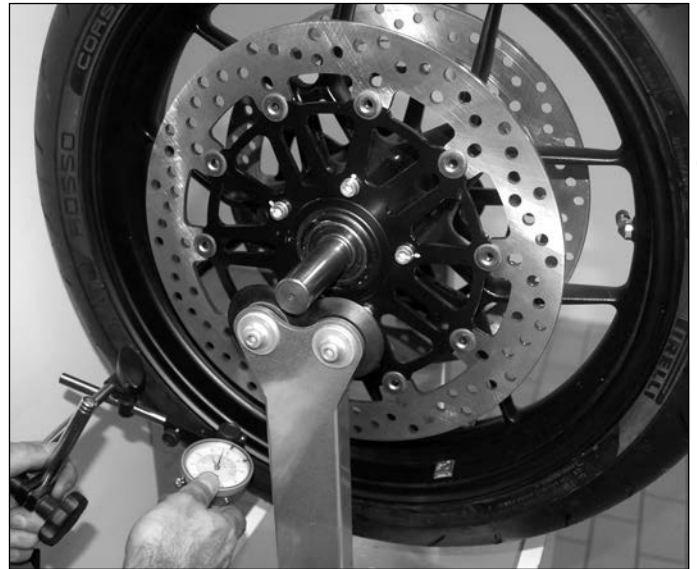

B

REAR WHEEL HUB

Check and lubricate bearings → Every 12000 kilometres
Substitute → Every 36000 kilometres

To check and overhaul the rear wheel hub unit, it is necessary to carry out certain preliminary operations by consulting the relative chapters.

Remove the rear wheel (see chapter F “Suspension and wheels”). Lift up the motorcycle by utilising a mechanic’s lift. Remove the Seeger ring of the crown wheel fixing nut (see chapter F “Suspension and wheels”). Slacken the fixing nut of the wheel axis (see chapter F “Suspension and wheels”).

Remove the brake caliper (see chapter H “Brakes”). Check and overhaul the rear wheel hub unit (see chapter F “Suspension and wheels”).

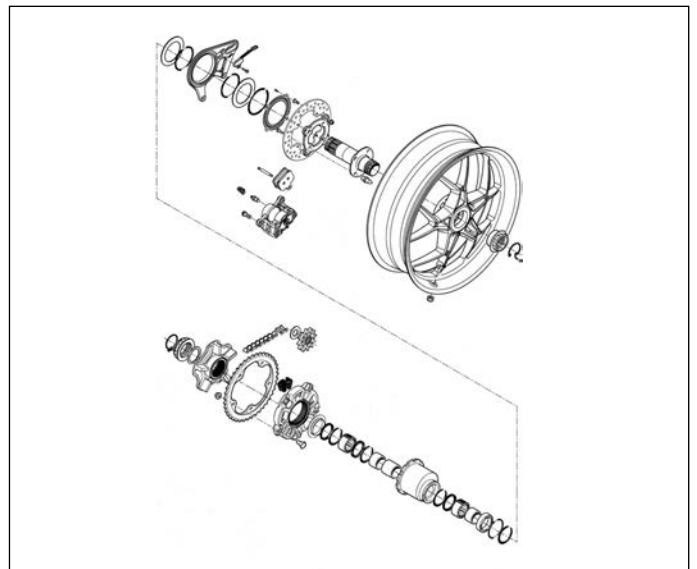

SWINGARM BEARINGS

Check and lubricate → Every 36000 kilometres

If excessive play is found on the swingarm, due to the bearings assembled on the central pin of the swingarm/frame, substitute them as described in chapter F “Suspension and wheels”.

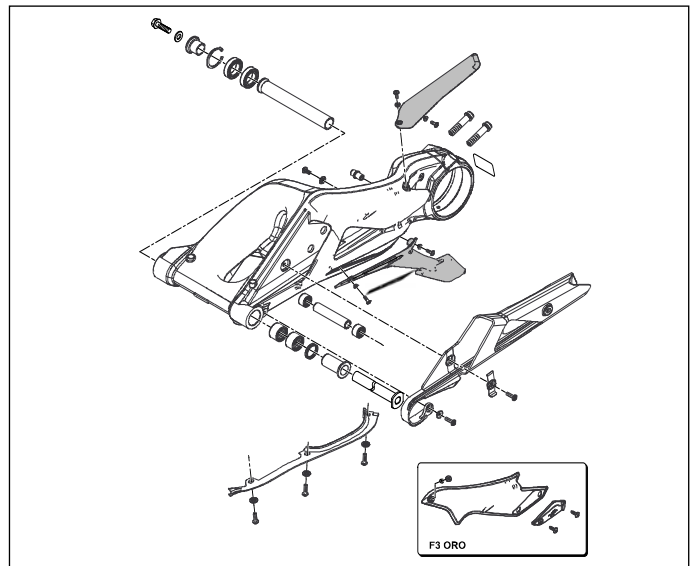



REAR SHOCK ABSORBER

Check and adjust → At the first 1000 kilometres and then every 12000 kilometres.

B

Carry out a check on the length of the rear shock absorber spring; check for leakages and trickles of oil and also check the adjustment function.

Spring adjustment standard A:

- F3 675: A = 161,5 mm
- F3 ORO: A = 142 mm



The shock absorber contains gas under high pressure. Do not touch the shock absorber valve. Do not attempt in any way to remove the shock absorber.

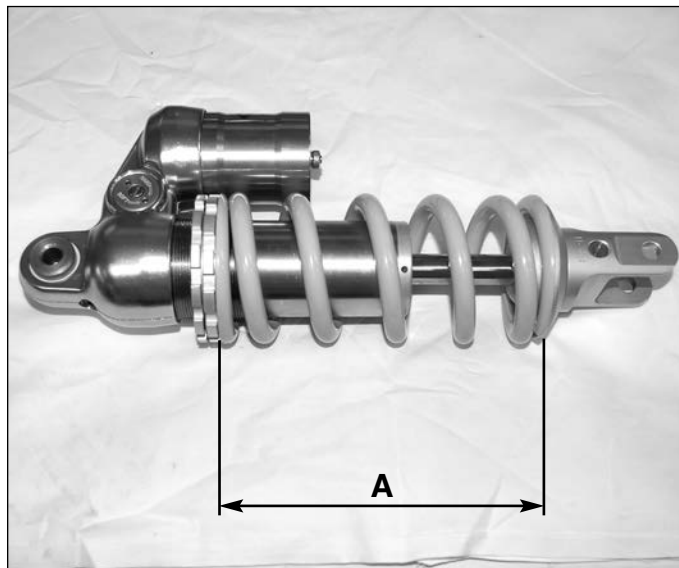

Extension and compression adjustments (rear suspension):

(See adjustments Table - chapter "F - SUSPENSION AND WHEELS" - page 48).



The adjustments can be performed with the rear shock absorber fitted on the vehicle. To conduct further checks on the ball joints of the rear shock absorber links, follow the removal procedure described in chapter F "Suspensions and Wheels".

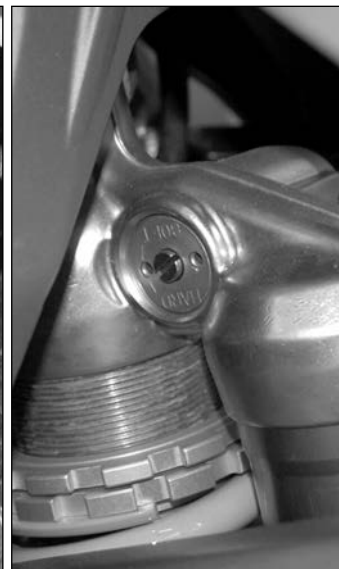



SIDE STAND

Functional check → At the pre-delivery, first 1000 kilometres and then every 6000 kilometres.

Make sure the bike cannot be started when the stand is down and the bike is in gear. Also check that with the engine switched on, when the side stand is lowered and a gear is engaged, the engine switches off automatically.

If not, the cause could be a faulty switch mounted on the side stand. If this is the case, substitute the switch by carrying out the following procedure.

Disconnect the electrical connectors (1).
Remove the screw on the side stand (2).
Remove the switch.
After having substituted the switch, tighten the screw to the prescribed torque.

 **Torque pressure: 8 ÷ 10 N·m**

 **Apply Loctite Media 243**

Reconnect the electrical connector.

Check that the side stand is not worn.

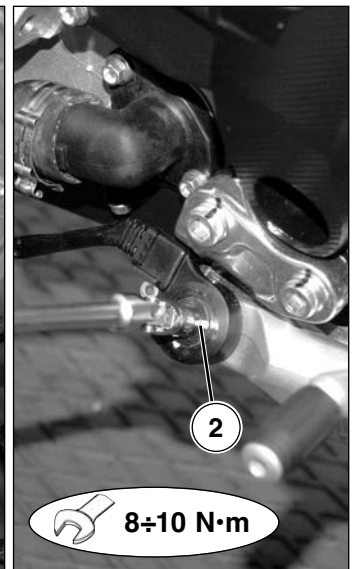
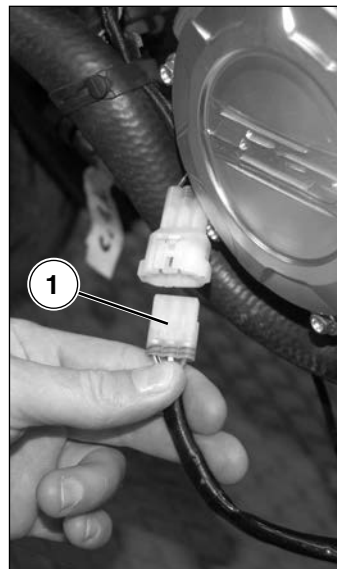
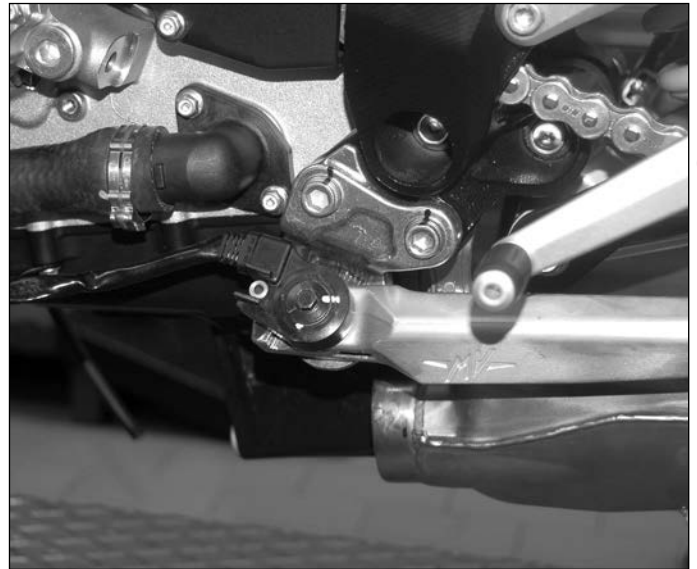

To remove the stand, follow these steps:

- remove the sidestand switch and release the two springs (3);
- remove the nut located behind the stand mount (4);
- remove screw (5).

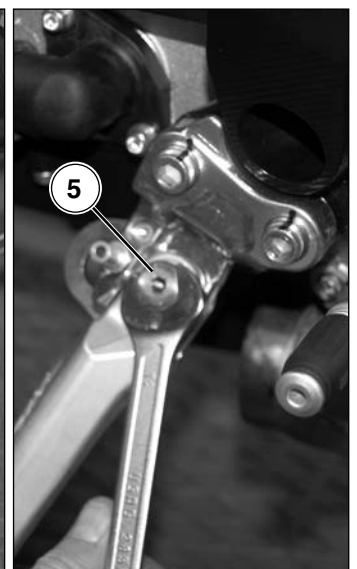
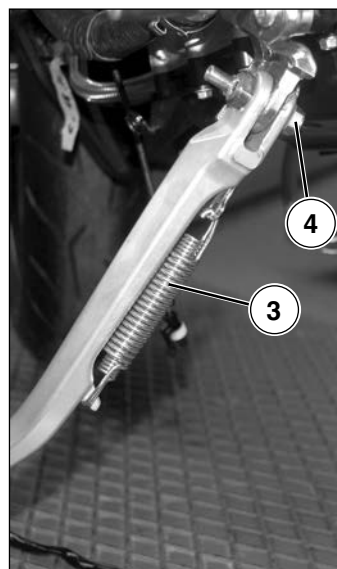



Maintenance

In case you should have to replace the bracket plate, remove the two fixing screws (6).

To refit the stand, follow the same steps in reverse order, taking care to tighten the nut to the prescribed torque.



Tightening torque for stand plate screws (6):
 $40 \div 44 \text{ N}\cdot\text{m}$



Apply Loctite Media 243



The substitution of the springs must be carried out utilising the appropriate tool. Before reattaching the springs, ensure that the stand can swing freely (with no friction or sticking).

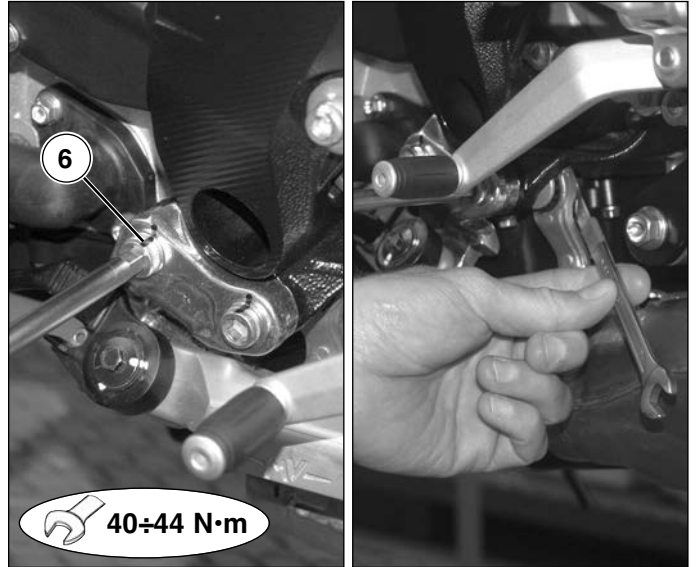

FRONT FORK

Substitute oil → every 24000 kilometres

The front fork is vitally important for the handling and stability of the motorcycle. It is therefore necessary to substitute the fork oil at the prescribed intervals.

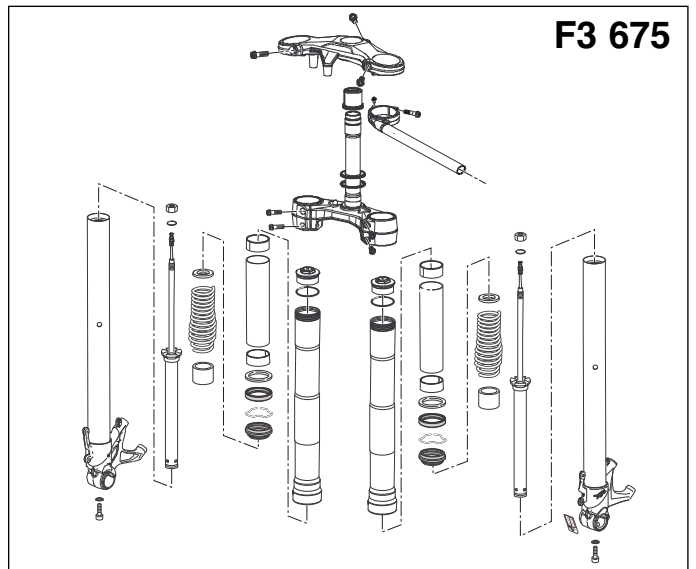

To substitute the fork oil and to do a complete overhaul of the forks, carry out the described operations in chapter F "Suspension and wheels".

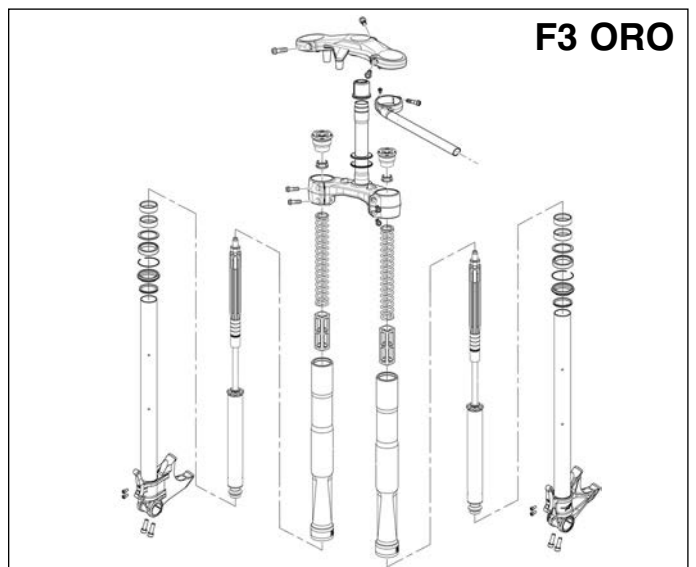



Maintenance

SCREWS AND NUTS

Check and tighten → At the pre-delivery, at the first 1000 kilometres and then every 6000 kilometres. Carry out an accurate check of the tightness of the nuts and screws on the motorcycle at the intervals prescribed. Consult the table in chapter N "Torque pressures" for the correct values.

TUBE BAND FASTENERS

Check and tighten → At the pre-delivery, at the first 1000 kilometres and then every 6000 kilometres. Carry out a general check on all tube band fasteners for their condition and tightness. Substitute damaged band fasteners by following the relative procedure delineated in the various sections.

ELECTRICAL SYSTEM

Check the functioning → At the pre-delivery, at the first 1000 kilometres and then every 6000 kilometres. Carry out a detailed check on the various parts of the electrical system, the contacts between components and their good functioning. Consult chapter E "Electrical system" for these checks.

BATTERY

Check and clean connections → At the first 1000 kilometres and then every 6000 kilometres. Consult chapter E "Electrical system" for the check on the battery condition. If it is necessary to disconnect the battery and remove it during overhauls carried out on the motorcycle, follow the procedure in chapter E "Electrical system".

INSTRUMENTS AND WARNING LIGHTS

Check → At the pre-delivery, at the first 1000 kilometres and then every 6000 kilometres.

The instrumentation check must be carried out completely on all its functions as listed in the following list. If even one of the functions does not function correctly, consult chapter E "Electrical system" for complete details.

Turning the ignition key to the "ON" position activates the instruments and the warning lights. After an initial check-up (approximately seven seconds) the information received correspond to the general condition of the motorcycle at that moment.

Warning lights

- 1 RPM limiter indicators (orange/red)**
They switch on before the limiter intervention, at a number of turns dependent on the ratio of the inserted gear. The limiter intervenes at 15000 rpm.
- 2 Reserve fuel indicator (orange)**
Comes on when approximately 4 litres of fuel are left.
- 3 Neutral warning lights (green)**
It turns on when the gear is in "Neutral".
- 4 Turn indicator light (green)**
Lights up when the turn indicators are activated.
- 5 Headlights (blue)**
It turns on when the headlights are on.
- 6 Engine oil pressure warning lights (red)**
Lights up when the oil pressure is insufficient.



WARNING

If the warning light comes on while riding, stop the motorcycle immediately. Check the oil level and if necessary, top up.

- 7 Battery charge indicator (red)**
Lights up when the alternator does not supply enough current to charge the battery.

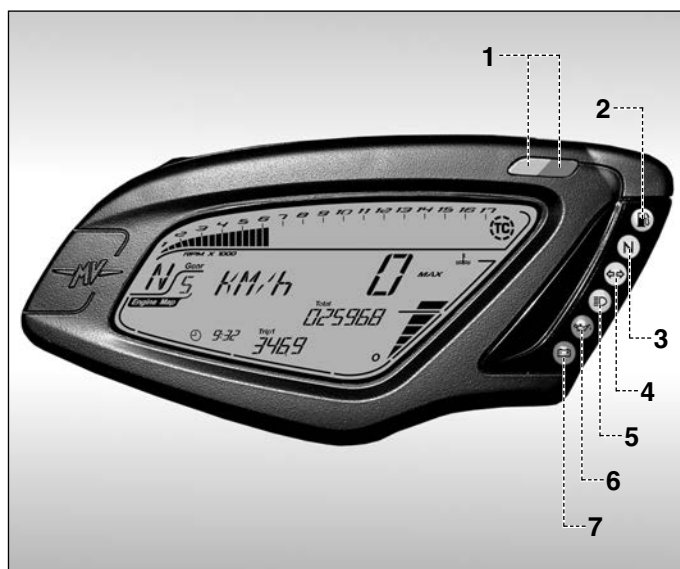
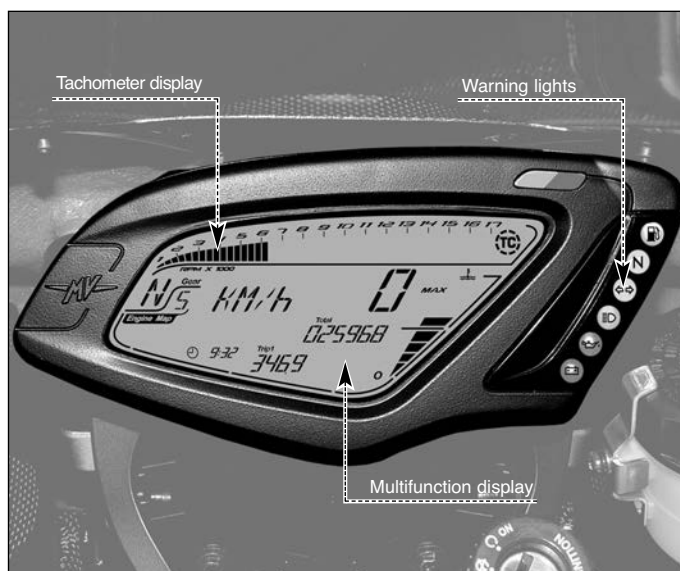



Multifunction display

10 Gear display

It displays the currently engaged gear. "N" stands for "neutral".

11 Control unit mapping display

Indicates the number of the control unit mapping currently selected.

12 Speedometer

It displays the speed of the motorbike. It can be given in kilometres per hour (Km/h) or in miles per hour (Mph). The full scale measures 300Km/h (186 Mph).

13 Thermometer

It displays the temperature of the coolant by turning on a variable number of segments on a graduated scale. When the temperature falls outside the normal operating range, it may display one of the following information:

- the display shows just one blinking segment; it means that the temperature is low;
- all segments are on, while the upper segment is blinking; it means that the temperature is high.



Danger - Notice: if the temperature is high, stop the motorbike and check the coolant level. In the event that it was necessary, top up. If the warning light turns on even if the level is adequate, stop driving.

14 Traction control level display

Indicates the traction control level currently selected.

15 "TOTAL" odometer:

It displays the total distance covered; from 0 to 999999 (Km or miles)

Trip counter 1, "TRIP 1"

It displays the length of a trip; from 0 to 999.9 (Km or miles)

Trip counter 2, "TRIP 2"

It displays the length of a trip; from 0 to 999.9 (Km or miles)

Chronometer

It displays the time measured by the chronometer.

16 Clock

Indicates the current time.

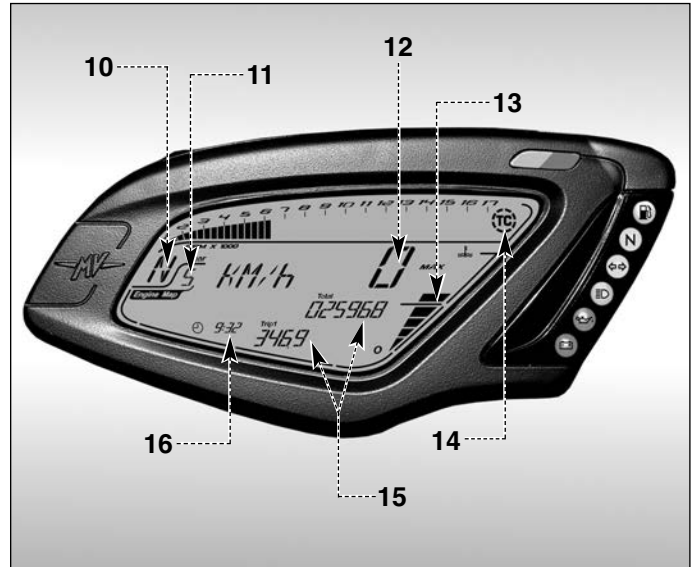



Maintenance

Selecting and setting the display functions

Some of the main measurements of the instruments may be changed.

The available options include:

- Select an operating mode:

- “RUN” (Odometer)
- “SPEED LIMITER”
- “TC” (Traction control)
- “CHRONO” (Chronometer)
- “QUICK SHIFT” *
- “CLOCK” (Clock)

- Reset the trip counter:

- | | |
|----------------|----------|
| Trip counter 1 | “TRIP 1” |
| Trip counter 2 | “TRIP 2” |

- Turn on the chronometer

- Clock settings

- Control unit mapping selection

Selecting the display functions

The following settings may be changed on the display:

- “RUN” (Odometer)
- “SPEED LIMITER”
- “TC” (Traction control)
- “CHRONO” (Chronometer)
- “QUICK SHIFT” *
- “CLOCK” (Clock)

To display the operating modes, press “SET” for less than three seconds. When pressed, the display shows all modes, in a sequence. Select the desired mode.



WARNING

The operation must be performed while the engine is not running, the gears are in neutral, the motorcycle is stationary, and with the feet on the ground. Do not set the display functions while riding, except where otherwise indicated.



(*): This function is present only on certain models; available in aftermarket on all models



Maintenance

“RUN” mode

In addition to the speedometer, the display shows the following functions:

- Total odometer “TOTAL”
- Trip counter 1 “TRIP 1”

As an alternative:

- Total odometer “TOTAL”
- Trip counter 2 “TRIP 2”



“SPEED LIMITER” mode

This mode adjusts the maximum value of the vehicle speed to your driving requirements.



“TC” Mode

This Mode adjusts the engine traction control level to your driving requirements.





Maintenance

“CHRONO” Mode

This mode turns on the Chronometer and saves the recorded information. The following is displayed:

- Chronometer Current lap “CURRENT LAP”
- Chronometer Fastest lap “BEST LAP”
- Chronometer Last lap “LAST LAP”
- Rev counter Total laps covered “N° LAP”



“QUICK SHIFT” mode *

This mode allows to turn off or on the “quick shift” function of the gear change.



(): This function is present only on certain models;
available in aftermarket on all models*

“CLOCK” Mode

The present function enables to change the time (hours and minutes) reported on the dashboard.

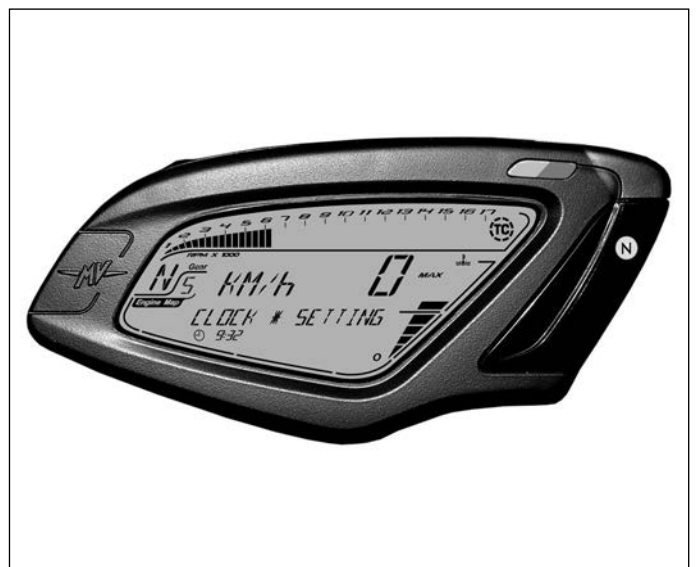



Maintenance

Trip reset

To reset "TRIP 1" and "TRIP 2", proceed as follows.



WARNING

The display modes may be changed or set when the engine is off, the gear in neutral, the motorbike stationary with your feet on the ground. The display may not be changed while driving.



- Access the "RUN" mode; the total speedometer ("TOTAL") and partial speedometer 1 ("TRIP 1") will appear on the display.
- By pressing the "OK" key for more than three seconds, the "TRIP 1" value will be reset to zero.

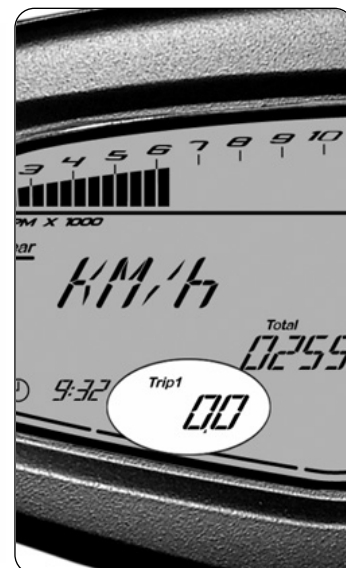

- Press the "OK" key for less than three seconds until the partial speedometer 2 function ("TRIP 2") appears on the display.

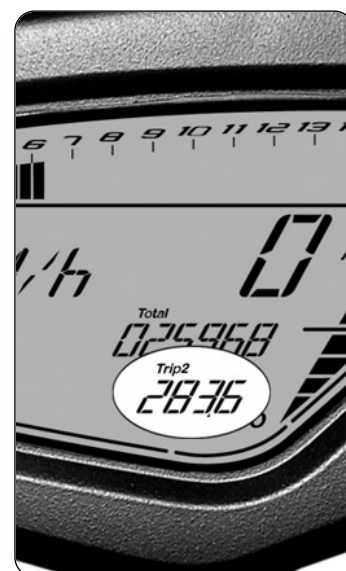



Maintenance

- By pressing the “OK” key for more than three seconds, the “TRIP 2” value will be reset to zero.

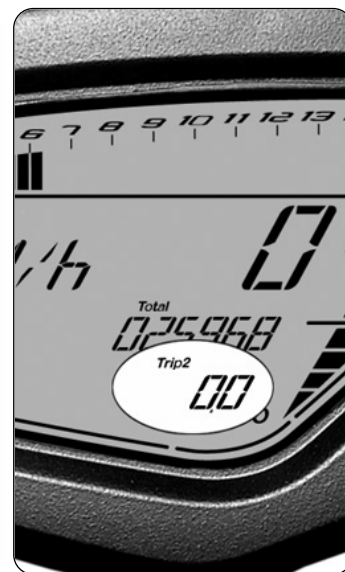

“SPEED LIMITER” mode

When starting the engine, the “SPEED LIMITER” function is disabled. In order to activate it, it is necessary to perform the following operations:

- Press “SET” in order to access to “SPEED LIMITER” mode. The maximum speed value shown on the display (equal to the current speed of the vehicle) starts blinking.

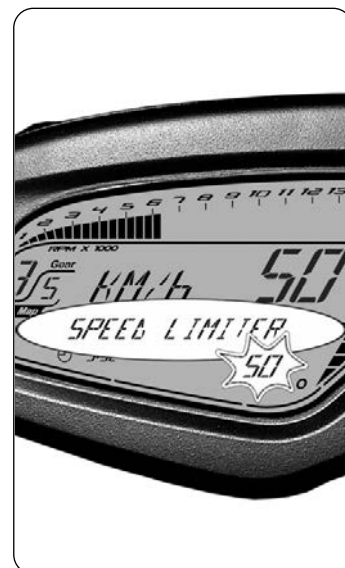

NOTE: The maximum speed may be changed or set even during the use of the vehicle.

- Press “SET” for less than three seconds: the maximum speed value is decreased of **2 km/h** with reference to the one shown on the display. On the other hand, if you press “OK” for less than three seconds, the maximum speed value is increased of **2 km/h** with reference to the one shown on the display.





Maintenance

- Press “OK” for over three seconds to confirm the selected maximum speed value. The displayed digit stops blinking and the display returns to “RUN” mode.

B - On the other hand, if you press “SET” for over three seconds, the “SPEED LIMITER” function is disabled. The display shows the “OFF” caption. After three seconds, the display returns to “RUN” mode.

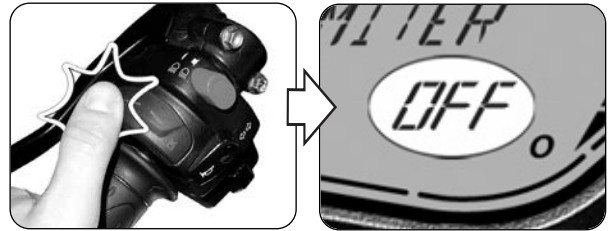
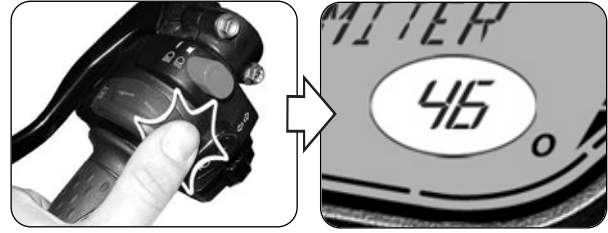

- If the “SPEED LIMITER” function has been enabled, when riding the vehicle the speed value shown on the odometer starts blinking when it reaches the set value of the maximum speed.



“TC” Mode

- Press “SET” in order to access to “TC” mode, then press “OK” for less than three seconds until “TC LEVEL” appears. The current traction control level is the same as the one shown on the display.

NOTE

The traction control level may be changed or set even during the use of the vehicle.

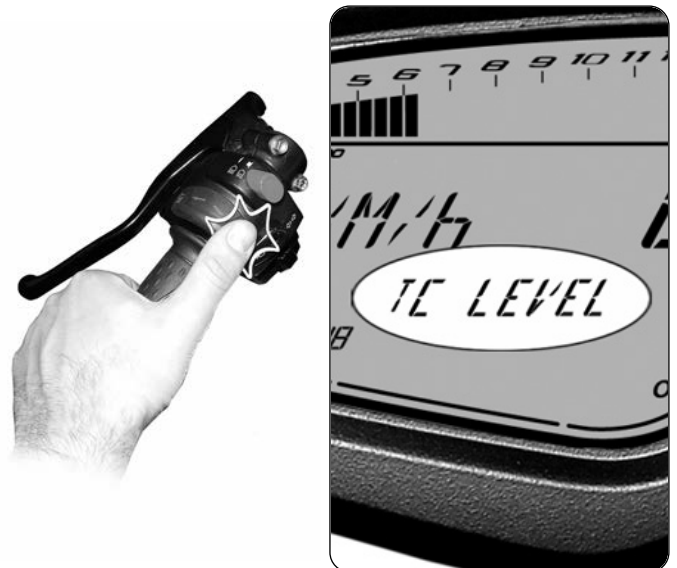



Maintenance

- Press “OK” for less than three seconds: the traction control level rises up to the next value. On the other hand, by pressing “SET” for less than three seconds, the traction control level decreases to the lower value. Such value may range between **0** and **8**.
- Press “SET” for over three seconds to confirm the selected traction control level.

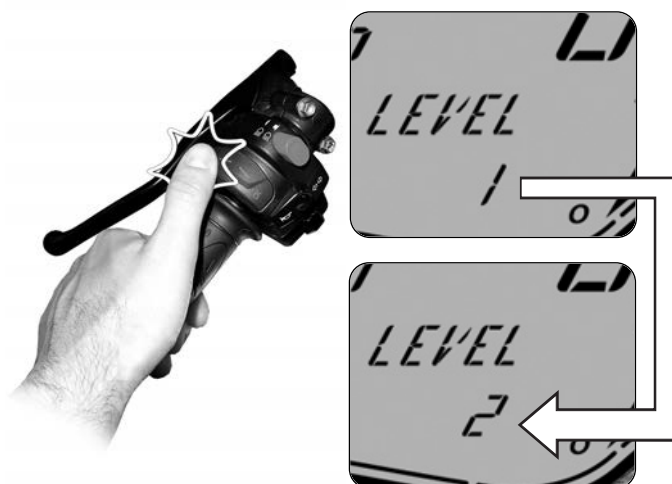

Chronometer

Lap time recording

- Turn on the chronometer (“CHRONO” mode) to record the time taken to cover a lap.



- Press the headlight button to start recording the time. The colon that separates the minutes from the seconds and from the tenths of a second will start blinking. Now, the instrument is recording the time.

NOTE: When the “CHRONO” mode is activated, the first pressing of the headlight button automatically enables the “TC” function. From this moment on, it is possible to immediately change the traction control level by properly operate the “SET” and “OK” buttons.





Maintenance

- Press the headlight button again to record the time taken to cover the 1st lap. At the same time, the instrument starts recording the time taken to cover the second lap.

B The time measurement for the first lap is stored in the memory and is visualised on the display for ten seconds, after which the time measurement for the following lap appears.



- If using the chronometer again, every time you press the headlight button, it records a time. The instrument can record up to 100 consecutive times.

When the time for the lap which has just concluded is displayed, the symbol “+” or “-” appears if the time recorded is respectively higher or lower than the time measured during the previous lap.



Data display

Once all times have been recorded, they may be displayed.

- Access the “CHRONO” mode; the time of the fastest lap (“BEST LAP”) and the time of the last lap (“LAST LAP”) appears on the display.



WARNING

The display modes may be changed or set when the engine is off, the gear must be in neutral, the motorbike must be stationary with your feet on the ground. Do not change the display while driving.

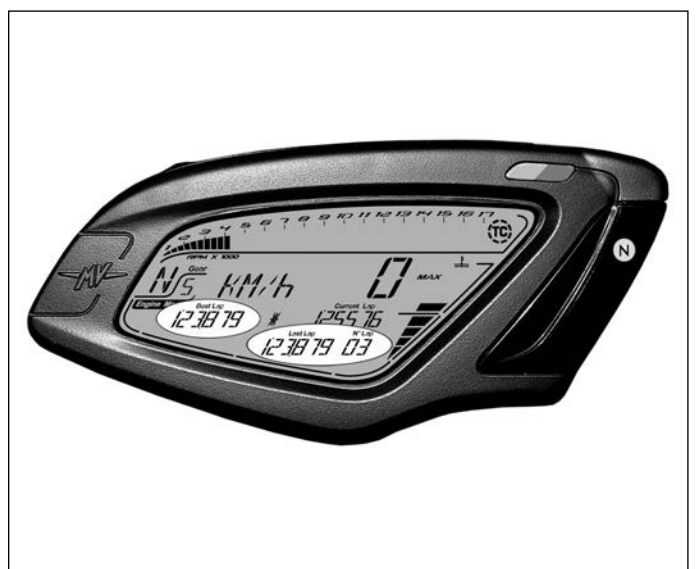



Maintenance

- Press “OK” for less than three seconds until “LAPS VIEW” appears.



- By repeatedly pressing the key of the flashing high beam headlight, all the times previously acquired starting from the last lap memorised can be displayed in sequence.



- Once all the data have been displayed, press the “SET” key to return to the “LAPS VIEW” mode and then to the following mode.



How to delete data

To delete the saved data, proceed as follows:

B



WARNING

The display modes may be changed or set when the engine is off, the gear in neutral, the motorbike stationary with your feet on the ground. Do not change the display while driving.

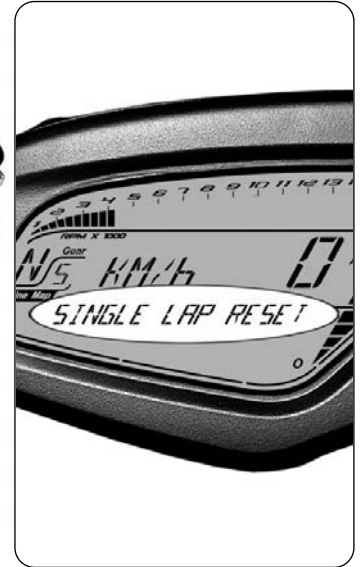

- *Resetting of individual time recordings:* Access the "CHRONO" mode and press the "SET" key for less than three seconds until the words "SINGLE LAP RESET" appear on the display.

- Press the "OK" key for less than three seconds; the value of the last lap time memorised will start flashing.

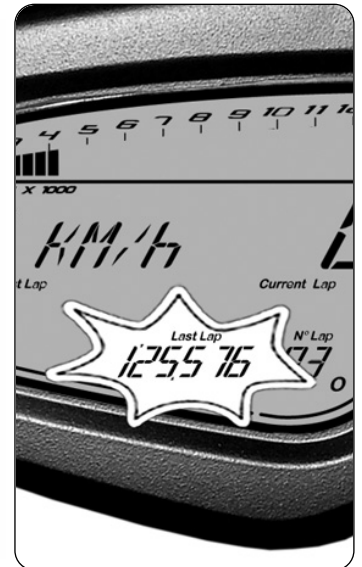

- Now, press "OK" for over three seconds to delete the value. Otherwise, press "SET" for less than three seconds to stop the deletion procedure.

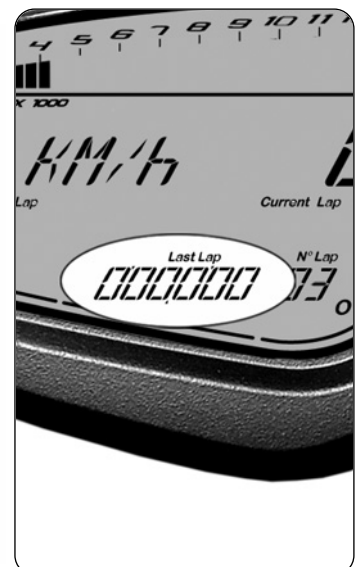



Maintenance

- Subsequently, by pressing the flashing high beam headlight key followed by the “OK” key for more than three seconds, all the previously acquired times can be cancelled.
- Once all the data have been cancelled, press the “SET” key to return to the “SINGLE LAP RESET” mode and then to the following mode.

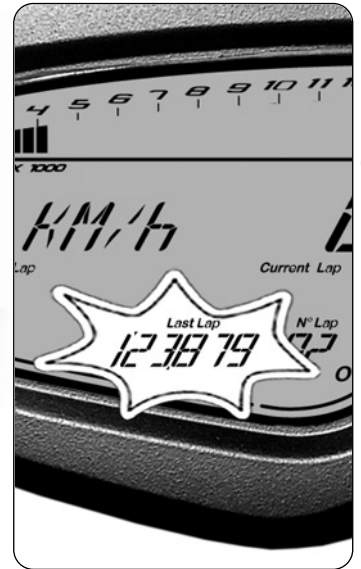

- *Resetting of best lap time:* Access the “CHRONO” mode and press the “SET” key for less than three seconds until the words “BEST LAP RESET” appear on the display.



- Press the “OK” key for less than three seconds; the value of the fastest last lap time memorised will start flashing.





Maintenance

- Now, press “OK” for over three seconds to delete the value. Otherwise, press “SET” for less than three seconds to stop the deletion procedure.

B - Once all the data have been cancelled, press the “SET” key to exit the “BEST LAP RESET” mode and then pass to the following mode.

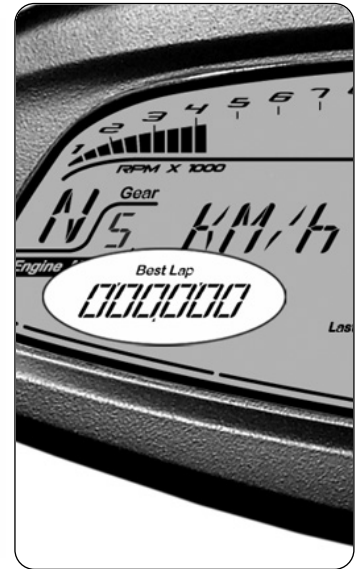

- *Resetting of all lap times recorded:* Access the “CHRONO” mode and press the “SET” key for less than three seconds until the words “ALL LAPS RESET” appear on the display.



- Press the “OK” key for less than three seconds; the display will ask you to confirm cancellation of all the data present in the memory.



- By pressing the "OK" key for more than three seconds, all the previously acquired times will be cancelled. By pressing the "SET" key for less than three seconds, the cancellation procedure will be interrupted.

- Once all the data have been cancelled, press the "SET" key to exit the "ALL LAPS RESET" mode and to return to the "CHRONO" mode.

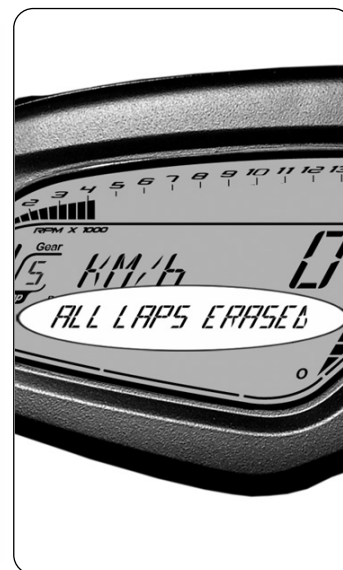

"QUICK SHIFT" mode *

- Press "SET" in order to access to "QUICK SHIFT" mode. The display shows the current activation state of the "quick shift" function of the gear change ("ON": activated; "OFF": not activated).



WARNING

The display modes may be changed or set when the engine is off, the gear in neutral, the motorbike stationary with your feet on the ground. Do not change the display while driving.

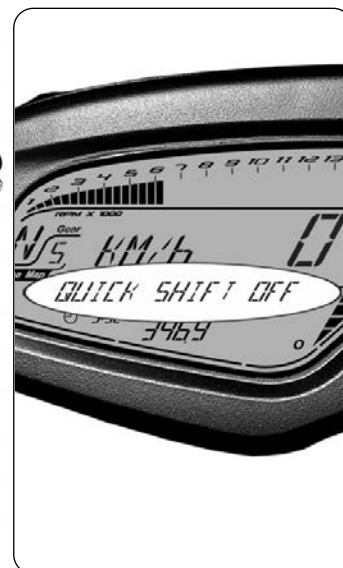

- Press the "OK" button for less than three seconds; the activation caption of the "quick shift" function begins to flash.

- By pressing the "OK" button for less than three seconds, the caption toggles from "OFF" to "ON" and inversely.

- Press "SET" to confirm the selected "quick shift" activation state.

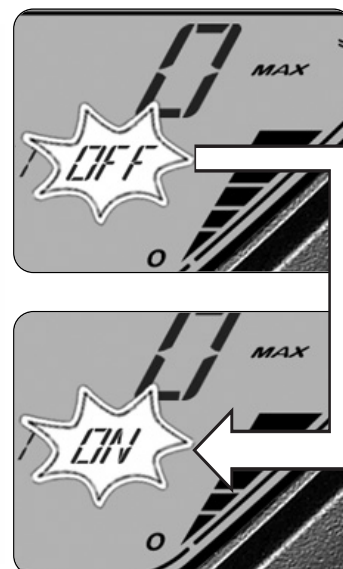

(*): This function is present only on certain models; available in aftermarket on all models

Clock settings

- To carry out clock settings, press the "SET" button until viewing the "CLOCK SETTING" caption.



WARNING

The display modes may be changed or set when the engine is off, the gear in neutral, the motorbike stationary with your feet on the ground. Do not change the display while driving.

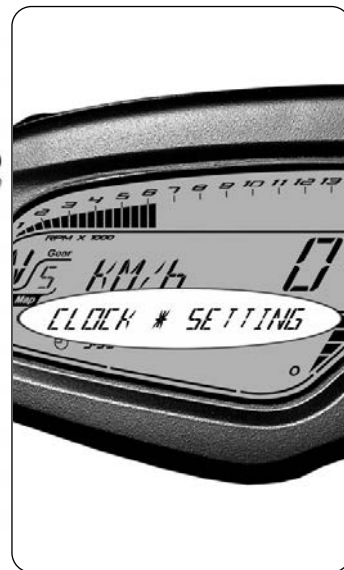

- Press the "OK" button for less than three seconds; the hour digit begins to flash.

- By pressing the "OK" button again for less than three seconds, the hour digit is increased by going to the following numeric value.

- Press the "OK" button for over three seconds; the selected hour digit is confirmed. If instead one presses the "SET" button for less than three seconds the setting procedure is interrupted.

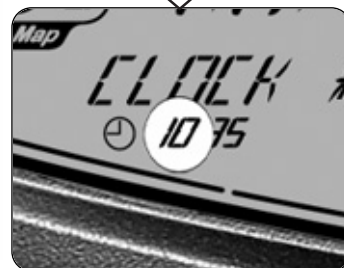

- After having carried out the hour digit setting, the dashboard automatically switches to the minute digit setting. The minute digit begins to flash.

- By pressing the "OK" button for less than three seconds, the minute digit is increased by going to the following numeric value.

- Press the "OK" button for over three seconds; the selected minute digit is confirmed and the dashboard returns to "CLOCK" mode. If instead one presses the "SET" button for less than three seconds the setting procedure is interrupted.





Maintenance

How to select the mapping of the control unit

On the F3 model is it possible to select different control unit mappings which allow to obtain variable power and performance characteristics based on the type of vehicle use.

NOTE

The mapping selection may be performed even during the use of the vehicle.

The mapping of the control unit can be selected by pressing the start button when the engine is switched on; this way the mapping switches to the following setting value. The corresponding mapping characteristics are listed in the following table.

Mapping	N	R	S	C
Mode	Normal	Rain	Sport	Customised

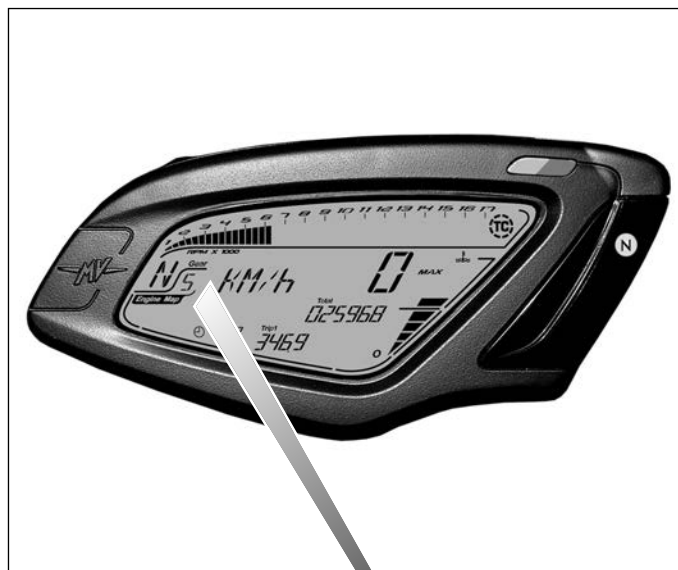

B

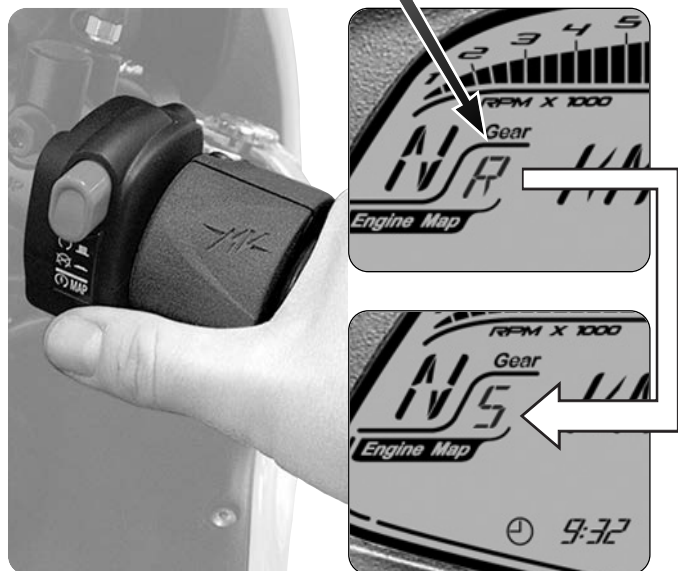

Setting of "Custom" mapping

- Press the start button when the engine is switched on until selecting the mapping "C" of the control unit ("Custom" mapping).



WARNING

The "Custom" mapping setting operations must be performed when the gear is in neutral and the motorbike stationary with your feet on the ground. Do not change the display while driving.

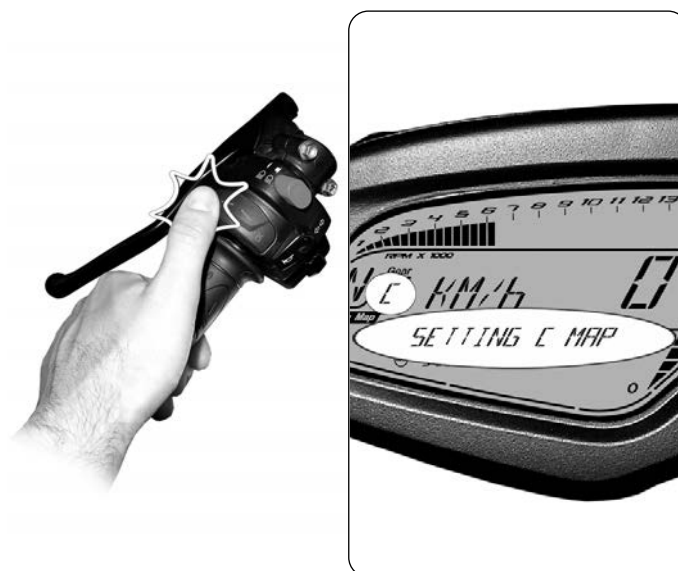



Maintenance

- Press "SET" until "SETTING C MAP" appears.

In order to adjust the "Custom" mapping parameters to your driving requirements, perform the following operations.

- *Throttle control sensitivity:* Press "OK" for less than three seconds until "GAS SENSITIVITY" appears.



- Press "SET" for less than three seconds. The display shows the current setting for throttle control sensitivity.



- Press "OK" for less than three seconds; the displayed setting will start flashing.

- By repeatedly pressing "OK" for less than three seconds, the following settings can be displayed in sequence:

- "NORMAL"
- "RAIN"
- "SPORT"





Maintenance

- Press "OK" for more than three seconds; the new setting will be confirmed. The displayed caption stops flashing and after a few seconds the display returns to "GAS SENSITIVITY" mode. It is now possible to proceed with the setting of the following parameter.

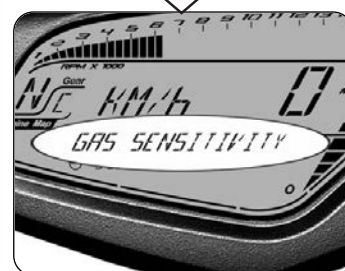

- *Maximum engine torque*: Press "OK" for less than three seconds until "MAX ENGINE TORQUE" appears.

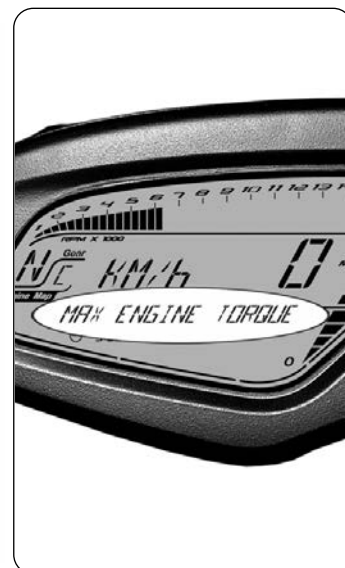

- Press "SET" for less than three seconds. The display shows the current setting for maximum engine torque.





Maintenance

- Press "OK" for less than three seconds; the displayed setting will start flashing.

- By repeatedly pressing "OK" for less than three seconds, the following settings can be displayed in sequence:

- "RAIN"
- "SPORT"



- Press "OK" for more than three seconds; the new setting will be confirmed. The displayed caption stops flashing and after a few seconds the display returns to "MAX ENGINE TORQUE" mode.



- *Engine brake*: Press "OK" for less than three seconds until "ENGINE BRAKE" appears.





Maintenance

- Press "SET" for less than three seconds. The display shows the current setting for engine brake.



- Press "OK" for less than three seconds; the displayed setting will start flashing.

- By repeatedly pressing "OK" for less than three seconds, the following settings can be displayed in sequence:

- "NORMAL"
- "SPORT"

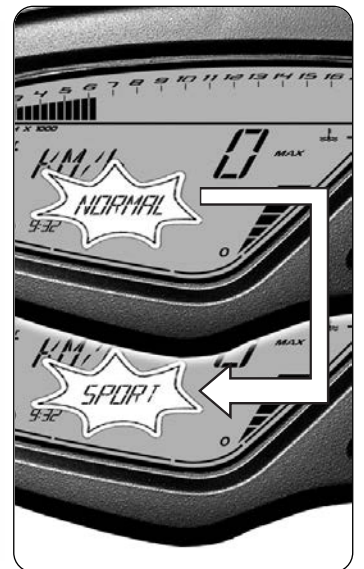

- Press "OK" for more than three seconds; the new setting will be confirmed. The displayed caption stops flashing and after a few seconds the display returns to "ENGINE BRAKE" mode.





Maintenance

- *Engine response*: Press “OK” for less than three seconds until “ENGINE RESPONSE” appears.

B

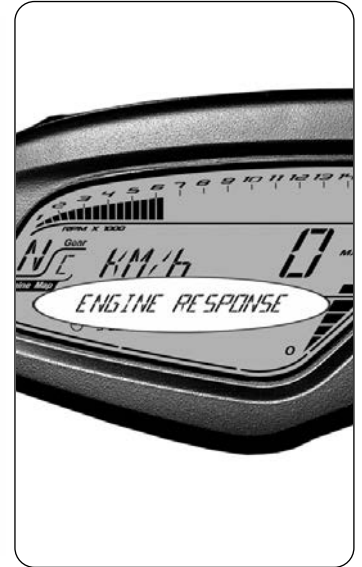

- Press “SET” for less than three seconds. The display shows the current setting for engine response.



- Press “OK” for less than three seconds; the displayed setting will start flashing.

- By repeatedly pressing “OK” for less than three seconds, the following settings can be displayed in sequence:

- “SLOW RESPONSE”
- “FAST RESPONSE”





Maintenance

- Press "OK" for more than three seconds; the new setting will be confirmed. The displayed caption stops flashing and after a few seconds the display returns to "ENGINE RESPONSE" mode.

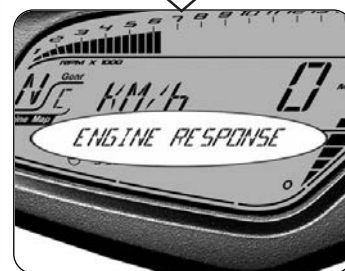
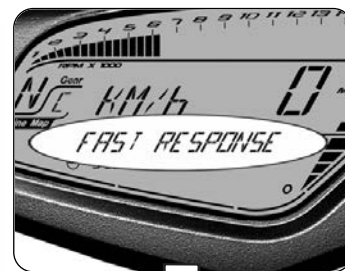

- *Engine RPM limiter:* Press "OK" for less than three seconds until "RPM LIMITER" appears.

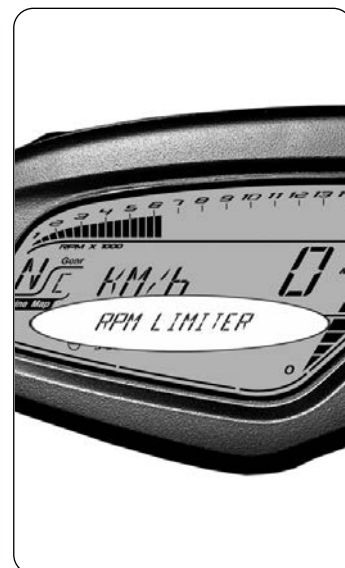

- Press "SET" for less than three seconds. The display shows the current setting for engine RPM limiter.

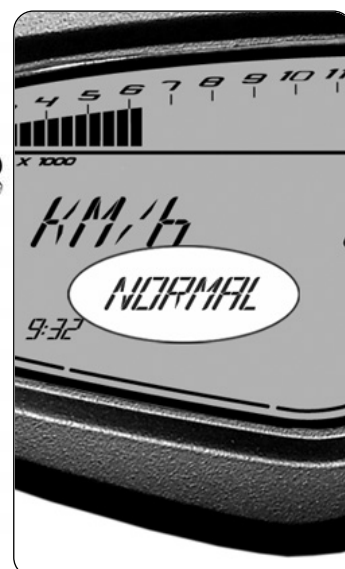



Maintenance

- Press "OK" for less than three seconds; the displayed setting will start flashing.

- By repeatedly pressing "OK" for less than three seconds, the following settings can be displayed in sequence:

- "NORMAL"
- "SPORT"

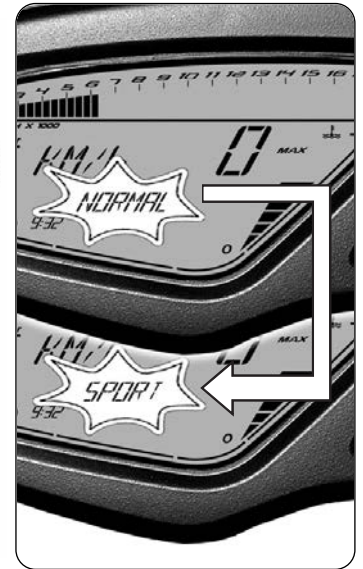

- Press "OK" for more than three seconds; the new setting will be confirmed. The displayed caption stops flashing and after a few seconds the display returns to "RPM LIMITER" mode.



- Press "OK" for less than three seconds until the display switches to the "RUN" mode. The setting of the "Custom" mapping is completed.

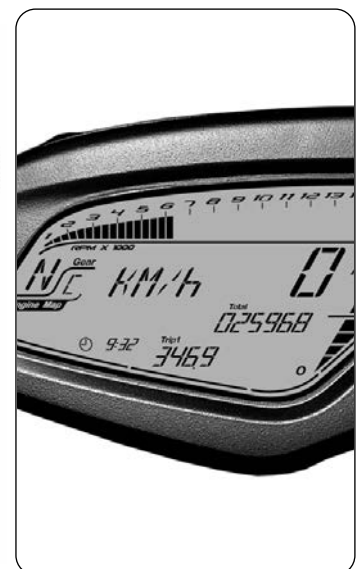



Warning/malfunction alerts

The dashboard may highlight the presence of a fault or a malfunction during different using conditions of the motorcycle.

- *Engine start:* As you turn the ignition switch to the ON position, the instruments and the warning lights will go through the self-diagnostic cycle. If the self-diagnostic cycle detects a fault in the vehicle, the display shows the warning alert shown in the picture. In particular, this message highlights the vehicle part or device on which the fault has been detected.



- Press "OK" button to access to "RUN" mode. The direction indicator emergency lights begin to flash.



WARNING

If a fault is detected on the vehicle when the engine is off, do not start engine.

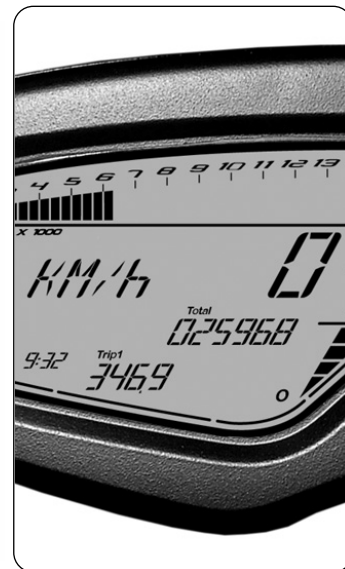

- *Fault during vehicle riding:* If a fault is detected during riding, the lower portion of the display shows the warning alert shown in the picture. The direction indicator emergency lights begin to flash.



WARNING

If a fault is detected during riding, stop the vehicle.





Maintenance

- After the vehicle is stopped, the display shows the warning message highlighting the vehicle part or device on which the fault has been detected.



- *High coolant temperature:* If a high value of the coolant temperature is detected, the display shows the warning alert shown in the picture. This message may appear during every using condition of the vehicle.



WARNING

If the coolant temperature is high, stop the motorbike and check the coolant level. If it needs to be filled up. If the warning alert appears even if the level is adequate, stop driving.

Dealer Menu

The instrumentation provides the opportunity to operate on an additional set of parameters.

The auxiliary functions available are:

- "SERVICE" (Scheduled maintenance expiration)
- "UNIT CHANGE" (Changes unit of measurement)

Viewing and editing modes of operation is performed in accordance with the procedures outlined in the paragraphs below.



WARNING

The modification or adjustment of display functions must be carried out with the engine off and running on neutral, with the motorcycle stopped with the stands on the ground. Changing display settings while running is prohibited.

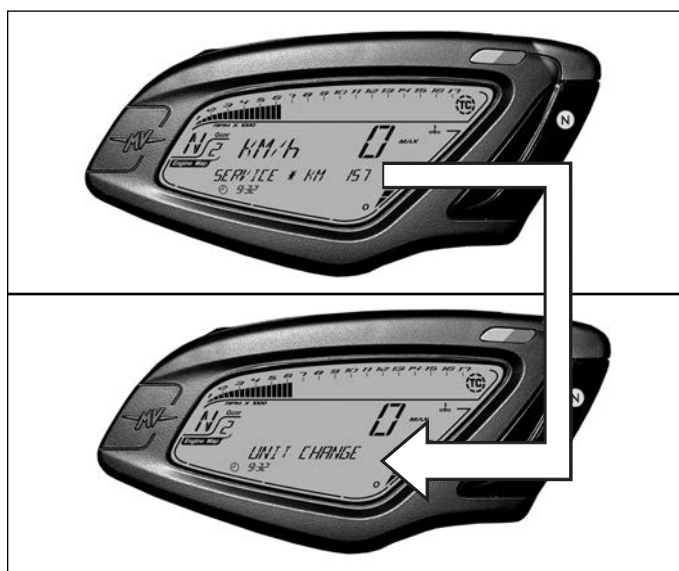



Maintenance

“SERVICE” Mode

This operating mode displays the mileage range with respect to expiration of the next scheduled maintenance.

NOTE

When the mileage range upon maintenance servicing is less than 1000 km, its relative value automatically appears after the start-up screen of the motorcycle.



“UNIT CHANGE” Mode

This function allows for simultaneous editing of the following units of measure:

- Speed
- Distance covered



“SERVICE” Mode

- Press the "SET" and "OK" buttons at the same time for more than ten seconds to access the "DEALER MENU".



WARNING

The modification or adjustment of display functions must be carried out with the engine off and running on neutral, with the motorcycle stopped with the stands on the ground. Changing display settings while running is prohibited.





Maintenance

- Press the "OK " button for less than three seconds until the message "SERVICE" is displayed. The mileage range with respect to expiration of the next scheduled maintenance is shown on this screen.

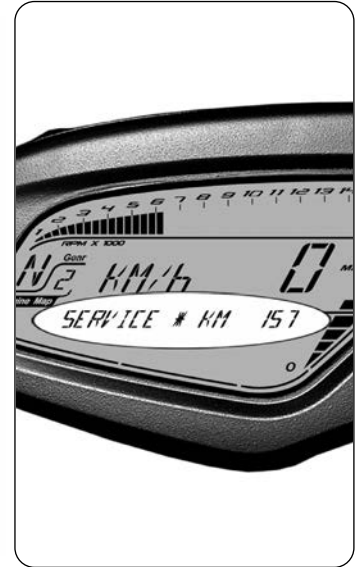

- *Mileage range resetting:* After performing scheduled maintenance, the mileage range must be reset using the following procedure.

- Access "SERVICE" mode and press the "OK" button for less than three seconds until the message "RESET KM" appears and the mileage range indicator light will begin to flash.



- Press the "OK " button for more than three seconds and the mileage range will be reset. The mileage range with respect to expiration of the next scheduled maintenance is shown on this screen.

- The next press of the "SET" button for less than three seconds will allow the user to return to the dashboard start screen.





Changing the unit of measurement

Allows for simultaneous editing of the following units of measure:

- Speed
- Distance covered



WARNING

The modification or adjustment of display functions must be carried out with the engine off and running on neutral, with the motorcycle stopped with the stands on the ground. Changing display settings while running is prohibited.

- Access the "SERVICE" mode as described in the preceding pages, and press the "SET" button for less than four seconds to until the message "UNIT CHANGE" appears.

- Press the "OK" button for less than three seconds and the unit on the speedometer will begin to flash.

- Press the "SET" button to pass from Km/h to Mph and vice-versa. Changing the unit of measurement on the speedometer automatically varies the following sizes:

- Odometer (total and partial): Km → mi
- Setting hour: 0 ÷ 24 → 0 ÷ 12 (am / pm)

If you press the "OK" button for longer than three seconds, the modification procedure of the measurement units will be interrupted.

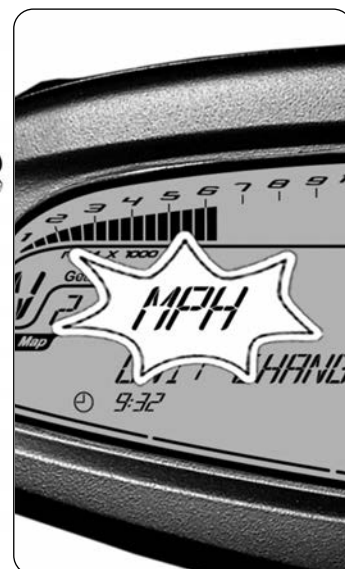
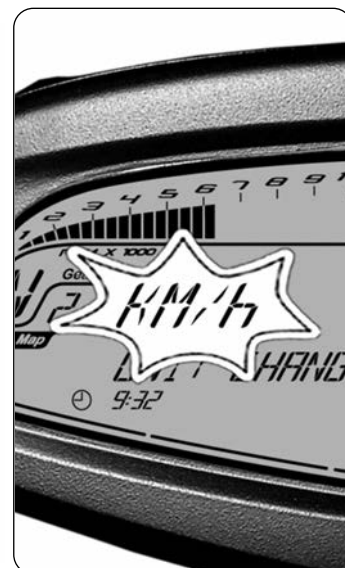
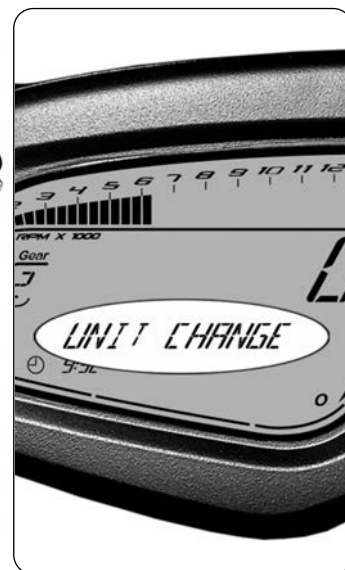



Maintenance

- Press the "OK " button for more than three seconds and the new unit of measurement configuration will be confirmed. The display returns to the "RUN" mode.

B



LIGHTS

Check → At the pre-delivery, at the first 1000 kilometres and then every 6000 kilometres.

If any of the warning lights or the main lights are burnt out, replace them as follows.

Replacing the headlight bulb

NOTE

To facilitate operations when replacing the driving/dipping beam bulb, it is advisable to remove the motorcycle beam. To do this, you must remove the vehicle headlight fairing as described in chapter C "Superstructures."

- Remove rear cap by turning it counterclockwise.





Maintenance

- Detach the connector.



B

- Release the retaining spring.



- Extract the bulb.



CAUTION - Do not touch the bulb glass with bare hands. If you do, clean the bulb with an oil-free solvent.

- Insert the new bulb.
- Reattach the spring.
- Reattach the connector.
- Replace the protective cap.



Replacing the front turn indicator bulbs

- Remove the fixing screw.



- Remove the lens.



- To remove the burnt-out bulb, press it and rotate it counterclockwise.



- To fit the new bulb, press it and rotate it clockwise.
- Refit the lens and tighten the fixing screw.



B

Replacing the rear turn indicator bulbs

- Remove the fixing screw.
- Remove the lens.

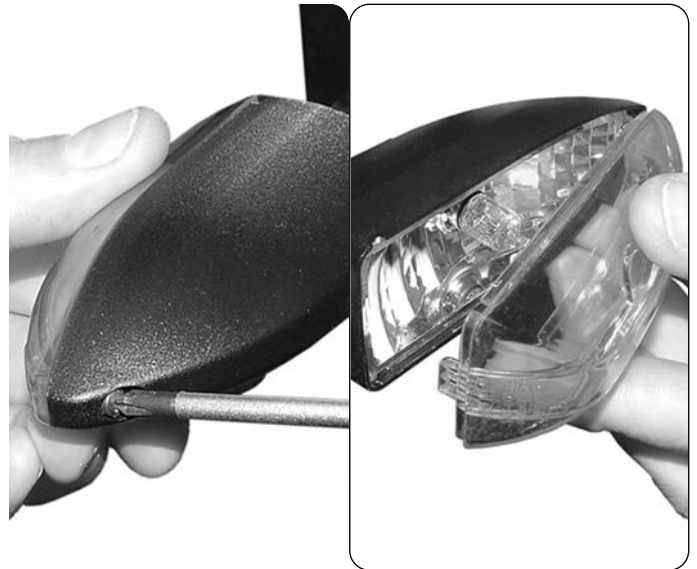

- Extract the bulb-holder and press the terminal ends of the bulb.

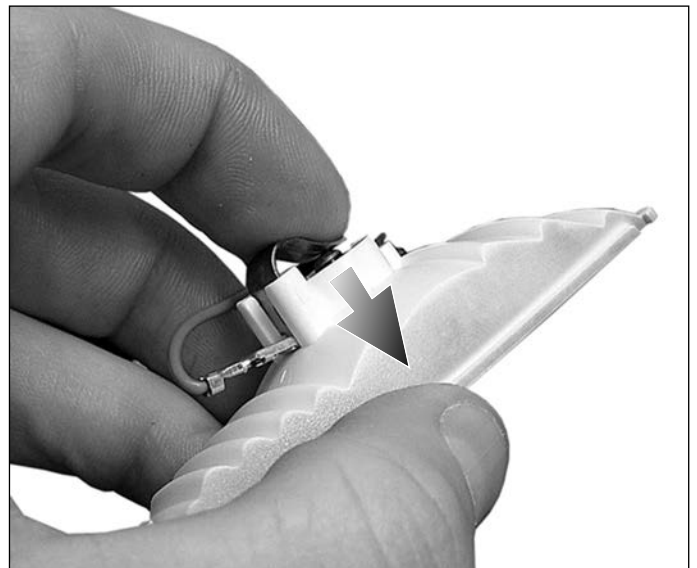

- To remove the burnt-out bulb, press it and rotate it counterclockwise.

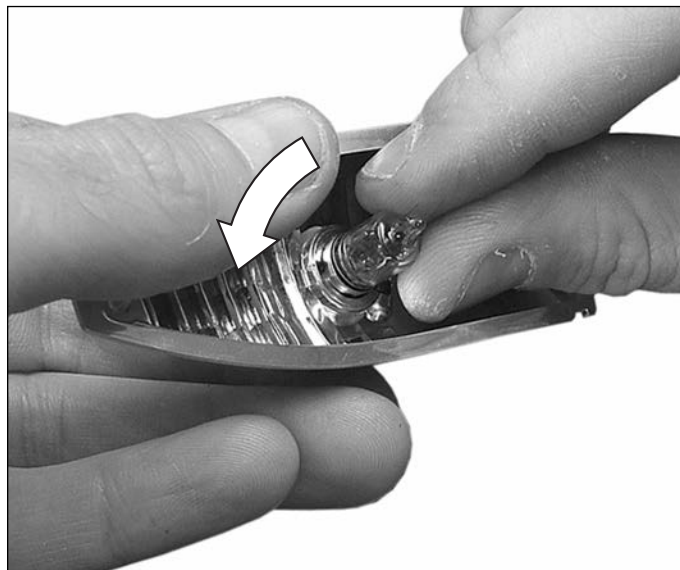

- To fit the new bulb, press it and rotate it clockwise.
- Replace the bulb-holder.
- Replace the lens and insert the fixing screw.

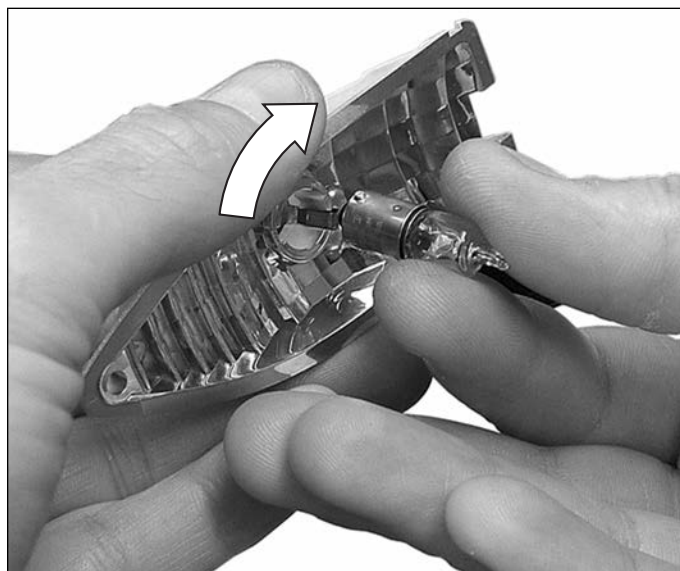

Replacing the license plate light bulb

- Remove the rear reflector, removing its fixing nuts.
- Remove the fixing screw of the plate holder.



- Remove the fixing nuts of the plate holder.
- Remove the plate holder.



- Extract the bulb holder pulling it from its seat.



- Extract the burnt-out bulb.
- Fit the new bulb.
- Replace the bulb holder.
- Replace the plate holder and the rear reflector.

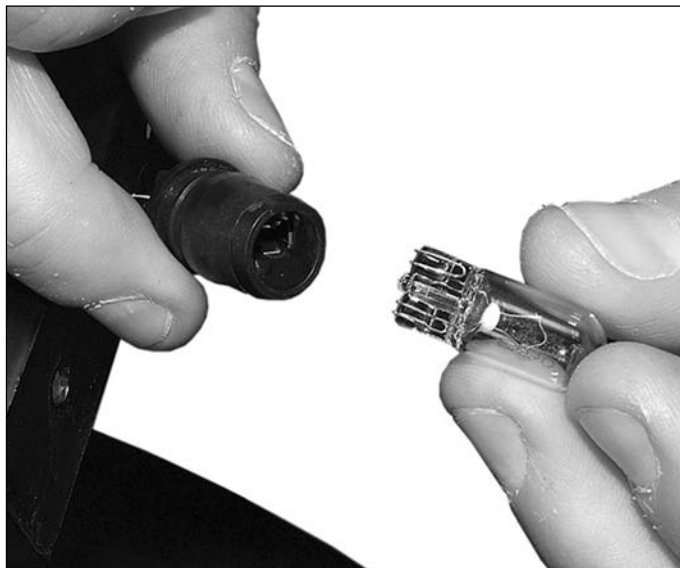

Replacing the tail light bulb

- Remove the two fixing screws of the rear tail plate.
- Remove the fixing bracket of the rear plate.

B

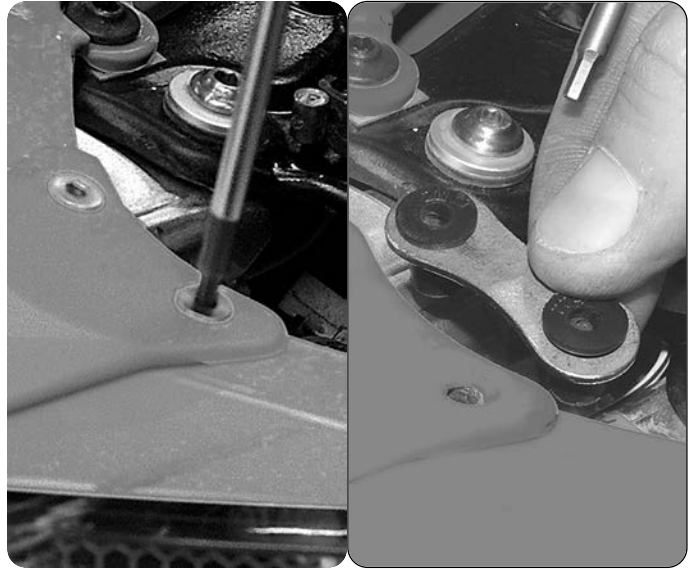

- Disengage and remove the rear tail plate.

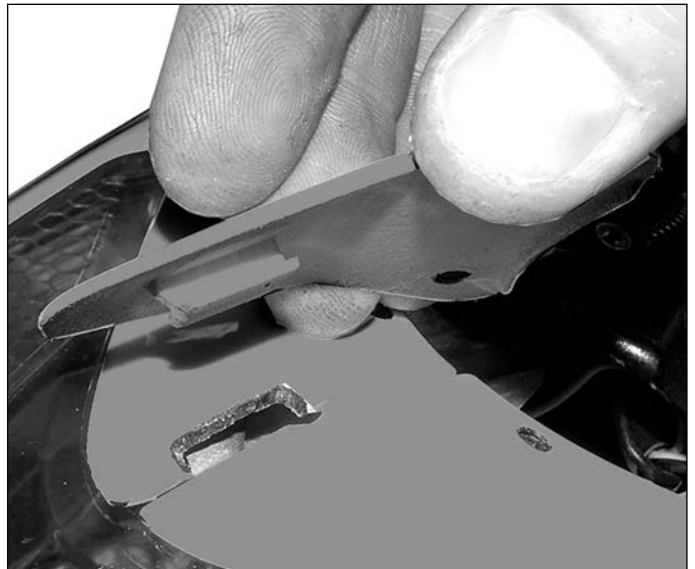

- Remove the four upper fixing screws of the tail side fairings.
- Remove the three fixing screws of the tail lamp.

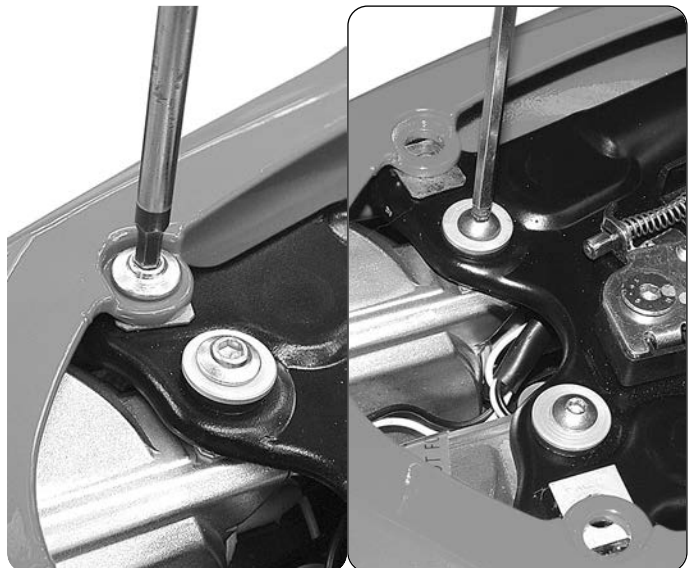

- Detach the tail lamp connector.

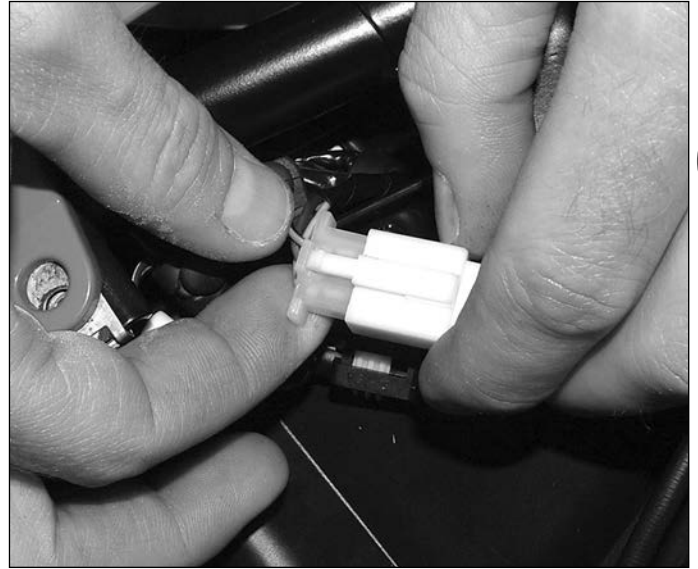

- Slightly open the tail side fairings and remove the tail lamp.

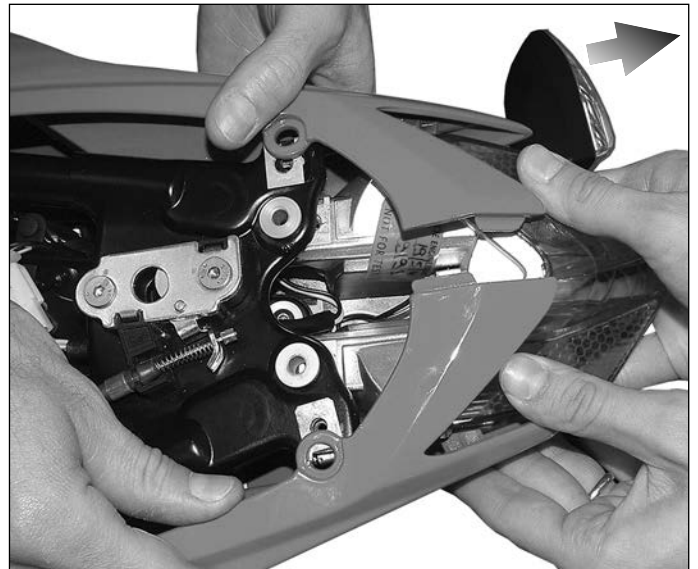

- Extract the bulb holder pulling it from its seat.
- Extract the burnt-out bulb.
- Fit the new bulb.
- Replace the bulb holder.
- Reassemble the tail lamp and all the previously removed parts.



Replacing the brake light bulb

- Remove the tail lamp as described previously.
- To extract the bulb holder, rotate it counterclockwise.

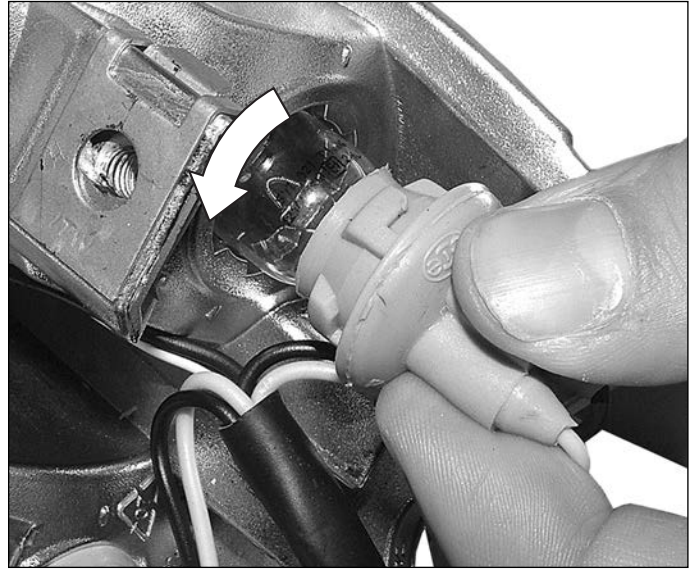

- Extract the burnt-out bulb.
- Fit the new bulb.
- Replace the bulb holder by rotating it clockwise.
- Reassemble the tail lamp and all the previously removed parts.



FUSES

- The battery recharge fuse is located on the solenoid starter of the motorcycle. To expose it, remove the right side fairing of the motorcycle.



CAUTION

Turn the ignition key on the "OFF" position before checking or replacing the fuses, in order to avoid a short circuit with subsequent damage to other electric parts of the motorcycle.

- To replace the fuse, you must swap the recharge fuse with the spare fuse.

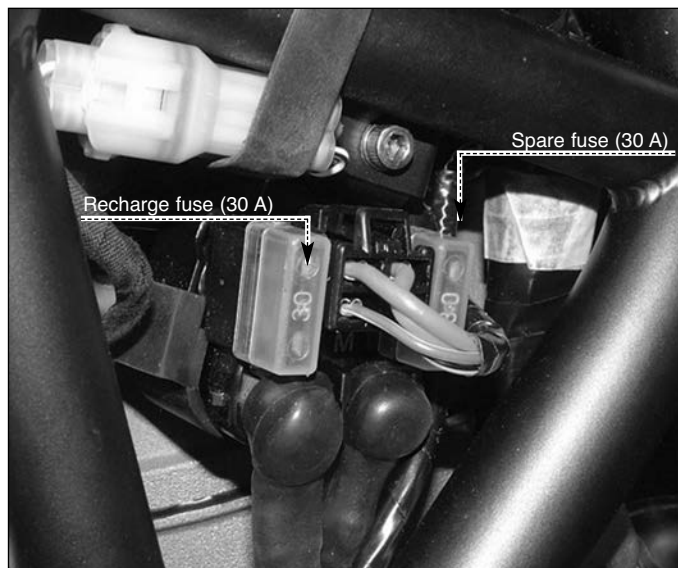

WARNING

Never replace a fuse with a rating other than that prescribed, in order to avoid damage to the electrical equipment of the motorcycle which could lead to a fire.

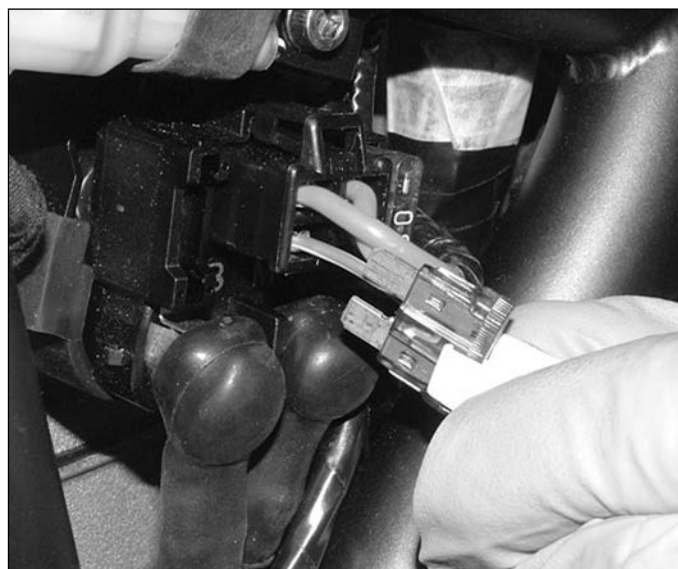



Maintenance

- The service fuses are located on the right side of the motorcycle.
- Release the two clamps and lift the fuse box cover.

B



CAUTION

Turn the ignition key on the "OFF" position before checking or replacing the fuses, in order to avoid a short circuit with subsequent damage to other electric parts of the motorcycle.



- Replace the blown fuse and refit the cover.





Maintenance

- To identify the position and function of the fuses, refer to the information shown in the enclosed electrical diagram. The reference letters in the figure correspond to those shown in the diagram.

Remember that the fuse box contains three spare fuses.



WARNING

Never replace a fuse with a rating other than that prescribed, in order to avoid damage to the electrical equipment of the motorcycle which could lead to a fire.

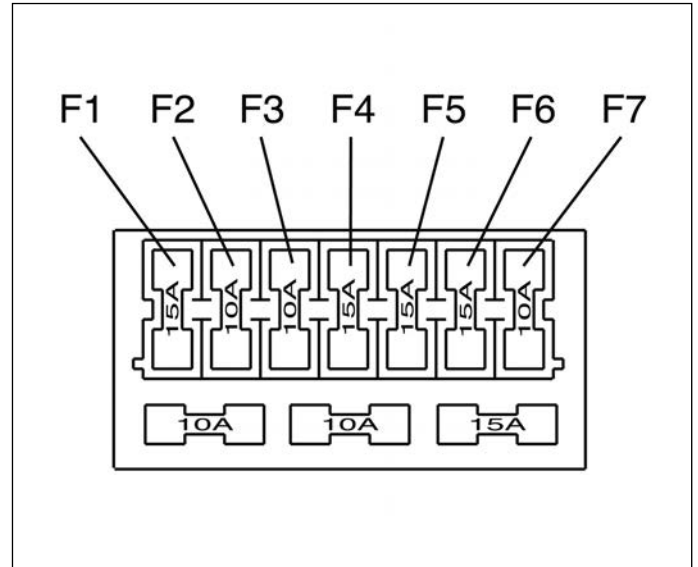

B



Maintenance

FRONT HEADLAMP

Check adjustment → At every variation of the motorcycle set-up.

The headlight should be adjusted every time the geometry of the vehicle is altered and before carrying a pillion passenger. The motorcycle is not equipped with external adjusters and the front projector unit is fixed to the frame.

Headlight adjustment

Place the vehicle at a distance of 10 m from a vertical wall. Make sure that the motorcycle is placed on an even horizontal surface, and that the headlight's optical axis is perpendicular to the wall.

The vehicle must be held in an upright position. Measure the "X" distance between the headlight center and the ground surface, then trace a small cross on the wall at the same height.

When you turn the headlight on, the upper boundary line between the dark area and the lighted area must be at an height equal or lower than the 9/10 of the headlight center height.

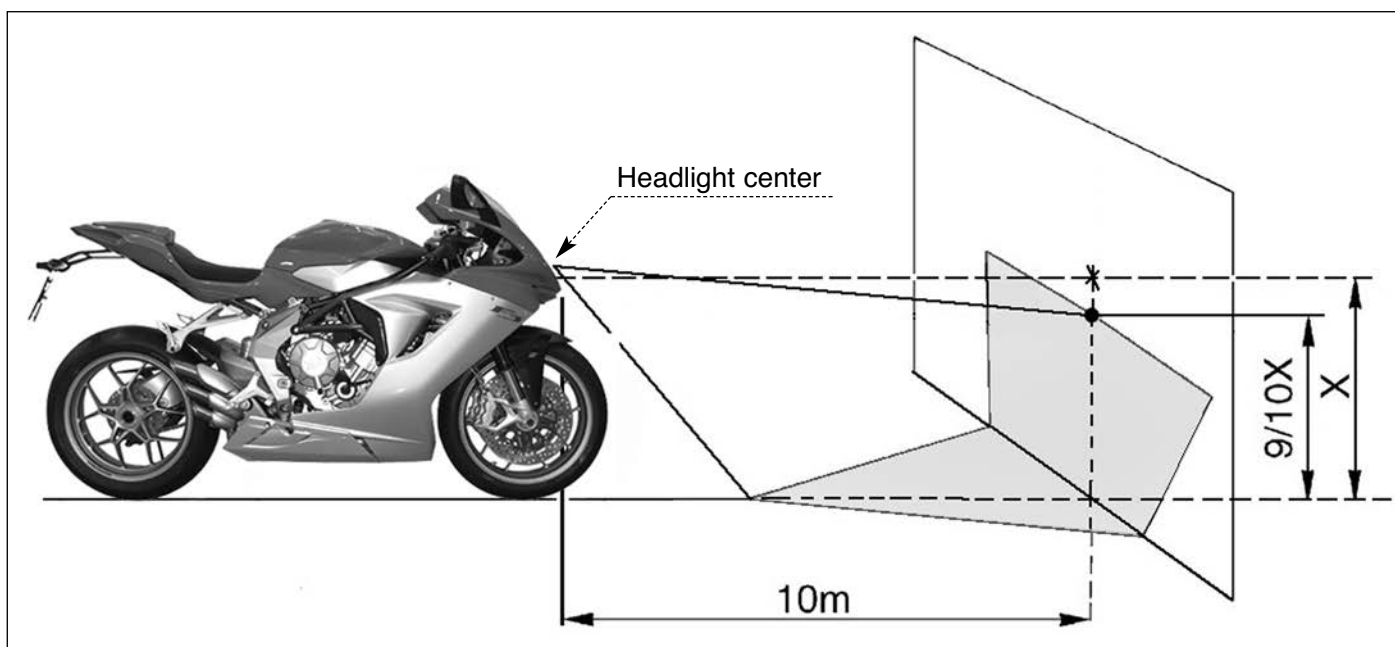

The light beam can be adjusted vertically by turning the screw illustrated. If turned in a clockwise direction: the optical unit tilts upwards. If turned in an anti-clockwise direction: the optical unit tilts downwards. It can be tilted up to an angle of $\pm 4^\circ$ from the standard position.

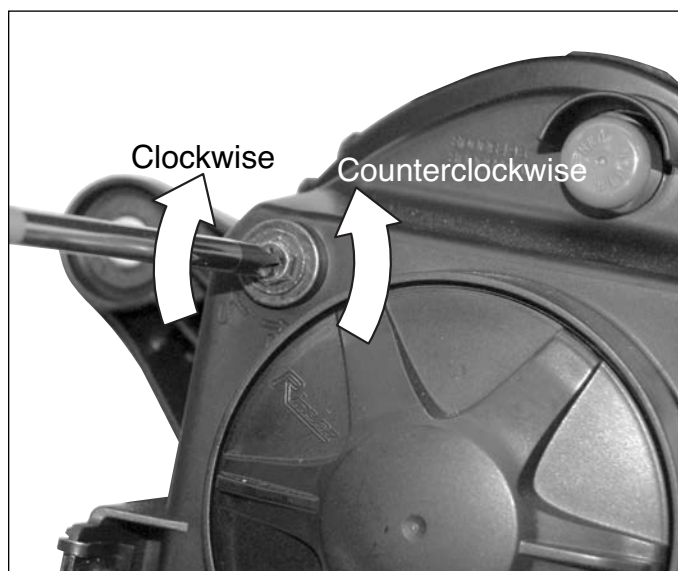



Bodywork

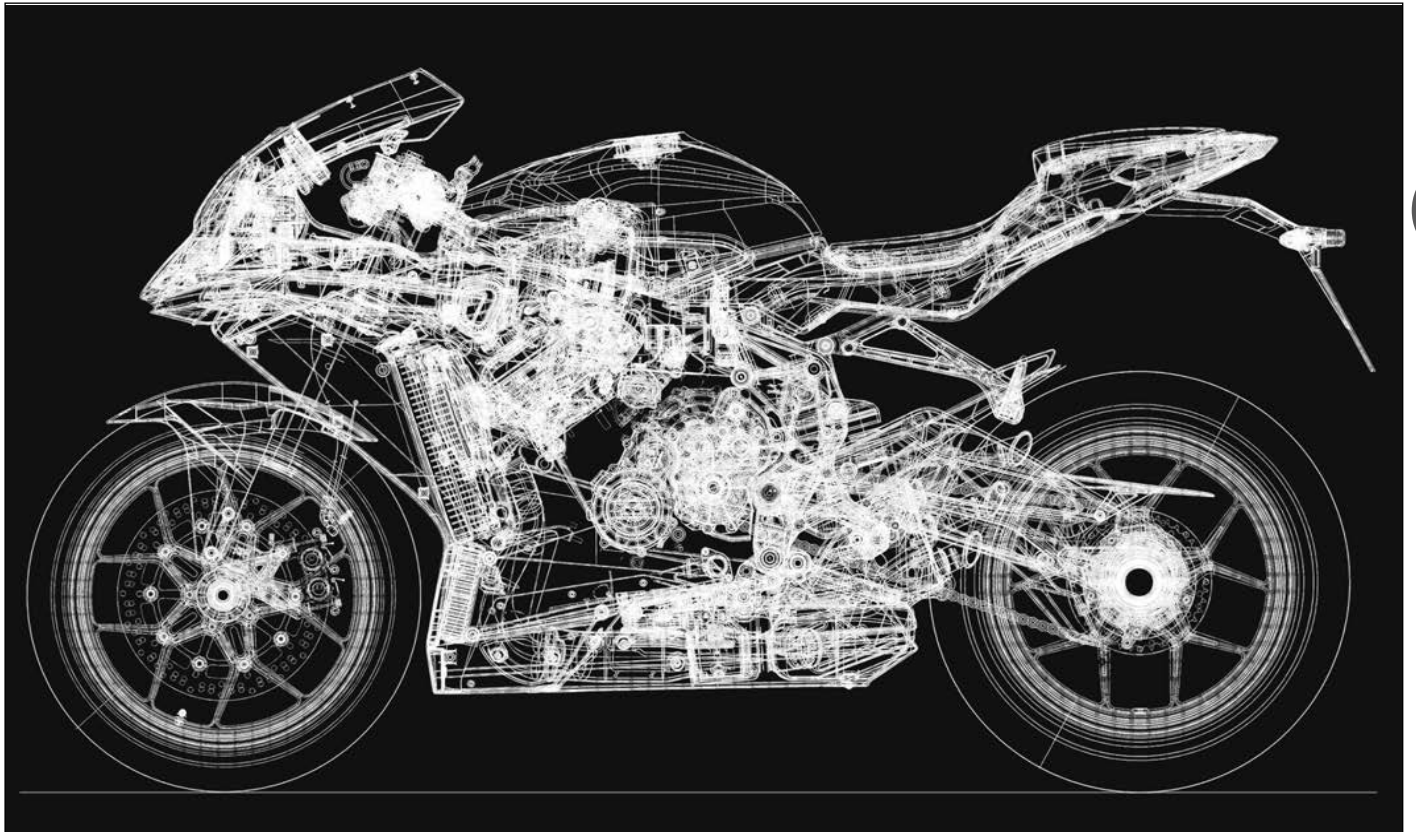

C

SECTION C
Revision 0



SUMMARY

FAIRING ASSEMBLY	PAGE 3
TAIL UNIT AND HEAT SHIELD	PAGE 8
FUEL TANK AND INTAKE AIR DUCT	PAGE 12
AIR INTAKE SYSTEM	PAGE 18
MUDGUARD - CENTRAL CONVEYOR - RADIATOR PROTECTION	PAGE 23

FAIRING ASSEMBLY

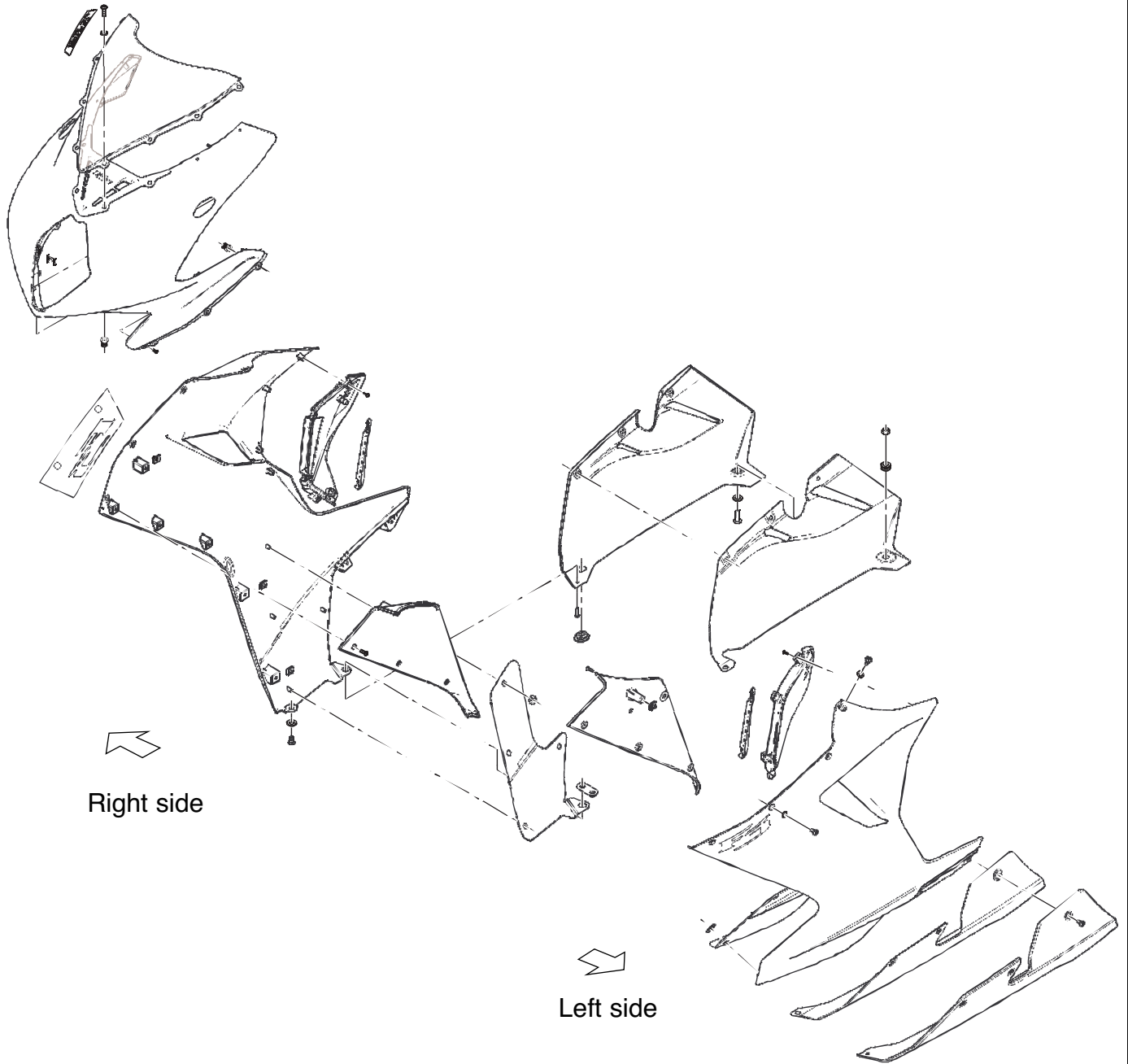

• This exploded view demonstrates the position of the bodywork and the method of disassembly and assembly.

Under-engine fairing removal

Proceed to remove the four clamping items of the right under-fairing located respectively:

- two screws (1) on the top side part;

NOTE: do not remove the third screw (2) on the rear part.

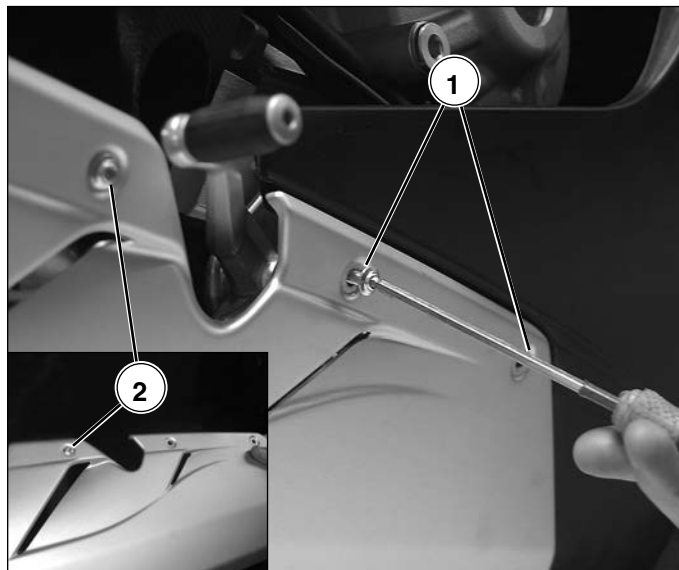

- Two screws (3) in the bottom part (1 rear and 1 front);

Repeat the operation on the corresponding clamping items of the left under-fairing.

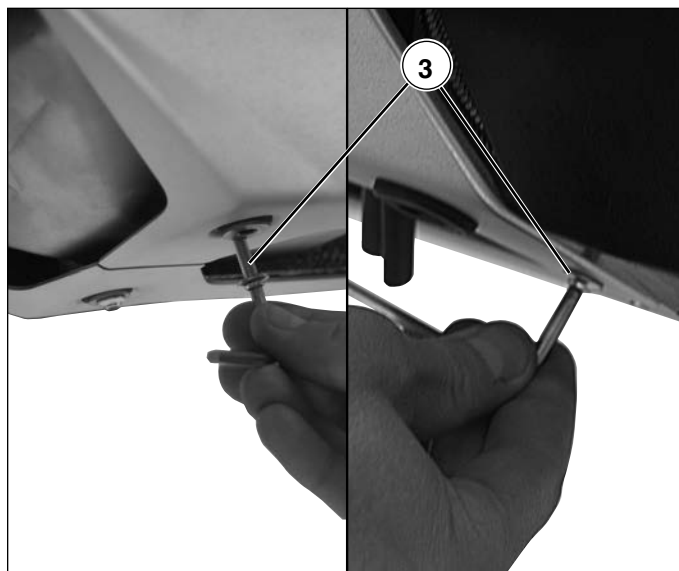

Fairing side panel removal

Remove the six fixing bolts (1) situated on the right fairing side panel.

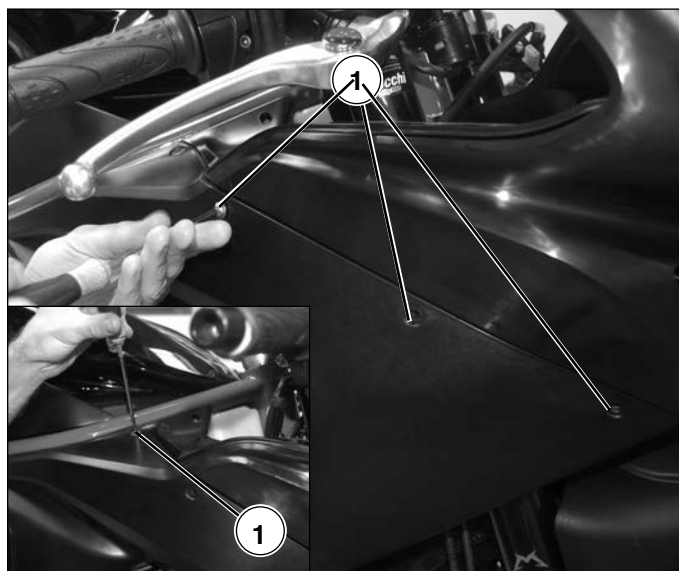

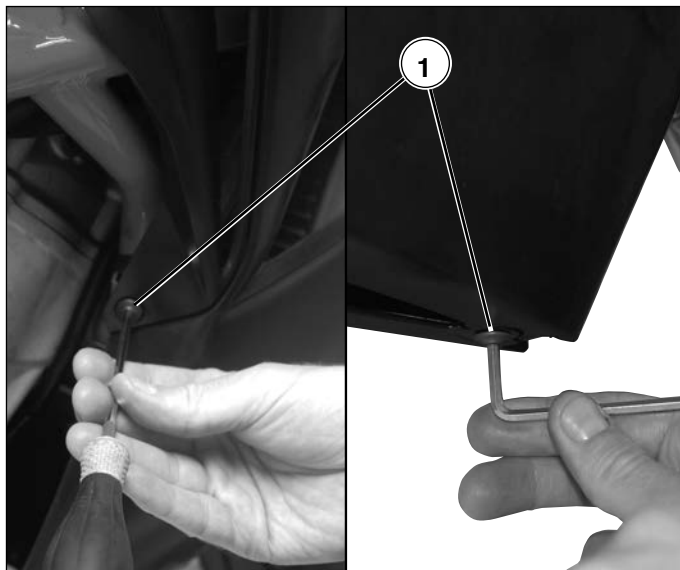

C

Unhook the pin (2) clamped to the frame.

Remove the fairing side panel, sliding it off from the front side.

Repeat the operation for the left fairing side panel.

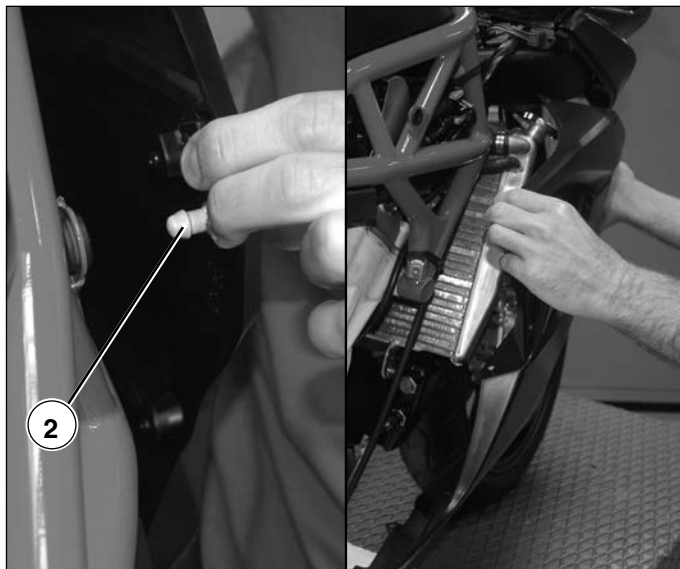

To separate the air manifold from the side panels, removing the four fixing screws (3).

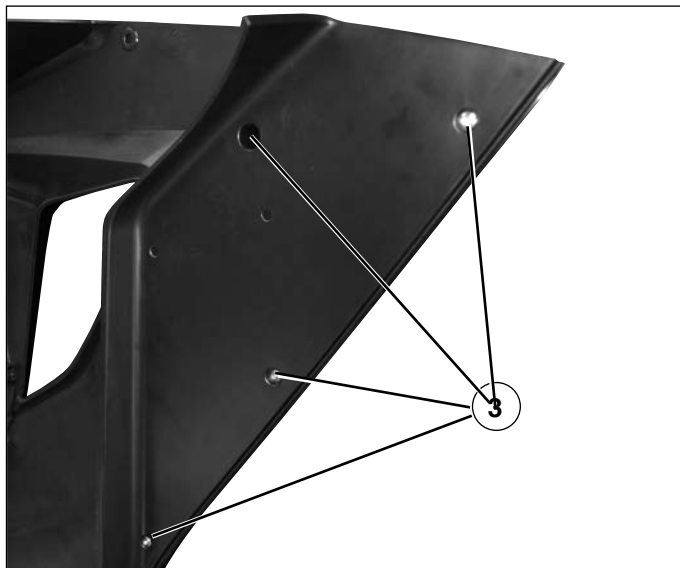



Bodywork

Front fairing removal

Remove the two screws (1) that clamp the light onto the low beam support on both sides using a 5 mm ball head hex screwdriver.



Remove the two fixing screws (2) of the headlight fairing to the instrument panel support.



Remove the four screws (3), two per side, that fasten the front cowl to the air ducts covers.

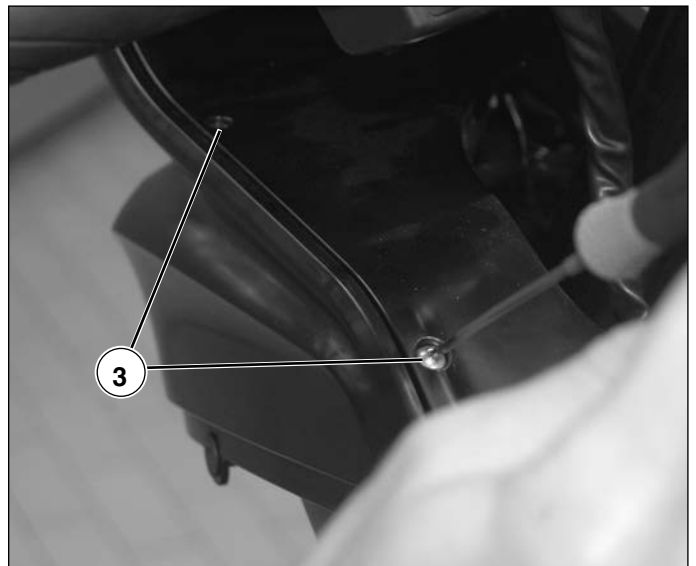

Remove the two fixing screws (4) of the right rear-view mirror.

Remove the connector (5) and take off the right rear-view mirror.

Repeat operations for the left mirror.

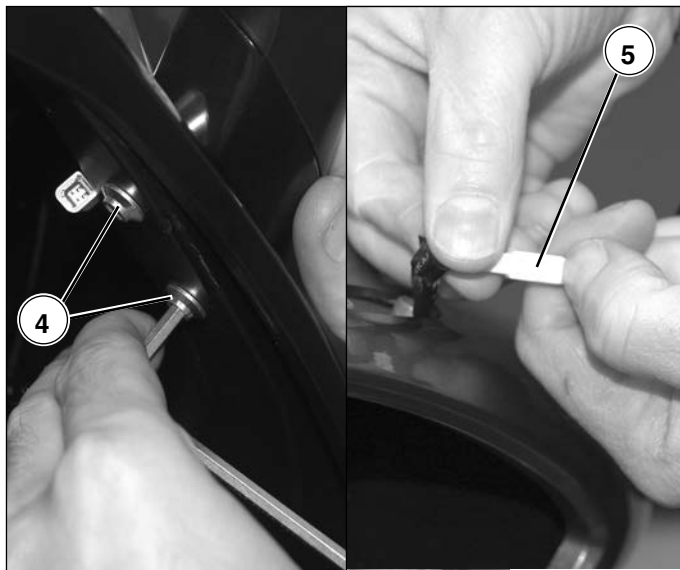

Remove the headlight fairing, sliding it toward the front part. The headlight will remain fastened to the fairing.



Slide the front headlight connector (6) out by unscrewing it counter-clockwise.

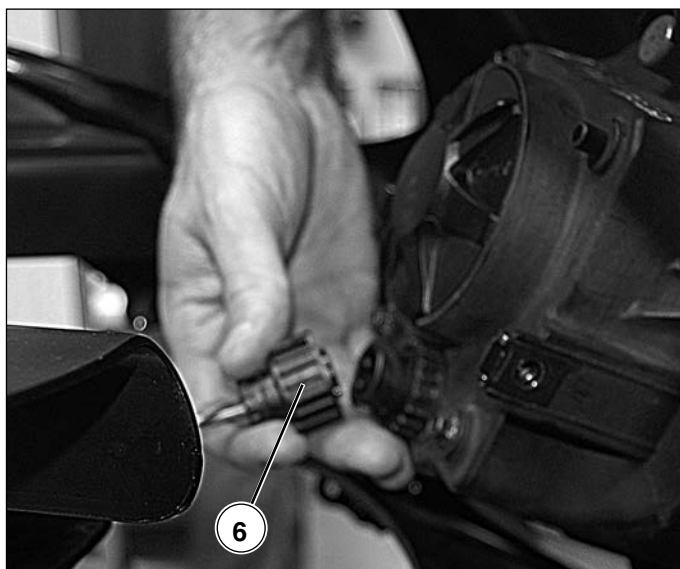

TAIL UNIT AND HEAT SHIELD

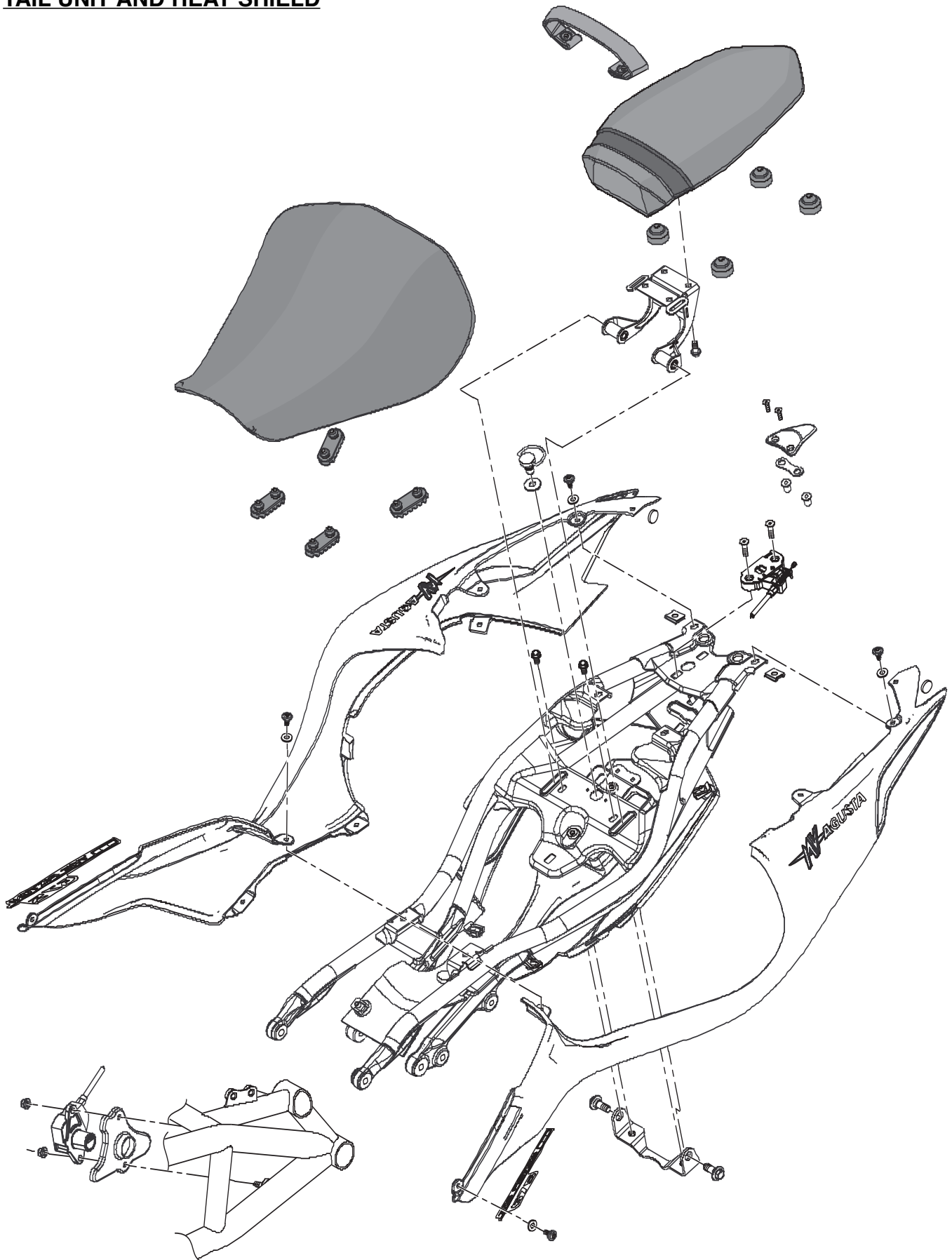



Bodywork

Tail unit removal and heat shield

Insert the ignition key into the seat lock.
Press lightly on the rear part of the passenger seat as shown in the figure.
Turn the key and unlock the seat.



Lift up the passenger seat.



Unscrew the screw (1) counter-clockwise and slide the driver's seat forwards.

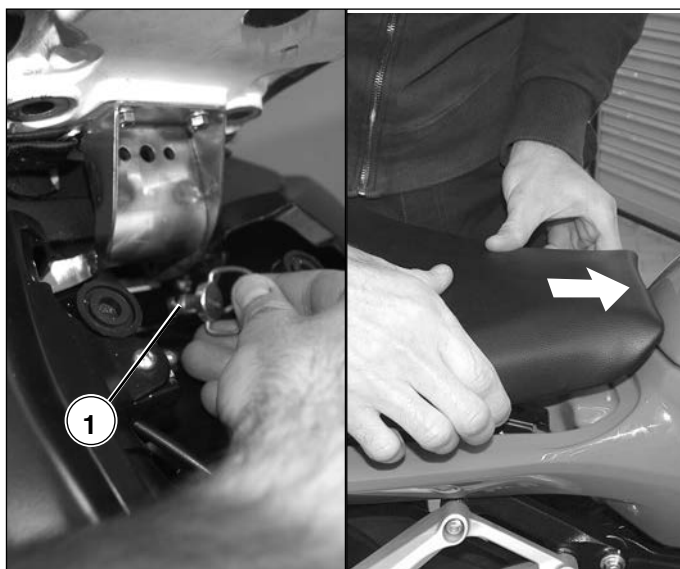



Bodywork

Remove the tank side fairings (1) on both sides, unhooking it from the pin and sliding it toward the front part of the motorcycle (page C-13).

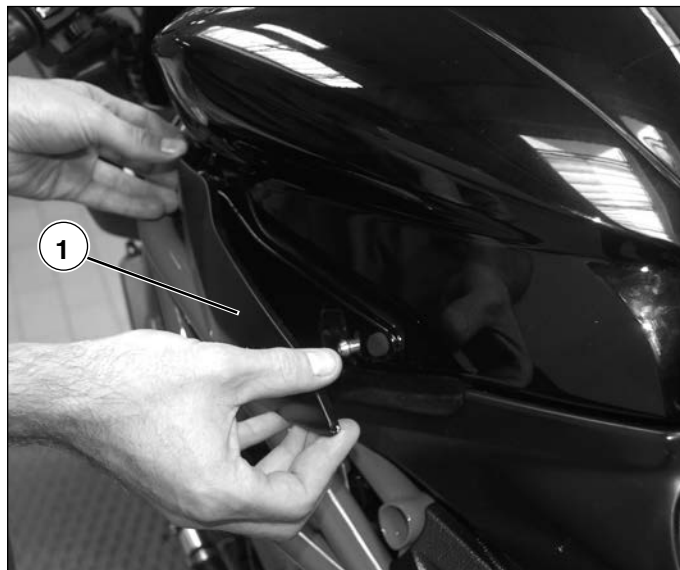

Remove the right and left under seat side fairings removing the 12 screws (2).

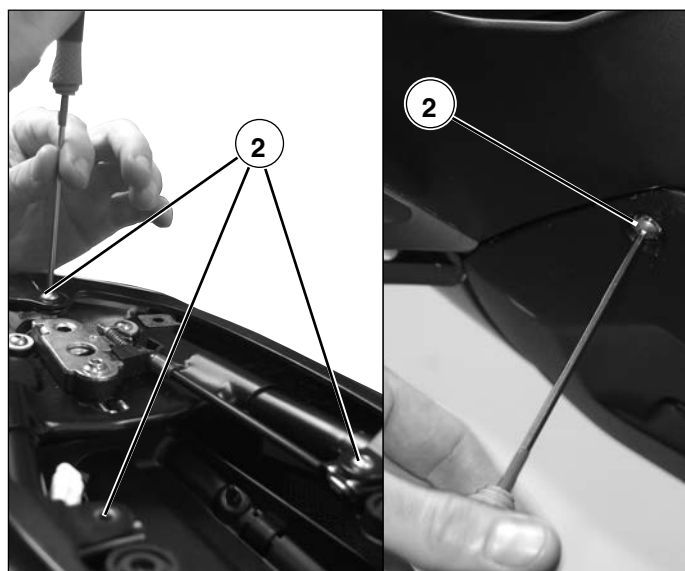
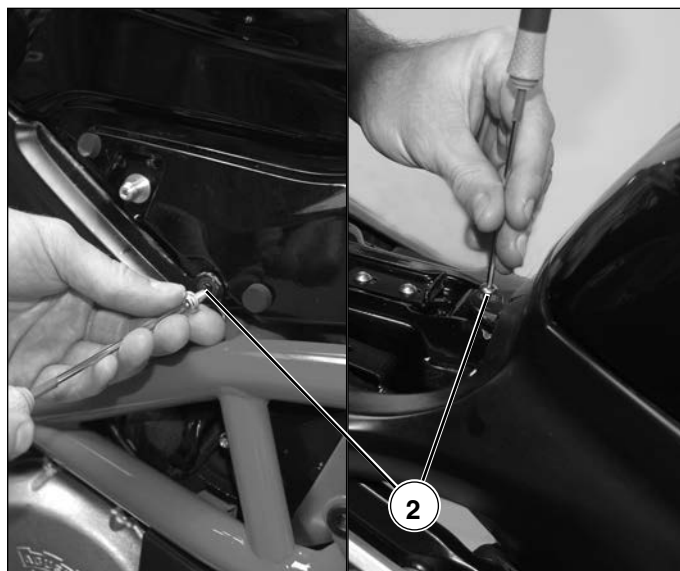

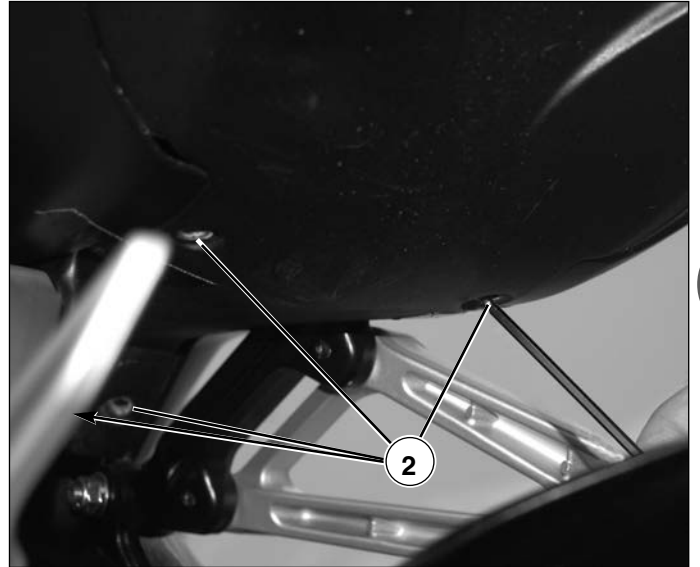

C

Remove the side fairing toward the outside.



Turn and slide the heat shield towards the rear part that has been freed up by taking down the underseat panels.



FUEL TANK AND AIR INTAKE DUCTS

C

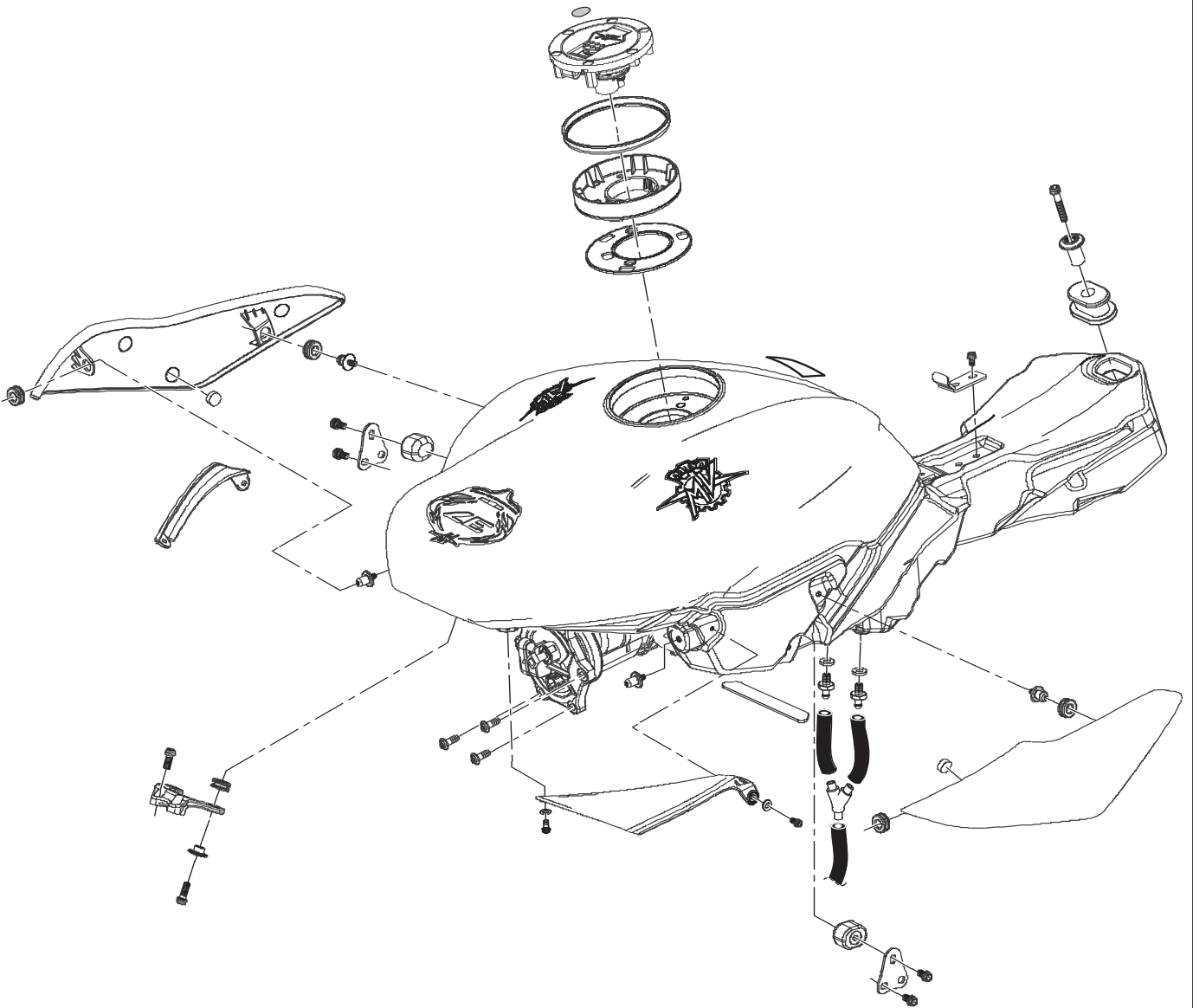

Side fairing removal

Extract the left and right side fairing support (1) as indicated in the figure.

Unhook the rear part of the panel (A) from the clamping pin, then remove it by sliding it (B) towards the front of the vehicle.

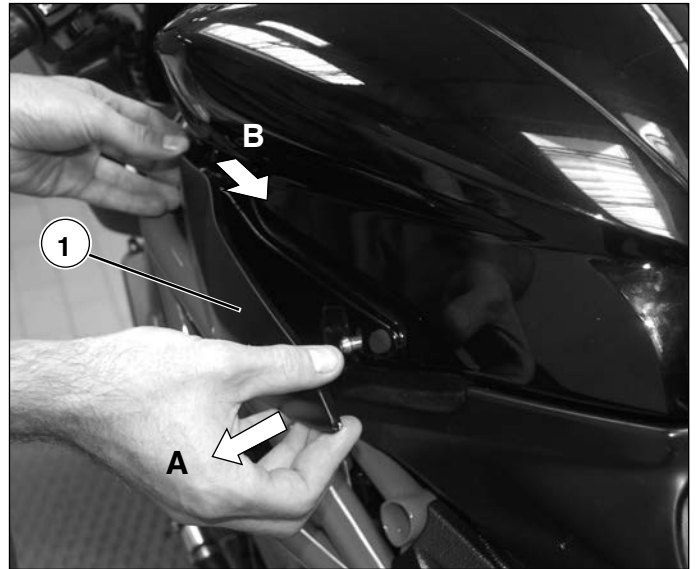

C

Fuel tank removal

Remove the rear fixing screw of the fuel tank (1).

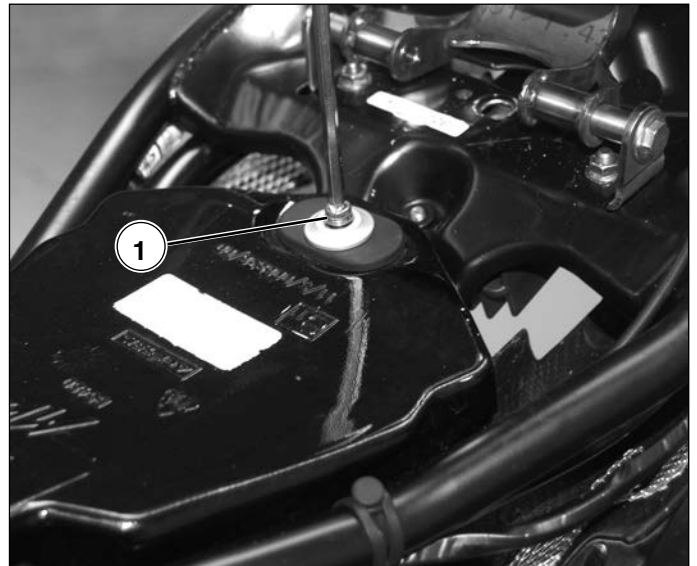

Remove the two front fixing screws (2).

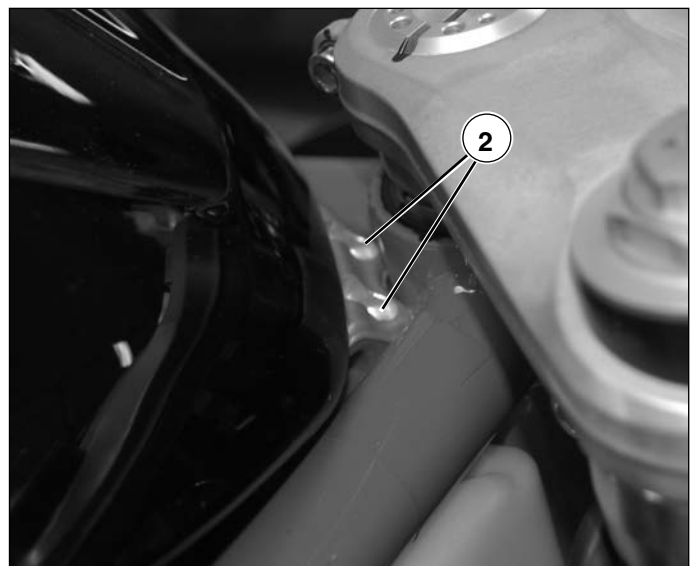



Bodywork

Remove the two side screws (3) that clamp the triangular plate to the frame on both sides.

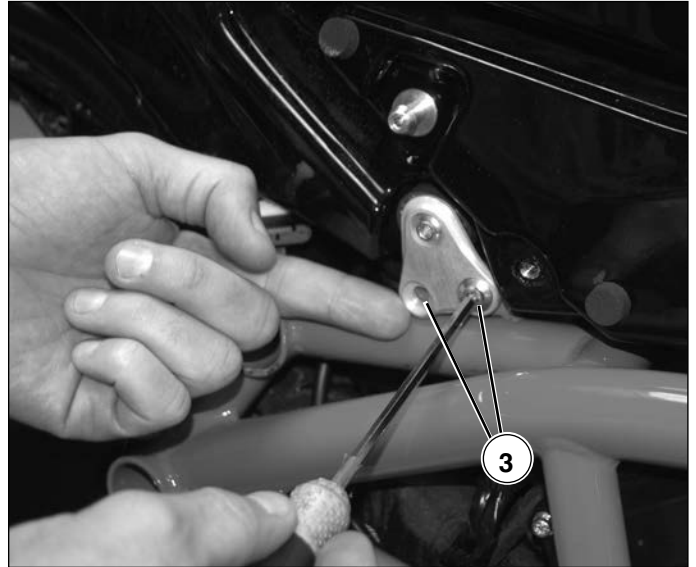

Free up the tank vent pipe by opening the three (4) rubber clamps.

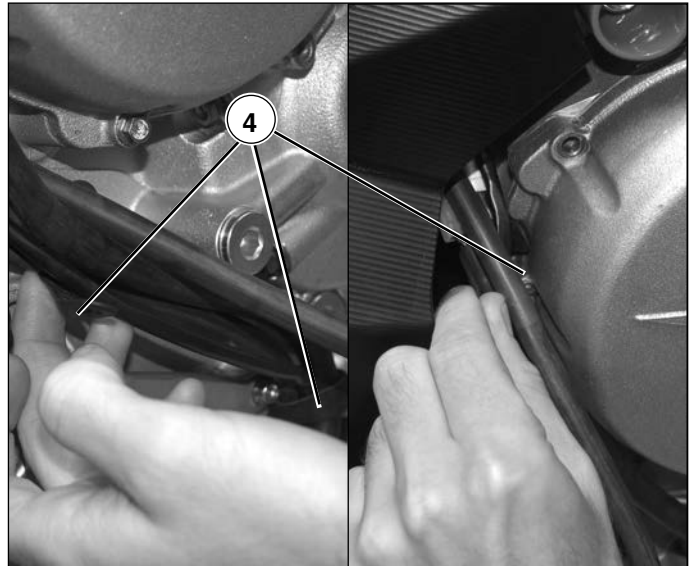

Disconnect the petrol pipe (5) from the three-way connector on the left side of the motorcycle.

 **To disconnect the fuel tube, press and slide the retaining slide as shown in the figure.**

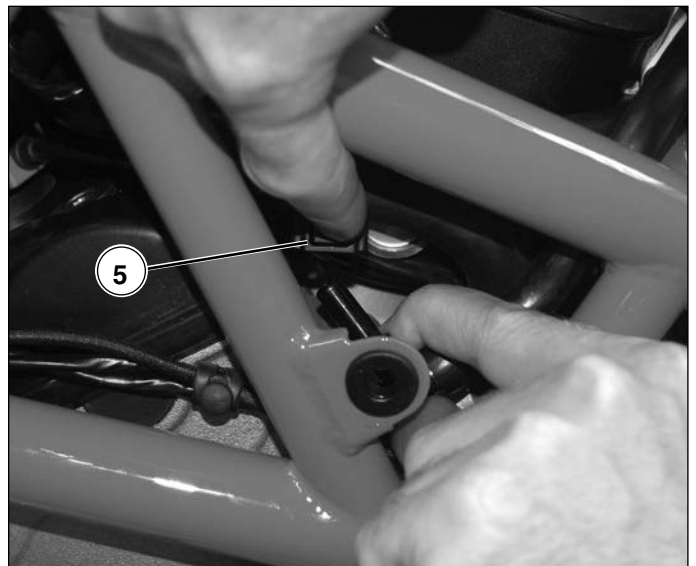

Disconnect the petrol pump by disconnecting the 5-way electric connector (6).

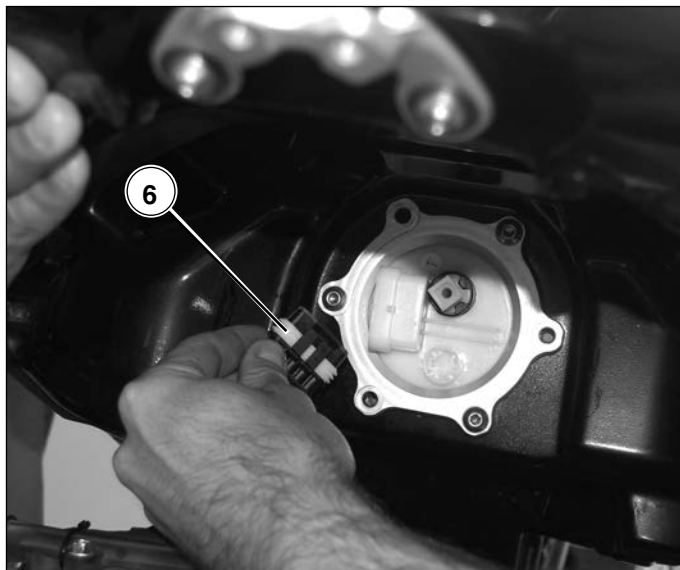

Lift up the fuel tank.



While lifting the tank take care not to damage the airbox.



Disassemble the duct cover panels

Remove the two connecting screws (1) of the left panel (2) of the frame.

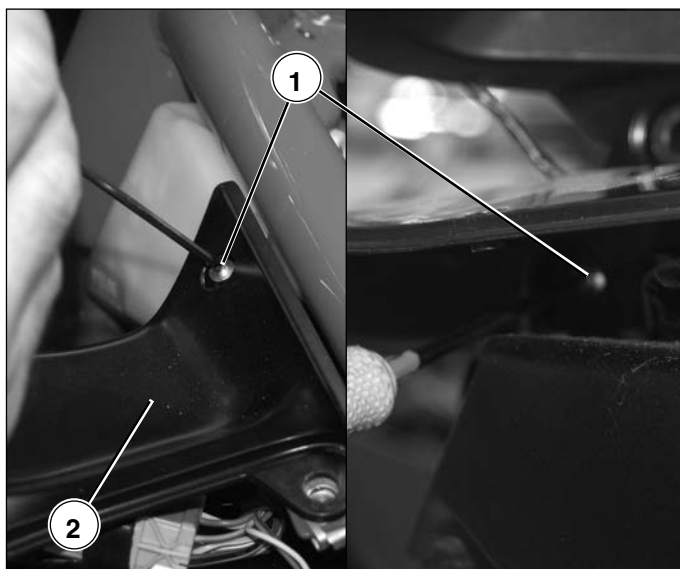



Bodywork

Lift the panel and unhook it from the two pins.
Remove it outward.

Repeat operations for the left panel.



Unhook the snap fastener on the left line that clamps down the electric cable (3) of the left direction indicator.

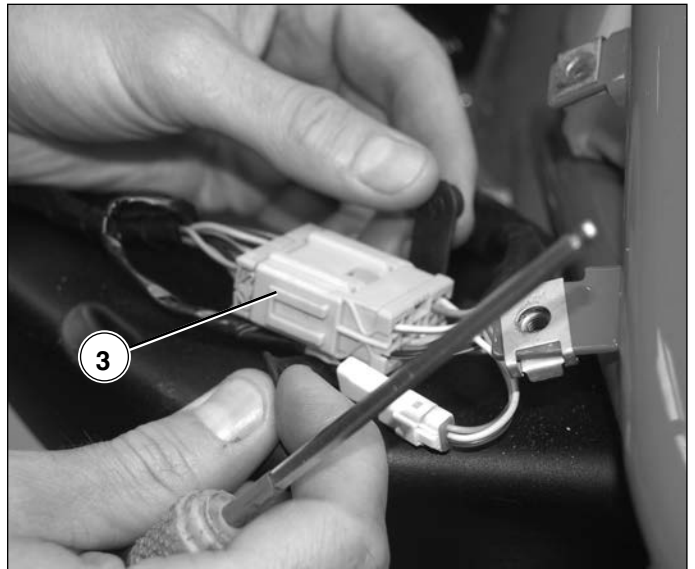

Unhook the snap fastener (4) from the right air line and cut the plastic clamp (5) that clamps down the electrical system.

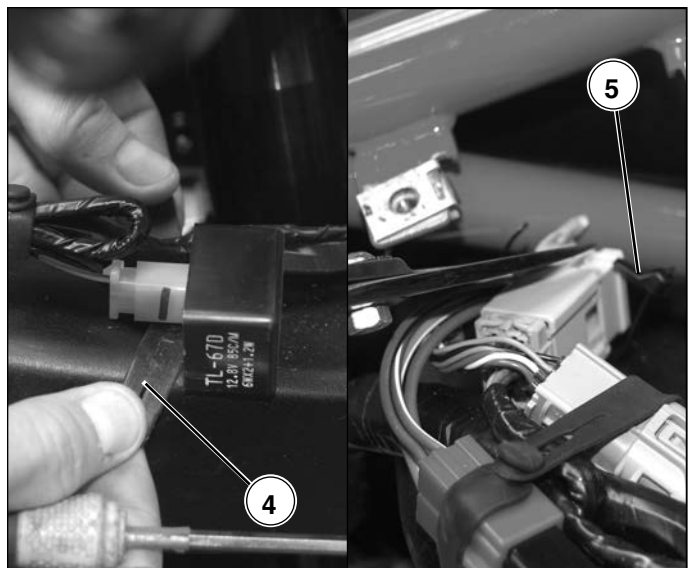

Left and right air intake conduit removal

Remove the six screws (1) that fasten the air lines to the airbox (three per side).

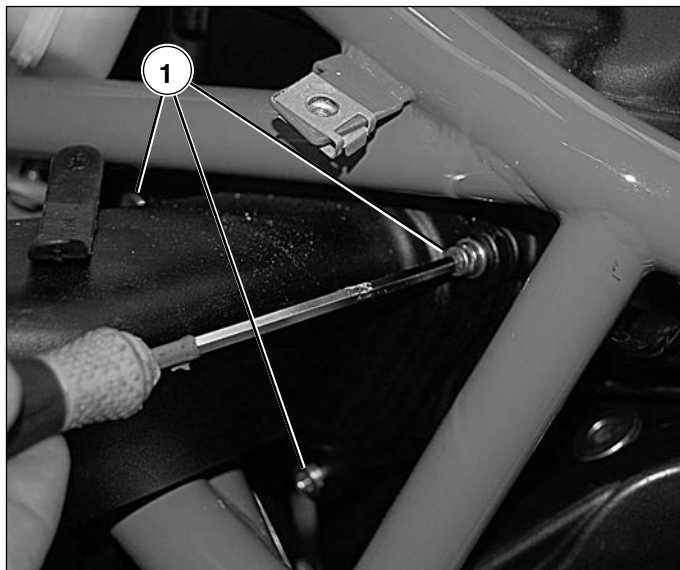

At this point you must remove the right and left suction lines (2) by making them come out from the top part first.



C

AIR INTAKE SYSTEM

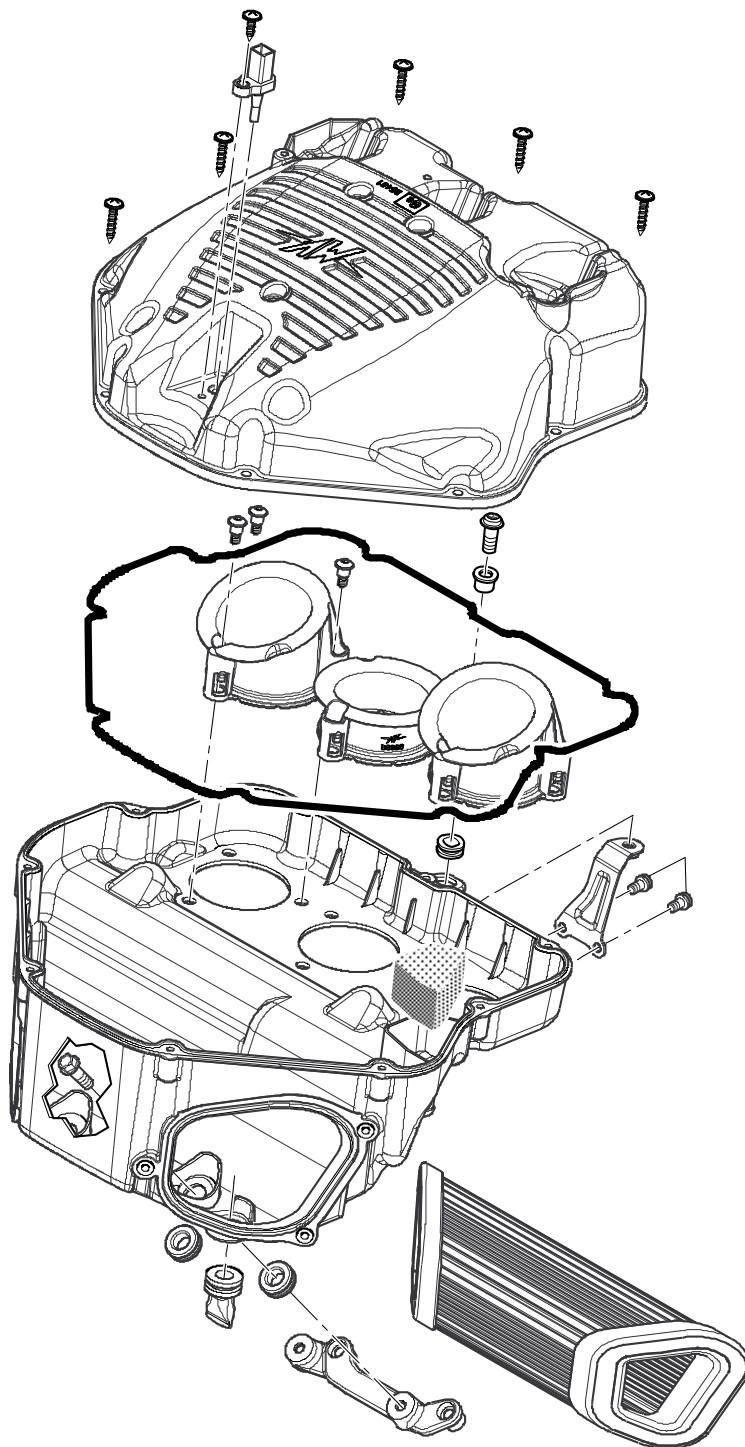

Airbox removal

Remove the 9 fixing screws (1) of the airbox cover.

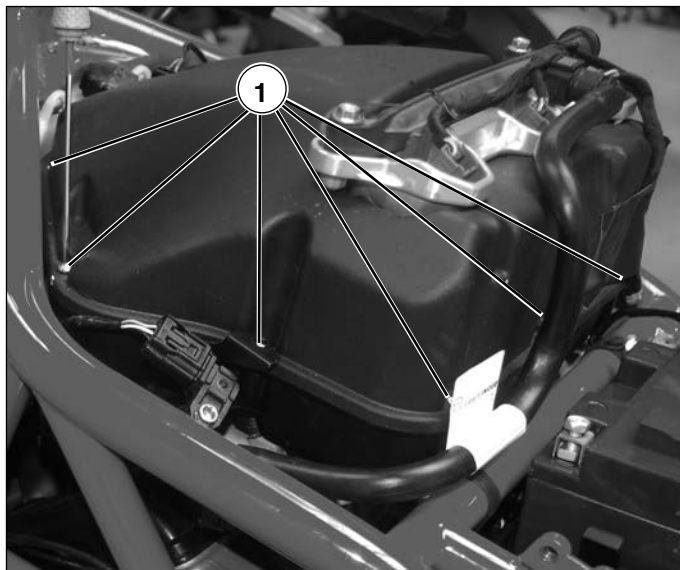

Unhook the top petrol injection pipe (2) by pressing the coloured button on the connector.

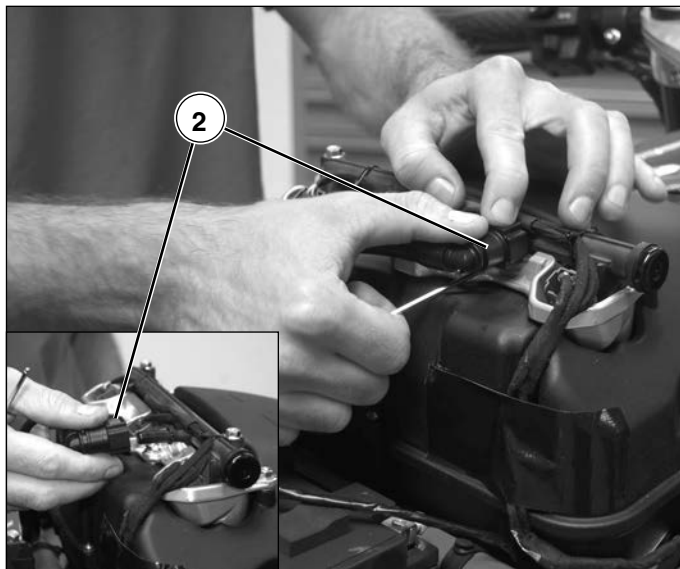

Remove the snap fastener (3) and then disconnect the electric connector (4)

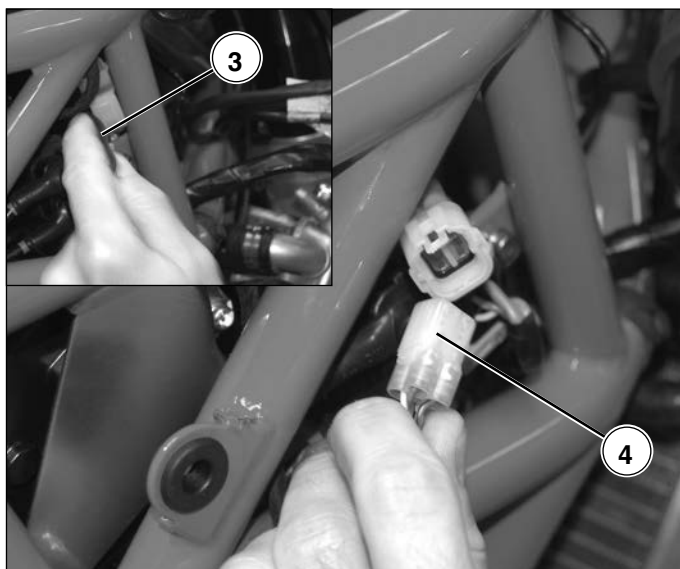

C

Disconnect the air temperature sensor connector (1).



Lift and remove the air box cover.

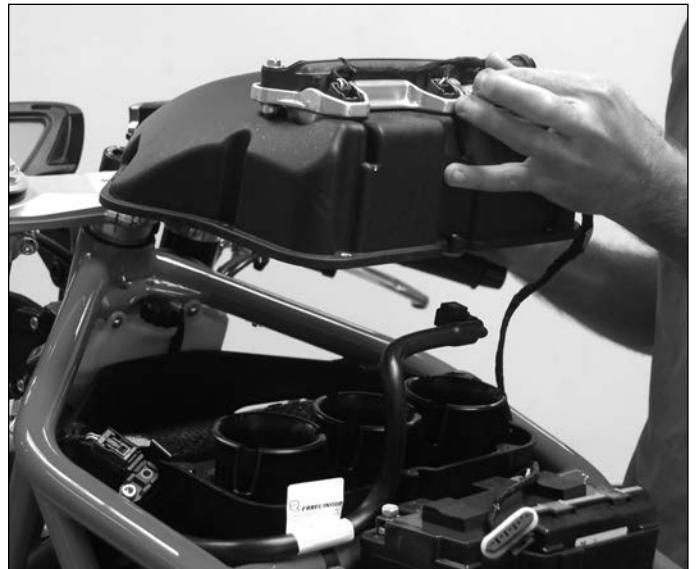

Pull the ECU unit rubber mounting (2) out upwards from the battery housing.

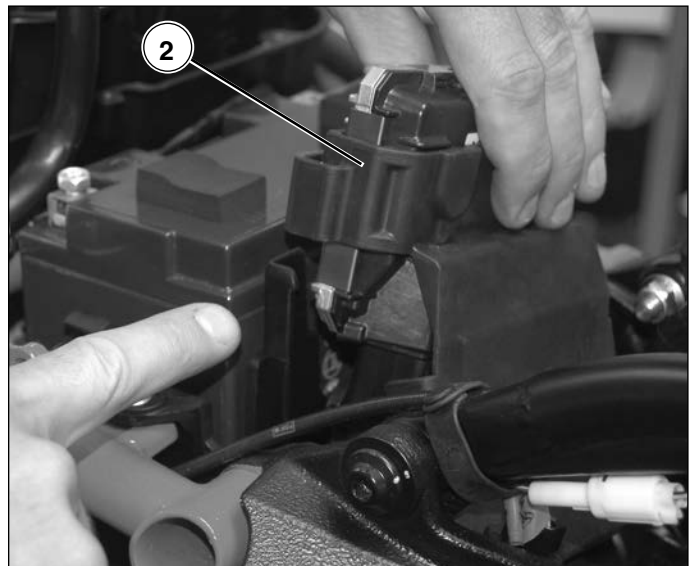



Bodywork

Unhook the 2 ECU unit connectors (3) by pushing the button and turning the bayonet connector.

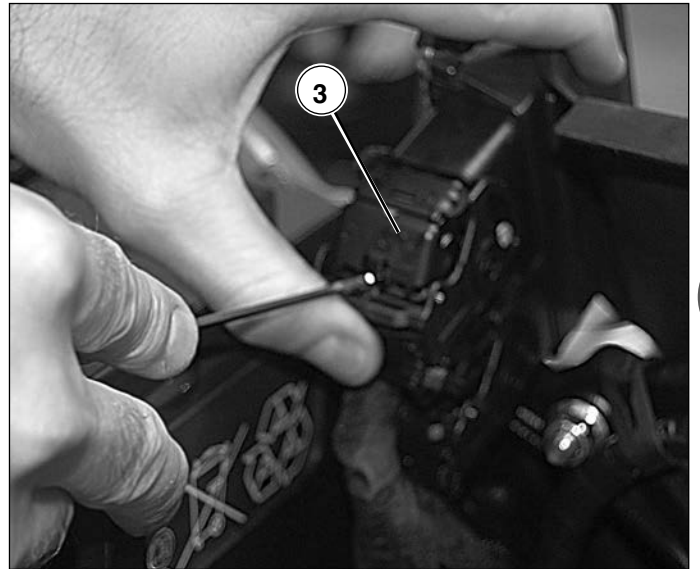

Remove the air filter (4).



Unhook the oil vapour tube.



C



Bodywork

Remove the two internal screws (5) that hold the air box to the valve cover.

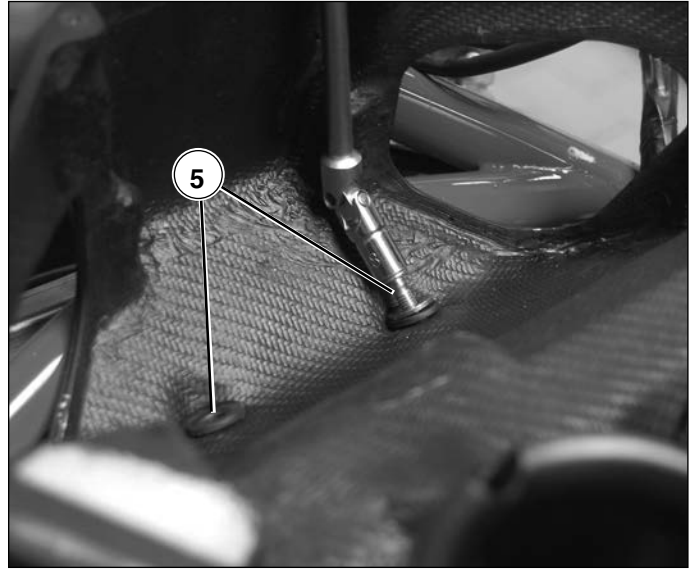

Lift and remove the airbox.

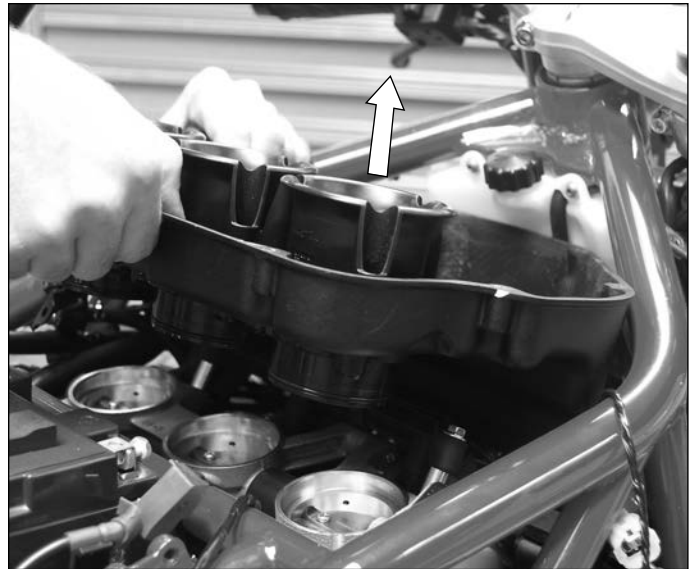



Bodywork

MUDGUARD - CENTRAL CONVEYOR - RADIATOR PROTECTION

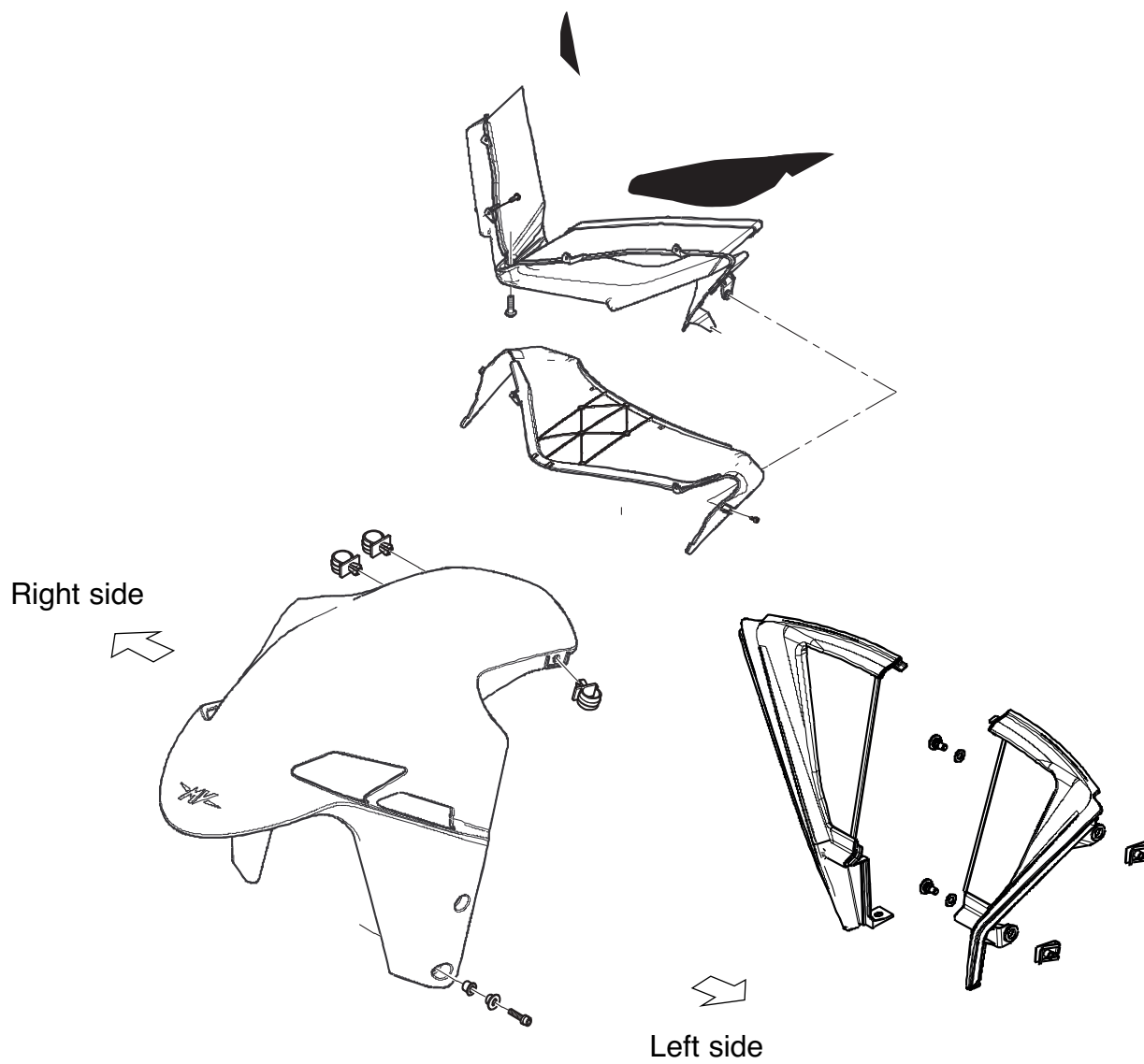

C

Central manifold disassembly

Slide off the two horn fastons (1).

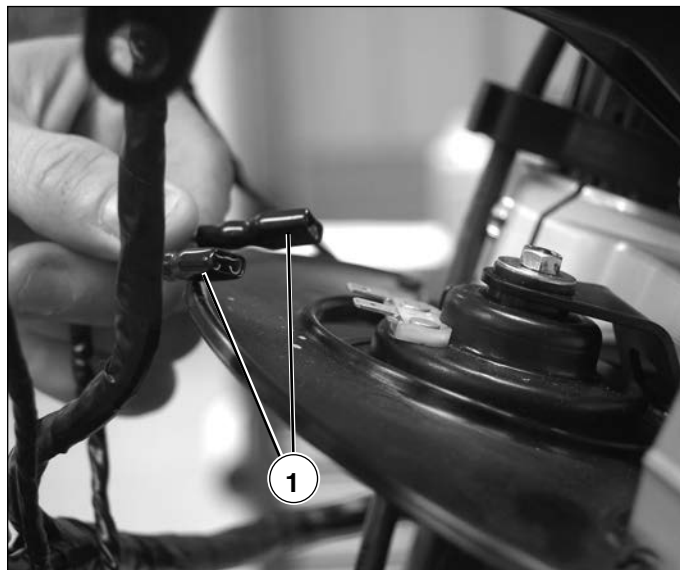

Remove the two clamping screws (2) and take out the central conveyor (3) removing the claxon as well (5).

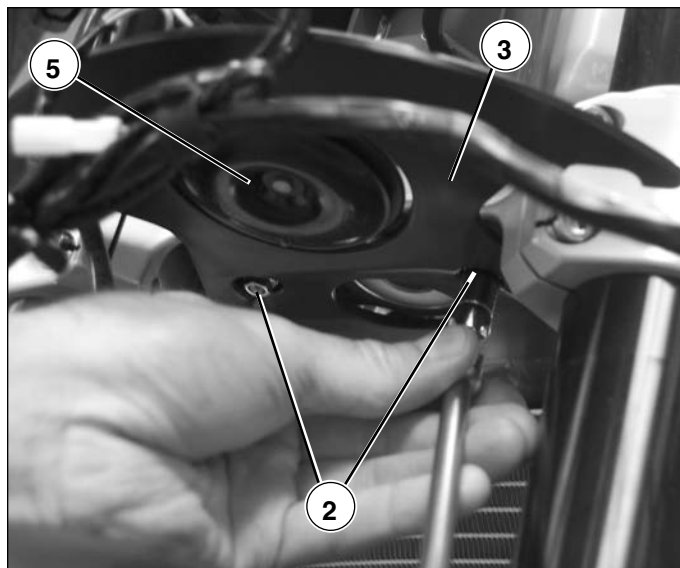

Front mudguard disassembly

Unscrew and remove the 4 fixing screws (1) on the mudguard (2 per side).

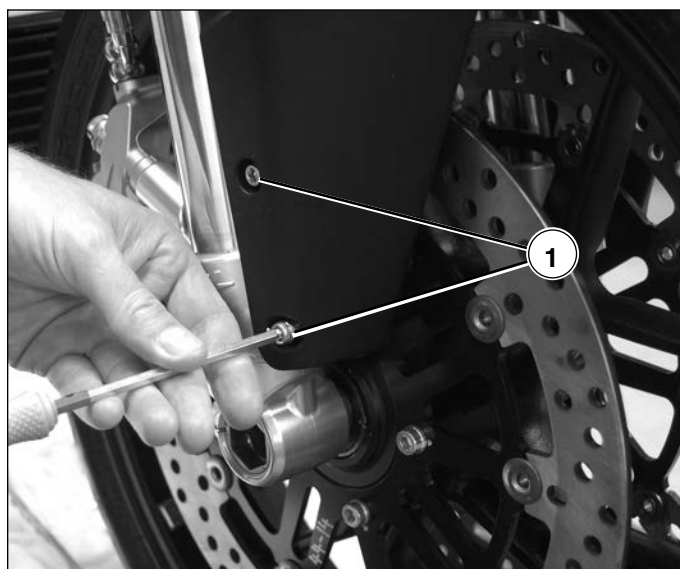

Release the brake pipes from the three clamps (2), two on the right side and one on the left side.

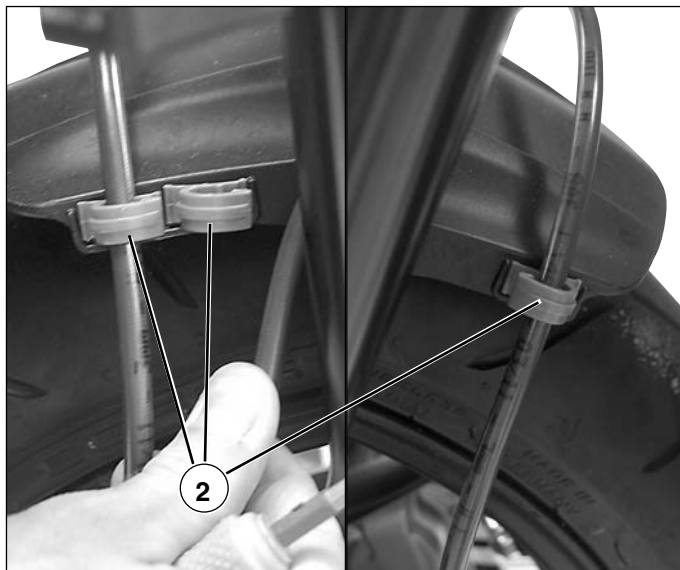

Slide the mudguard off of the front being careful of the pipe gland clamps.



Oil radiator protection disassembly

The two halves of the oil radiator guard are removed from the motorcycle when the fairing side panels are taken off of the motorcycle. To remove the rh radiator guard from the fairing side panel, do the following:

- Remove the two screws (1) that secure the rh guard.

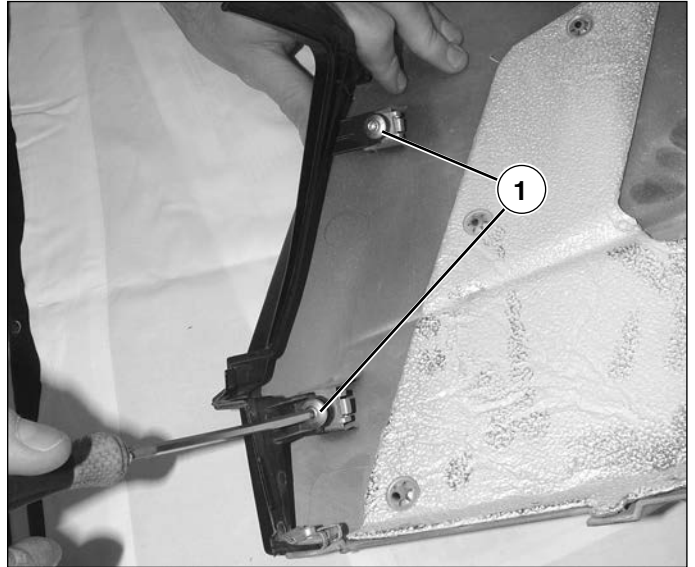

- Remove the rh guard (2) from the fairing side panel.

Do the same to dismantle the lh guard.

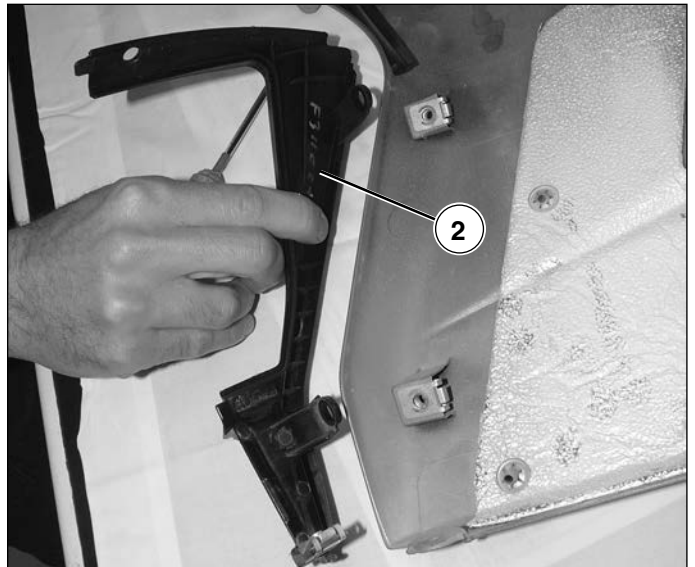



Air intake injection system

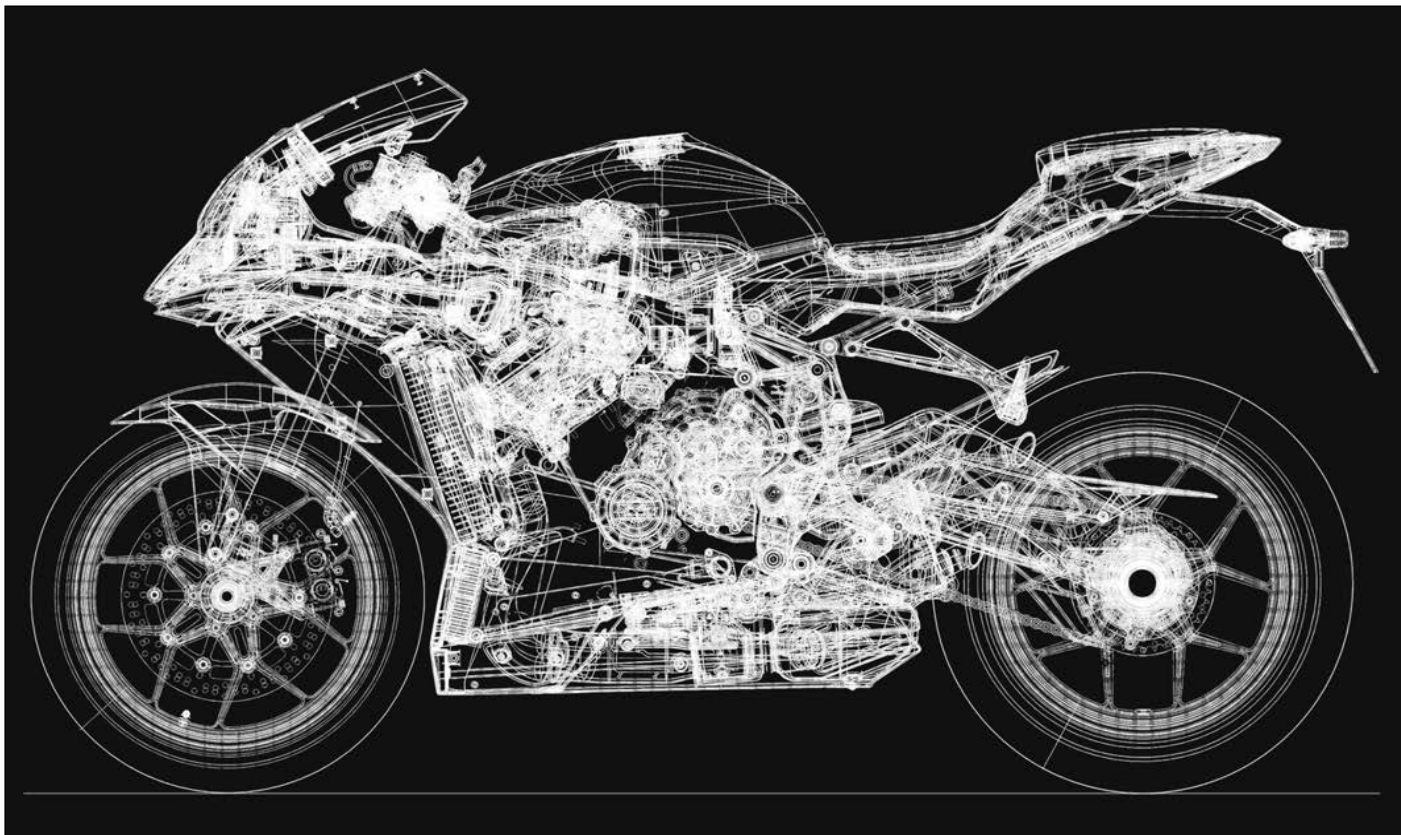

D

SECTION D
Revision 0



Air intake injection system

SUMMARY

INJECTION SYSTEM TECHNICAL CHARACTERISTICS	PAGE 3
INJECTION TIME COMPENSATION (VOLUME)	PAGE 4
INJECTION ARREST CONTROL	PAGE 4
FUEL FEED SYSTEM	PAGE 5
FUEL PRESSURE ADJUSTER	PAGE 6
FUEL INJECTOR	PAGE 6
FUEL PUMP CONTROL SYSTEM	PAGE 7
ECU (ELECTRONIC CONTROL UNIT)	PAGE 8
SENSORS	PAGE 8
ATMOSPHERIC AIR TEMPERATURE SENSOR	PAGE 8
THROTTLE BODY POSITION SENSOR	PAGE 10
INJECTOR CONTROL	PAGE 11
FUEL PUMP CONTROL	PAGE 11
ACTUATORS	PAGE 13
DIAGNOSTICS SYSTEM	PAGE 14
AIR INTAKE SYSTEM TECHNICAL CHARACTERISTICS	PAGE 15
POSITIONS OF ENGINE-CONTROL SYSTEM PARTS	PAGE 16
INJECTION SYSTEM ELECTRICAL DIAGRAM	PAGE 17
ENGINE CONTROL UNIT PINOUT	PAGE 18



Air intake injection system

INJECTION SYSTEM TECHNICAL CHARACTERISTICS

INJECTION TIME (INJECTION VOLUME)

The factors for the determination of the injection time are the basic injection time that is calculated on the basis of the r.p.m., the pressure of the intake duct and various compensations that are determined according to signals coming from various sensors that reveal the condition of the engine and the riding conditions.

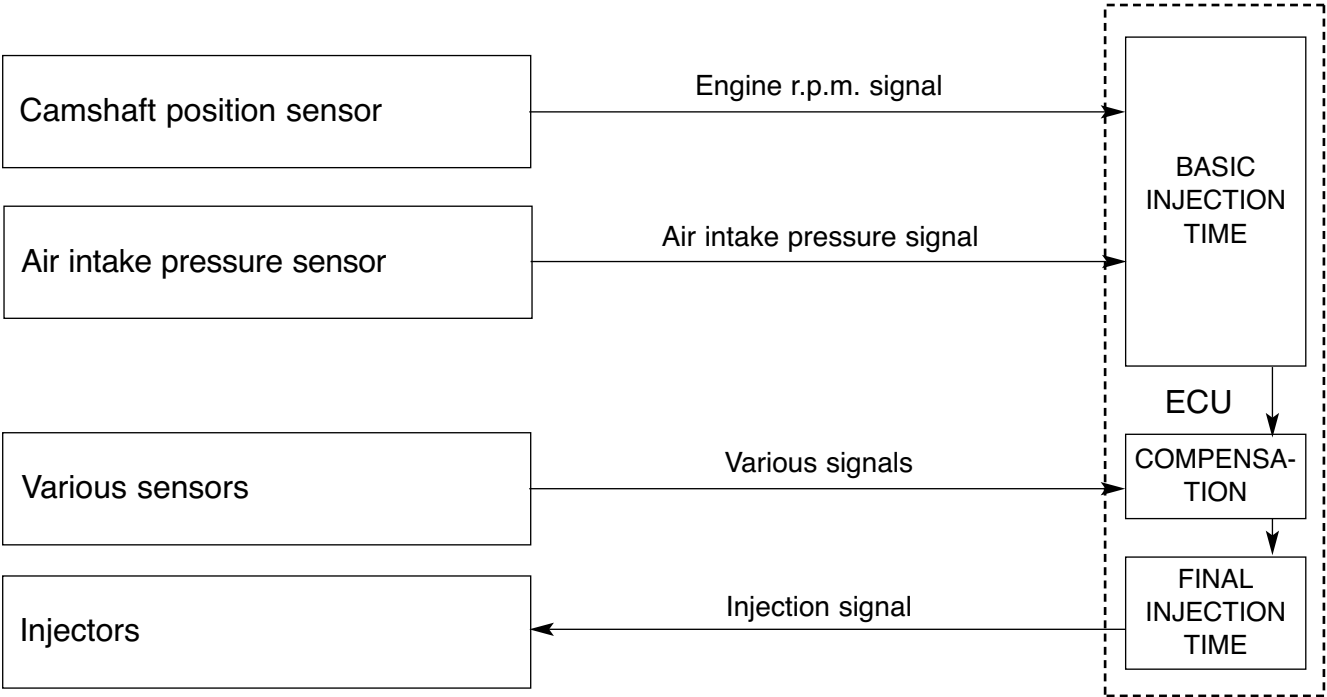

D



Air intake injection system

INJECTION TIME COMPENSATION (VOLUME)

The various sensors allow the injection time (volume) compensations to be carried out on the basis of the following signals.

SIGNAL	DESCRIPTION
ATMOSPHERIC PRESSURE SENSOR SIGNAL	When the atmospheric pressure is low, the sensor sends a signal to the ECU to reduce the injection time (volume). In the starting phase the same sensor is used to adjust the timing between the injection and the spark in the 3 cylinder banks.
ENGINE COOLANT TEMPERATURE SENSOR SIGNAL	When the temperature of the engine coolant is low, the injection time (volume) is increased.
AIR INTAKE TEMPERATURE SENSOR SIGNAL	When the temperature of the intake air is low, the injection time (volume) is increased.
BATTERY VOLTAGE SIGNAL	The voltage of the battery is supplied to the ECU for the functioning of the ECU and this voltage is revealed and utilised as a signal for the compensation of the injection time (volume). A low voltage determines a longer injection time for the adjustment of the volume of the injection.
STARTER SIGNAL	When the engine is switched on, a greater volume of fuel is injected during the starting period.
ACCELERATION/DECELERATION SIGNAL	During acceleration, the injection time of the fuel (volume) is increased in proportion to the opening of the accelerator and the r.p.m. of the engine. During deceleration, the injection of fuel is diminished in proportion to the speed of closure of the accelerator handgrip and of the engine r.p.m.

INJECTION ARREST CONTROL

SIGNAL	DESCRIPTION
R.P.M. LIMITER SIGNAL	The functioning of the fuel injectors is interrupted when the level of engine r.p.m. reaches its limit. The r.p.m. limiter interrupts the ignition system and the interruption signal of the ignition is therefore sent to the ECU.
ENGINE CUT-OFF SIGNAL	The ECU stops fuel injector operation in the deceleration phase when the gas potentiometer reaches zero and the torque value falls below a given threshold. The injectors turn back on again when a given engine rpm threshold is reached.



Air intake injection system

FUEL FEED SYSTEM

The fuel feed system consists of the tank, pump, filter, feed tube, feed tubes (including the fuel injectors) and the regulator of the pressure. The fuel in the tank is pumped into the feed tubing at a controlled pressure by the relative regulator and maintained at a certain constant value higher than the suction generated by the motor. The fuel is injected into the air intake conduit when the injector opens, following a law generated by the ECU.

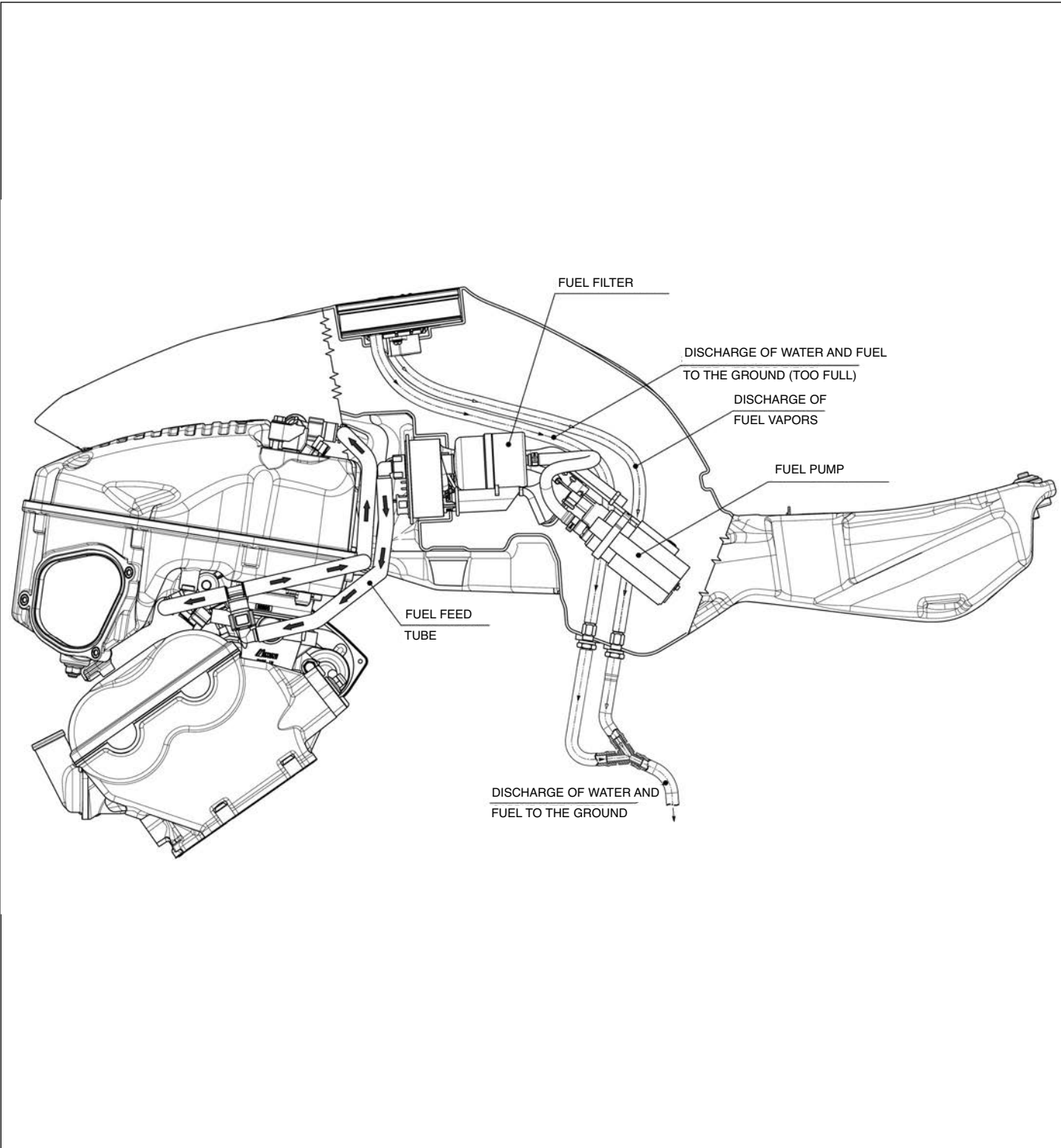

D



Air intake injection system

FUEL PRESSURE REGULATOR

The fuel pressure regulator is a diaphragm pressure release valve that consists of a diaphragm, spring and valve. It always maintains the pressure of the fuel sent to the injector at 3,5 kg/cm² (350 kPa). When the pressure of the fuel rises above 3,5 kg/cm² (350 kPa) the excess fuel opens the valve of the regulator and therefore can return to the fuel tank.

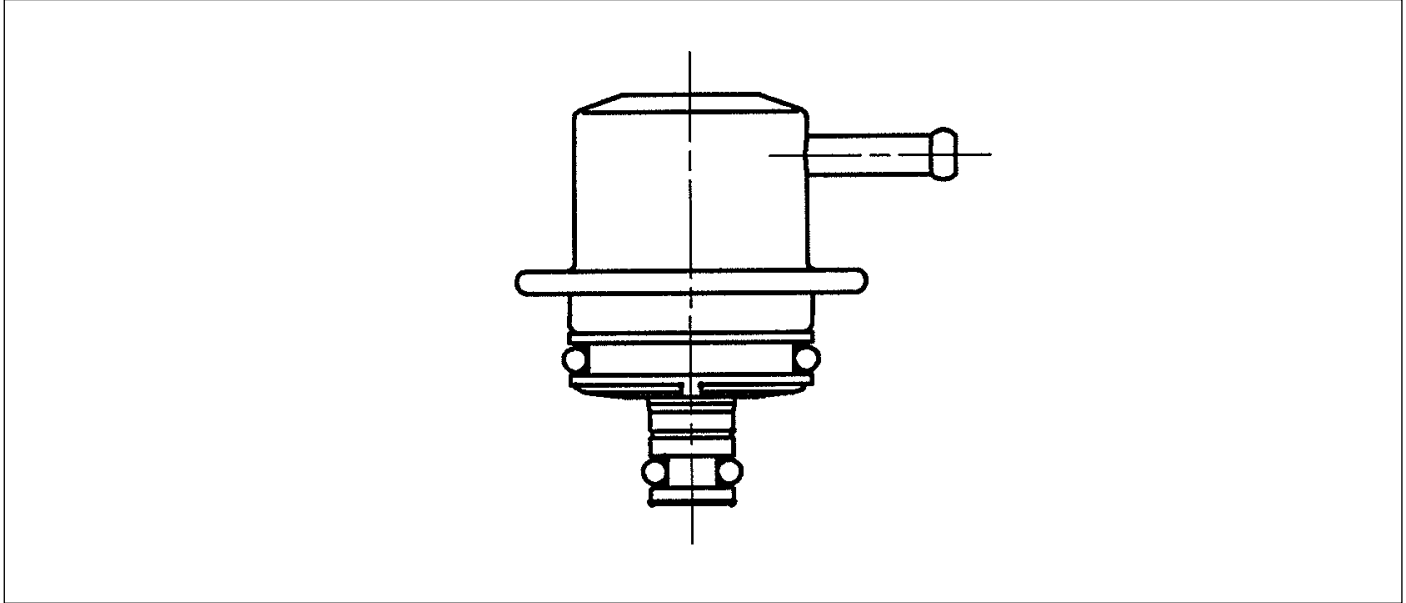

FUEL INJECTOR

The fuel injector consists of a solenoid, piston, needle valve and a filter. The injector is a small electromagnetic injection nozzle that injects fuel into the carburettor according to the signal coming from the ECU. When the solenoid is agitated by the ECU, it becomes an electromagnet and attracts the piston. At the same time, the needle valve incorporated in the piston opens and the injector, under pressure of the fuel, injects the fuel in a conical dispersion. Given that the opening of the needle valve is constant, the volume of fuel injected at any one time is dependent on the time that the solenoid is agitated (injection time).

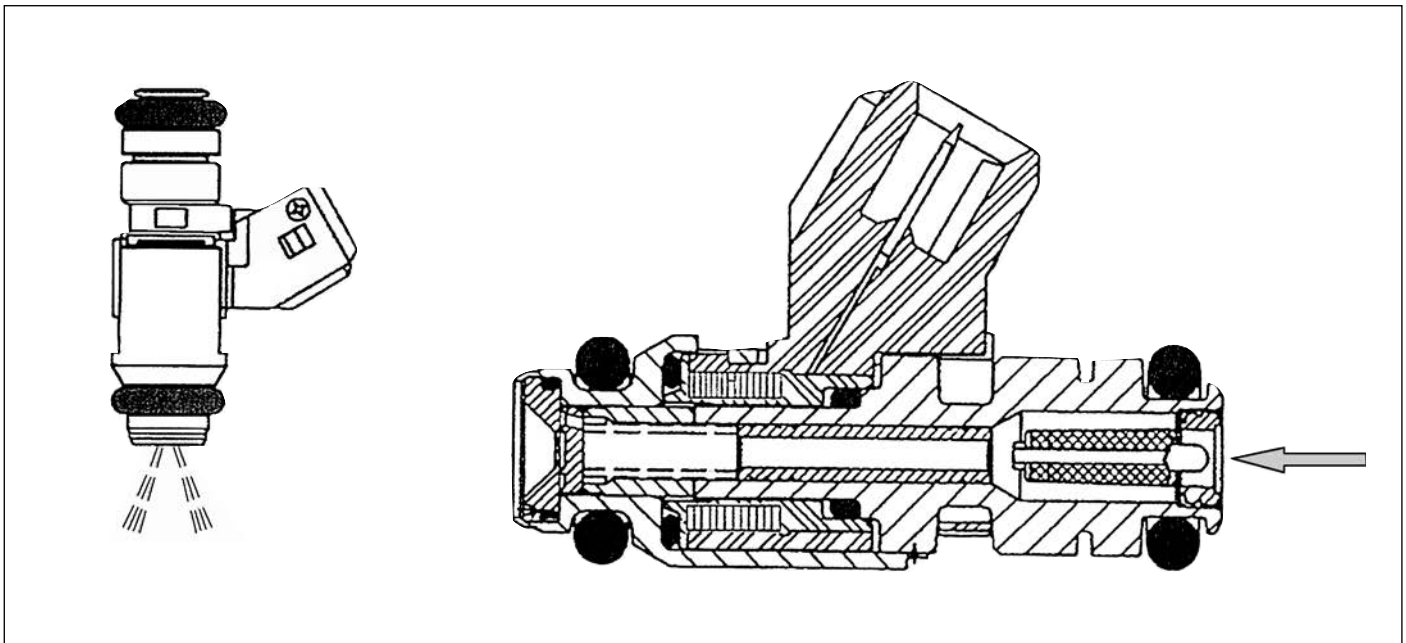



Air intake injection system

FUEL PUMP CONTROL SYSTEM

When the ignition switch is turned to the ON position, the fuel pump motor is started by the current supplied by the battery.

As the CPU possesses a timer function, the pump motor stops turning three seconds after the ignition switch has been brought to the "ON" position. If the starter motor turns the electric motor shaft during or after the three seconds, the motor rotation signal is sent to the CPU that, by controlling the pump relay, makes the pump motor function continuously.

When the ignition switch is switched to the "OFF" position, the control of the pump relay is interrupted and contemporaneously also the control of the injectors and the ignition coils, thereby causing the engine to switch off.

D

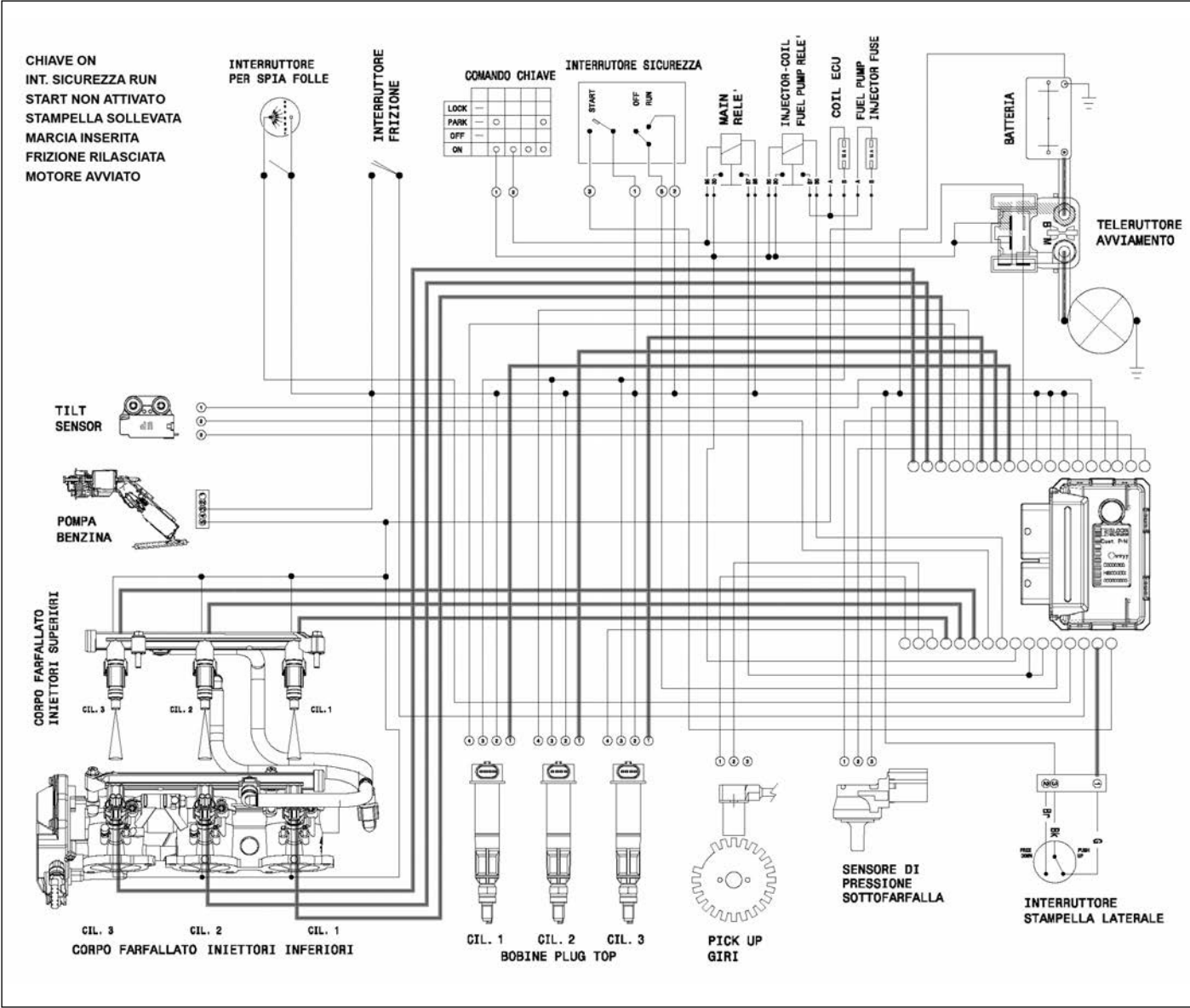



Air intake injection system

ECU

The ECU is situated under the tank behind the battery. The ECU consists of a CPU (Central Processing Unit), a memory unit and I/O sections (input/output). The signal of each individual sensor is sent to the input section and then to the CPU. On the basis of the signals received, the ECU calculates the volume of fuel and the ignition advance necessary by utilising prepared schemes for the various conditions of the engine and sending them respectively to the injectors and the ignition coils.



SENSORS

ATMOSPHERIC AIR TEMPERATURE SENSOR

The suction air sensor (1) is on the front of the filter box cover and provides the value of the air temperature.

Check

Connect the connector and measure the resistance value between the two contacts on the sensor, which must be $2.5 \text{ k}\Omega \pm 10\%$ at 20°C .



1 INTAKE AIR PRESSURE SENSOR

The sensor (2) reveals the pressure of the intake air and this pressure is therefore converted into voltage that is sent to the ECU.

The signal involved has a double purpose, one being that of phasing the injection and ignition of the cylinders and the second being that of adjusting the base fuel injection time (volume); this is in fact determined depending on the tension of the signal (output tension).

The voltage increases when the pressure of the intake air is high.

The sensor is checked by diagnostic software.

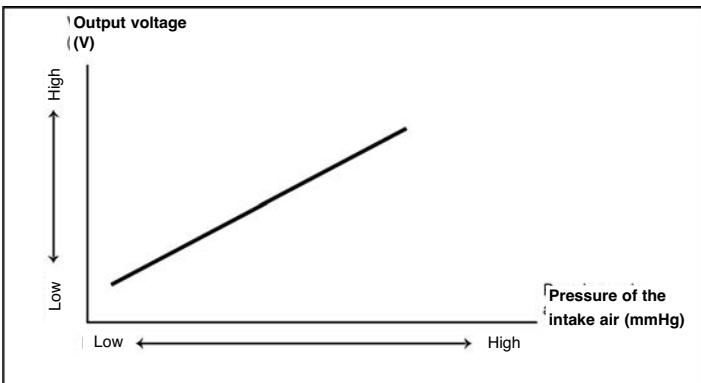
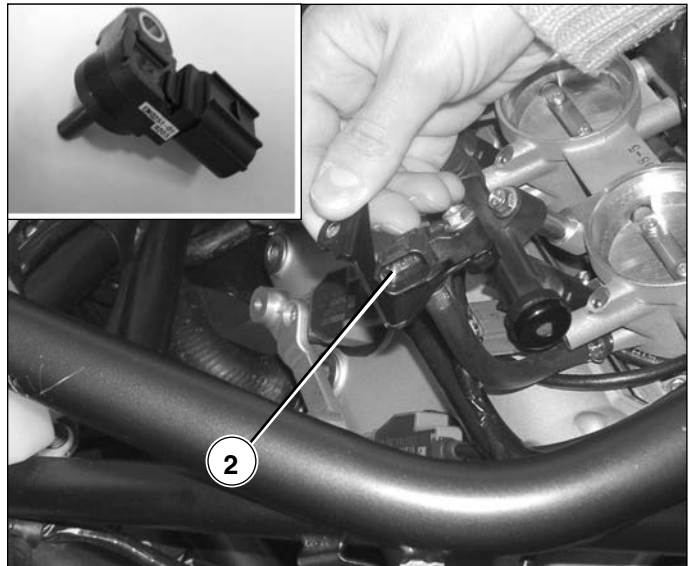



Air intake injection system

2 INTAKE AIR TEMPERATURE SENSOR

The temperature of the intake air is found by converting the resistance of the Thermistor into voltage and then sending it to the ECU. The volume of the injection increases when the air temperature is low.

The resistance of the Thermistor increases when the air temperature is low and diminishes when the temperature is high.

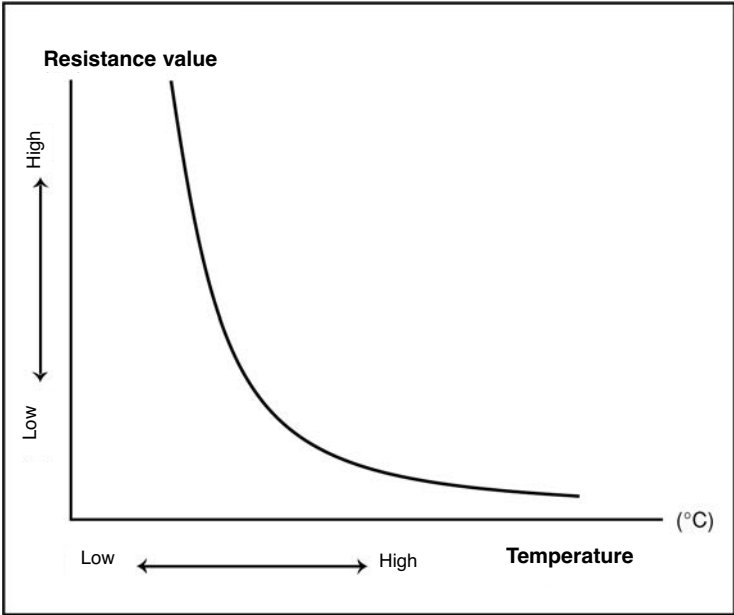

AIR TEMPERATURE A - B

Air temperature sensor characteristics	
Temperature (°C)	Resistance (kΩ)
-10	9,5
0	6
10	3,8
20	2,5
30	1,7
40	1,2
60	0,6

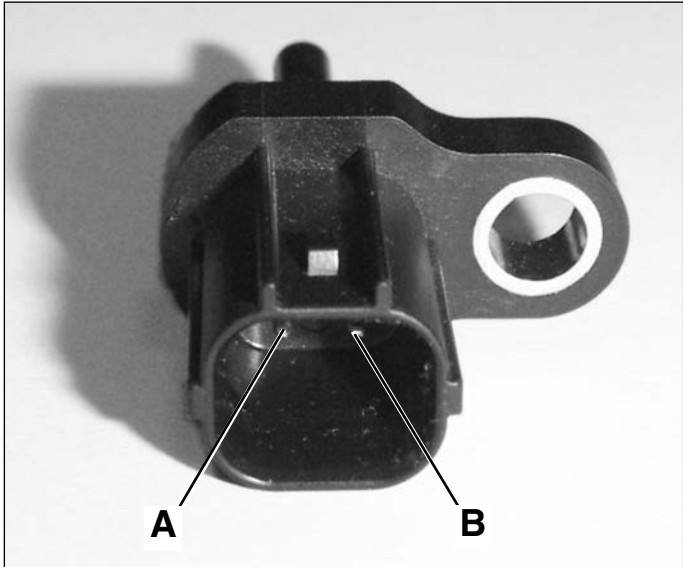

THROTTLE BODY POSITION SENSORS

The throttle position sensors are inside the motor of the throttle body (1).

These sensors are potentiometers with a variable resistance based on the opening angle of the accelerator and operate in a crossed fashion.

The sensors are powered by the ECU at the established voltage of 5V and provide, in output, a voltage proportional to the throttle angle.

The ECU reads the output values of the two sensors and based on the coherence of these values, it determines the throttle opening angle. If the two values are not coherent it will provide a fault alert.

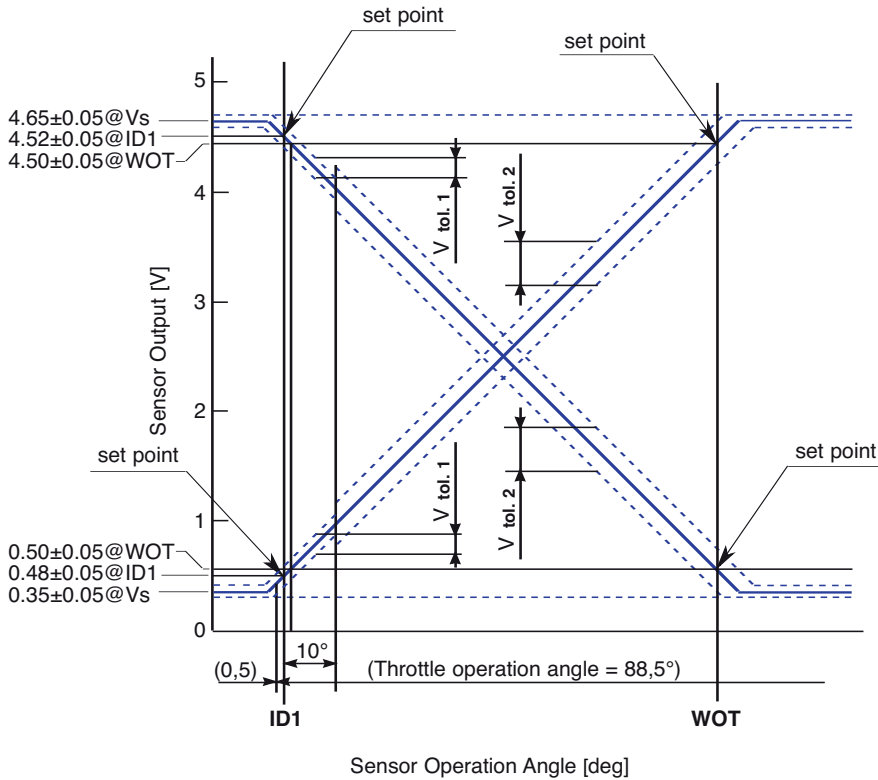
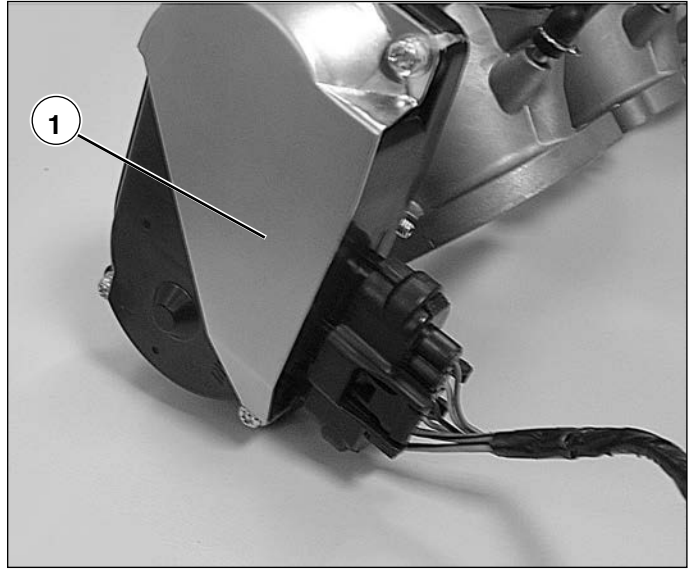

Item		Specification
Output set	PS1	0.50[V]
@ID1	PS2	4.50[V]
Output set	PS1	4.50[V]
@WOT	PS2	0.50[V]
Output clamp	HI	4.65[V]
	LOW	0.35[V]
tolerance due to temperature		±0.05[V]
Linearity	ID1~10[deg]	±0.10[V]
tolerance	10[deg]~WOT	±0.15[V]

The sensor is checked by diagnostic software.



Air intake injection system

INJECTOR CHECK

To check the injectors proceed as follows:

- Disconnect the connector on each injector.
- Proceed with checking the reel of each injector
- The contact must not be open between the two pins of the injector, also, the resistance value must be $11 \text{ Ohm} \pm 10\%$ at 20°C .

Otherwise, proceed with changing the faulty injector.



FUEL PUMP CHECK

Check the condition of the fuel pump fuse.

To check the condition of the fuel pump, proceed as follows:

- After having removed the fuel tank, proceed with the check of continuity between pin 2 and 5 on the connector of the pump as indicated in the figure.



- proceed with checking the level probe operation
- connect pins 3 and 4 of the pump connector and make sure that the resistance value is $2 \text{ kOhm} \pm 10\%$ at 20°C





Air intake injection system

- If the fuel pump unit does not continue to function correctly after the above-described tests, proceed with relative relay control **(1)** on the right side of the motorcycle, identified by a ring marked with "I" located on the cable bundle.

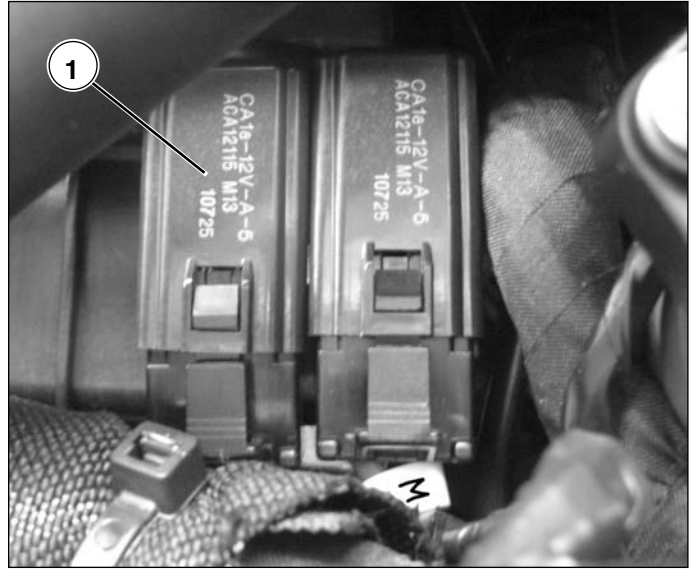

D



Air intake injection system

ACTUATORS

Fuel injector

The fuel injector consists of a solenoid, piston, needle valve and a filter. The injector is a small electromagnetic injection nozzle that injects fuel into the carburettor according to the signal coming from the ECU. When the solenoid is agitated by the ECU, it becomes an electromagnet and attracts the piston. At the same time, the needle valve incorporated in the piston opens and the injector, under pressure of the fuel, injects the fuel in a conical dispersion. Given that the opening of the needle valve is constant, the volume of fuel injected at any one time is dependent on the time that the solenoid is agitated (injection time).

TECHNICAL DATA: Winding resistance 12 Ω

D

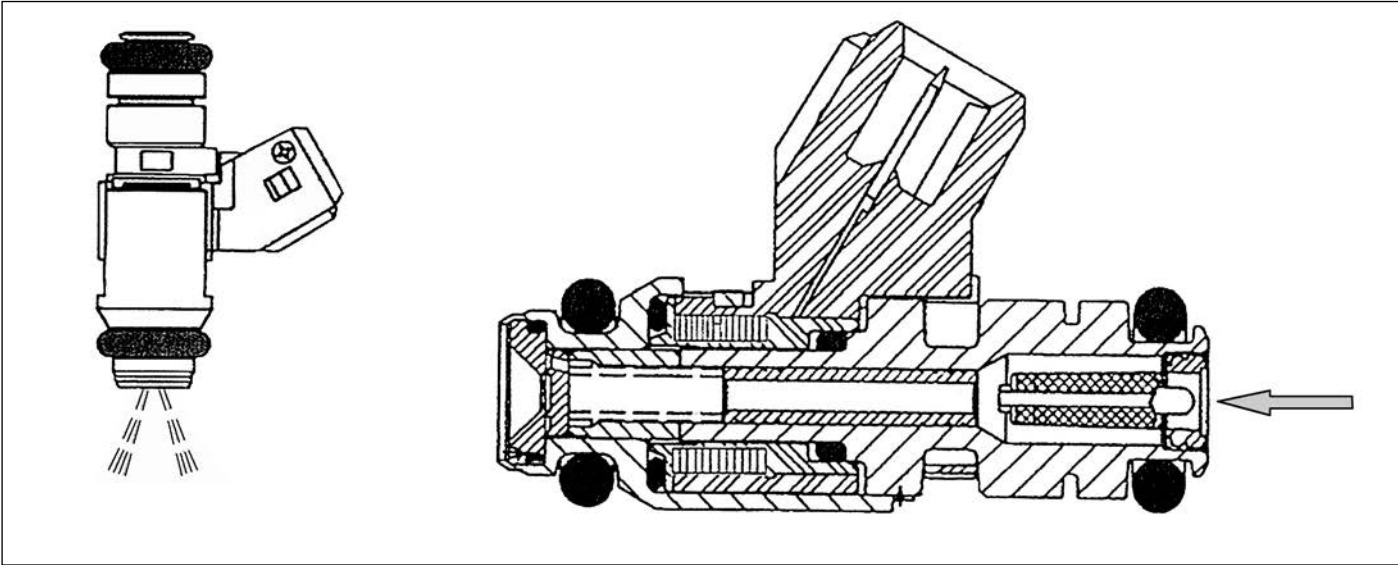

Ignition coils

The ignition coils are of the top plug type (they are assembled directly on the spark plugs. This avoids the use of the HT leads and enhance the overall system reliability..

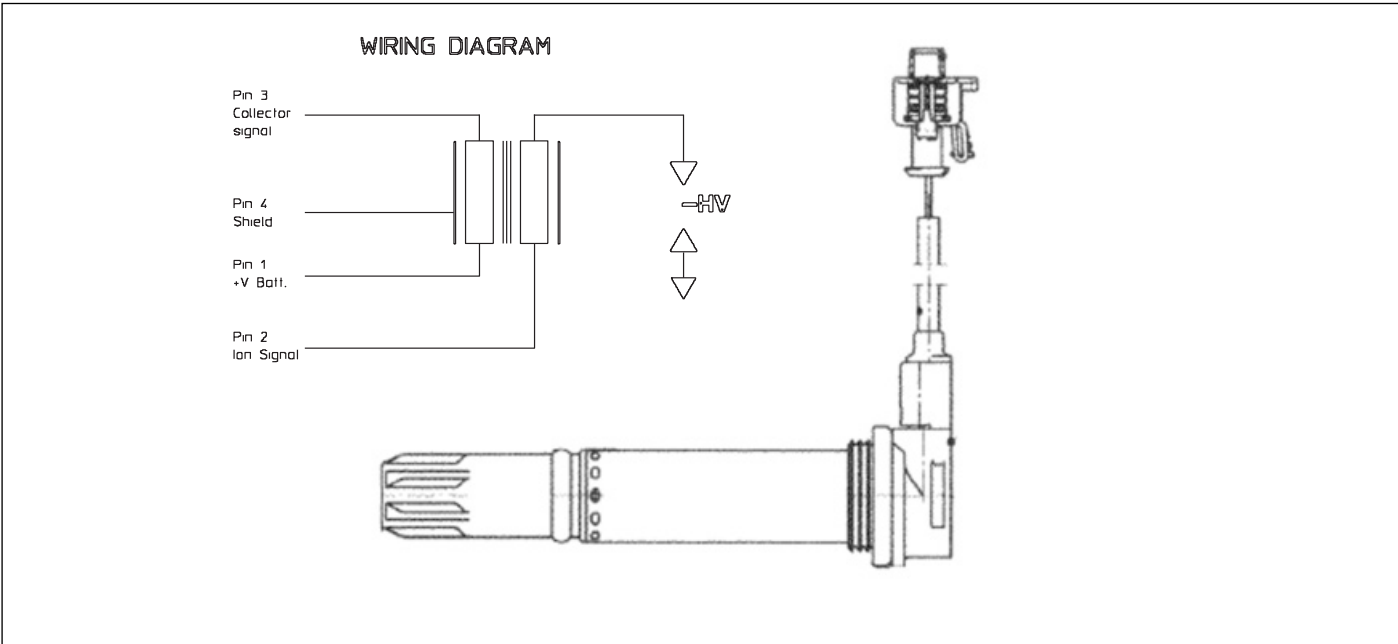



Air intake injection system

DIAGNOSTICS SYSTEM

Ignition and injection system diagnostics

For the diagnosis of the ignition and injection system a TEXA diagnostic software is available which is capable of identifying and recording the faults present or that were present previously on the motorcycle. This software is equipped with a guide book for the use of the software itself to carry out checks on each individual component of the system.

D



The IDC4 software allows to carry out the following operations:

- reading of engine parameters
- reading of faults and their deletion
- active diagnosis





Air intake injection system

AIR INTAKE SYSTEM TECHNICAL CHARACTERISTICS

This motorcycle utilises direct induction in the air intake system. The frontal pressure of the air during normal riding conditions is conducted to the air filter compartment in such a way that the incoming air is pressurised thereby improving the air intake efficiency to obtain greater power from the engine.

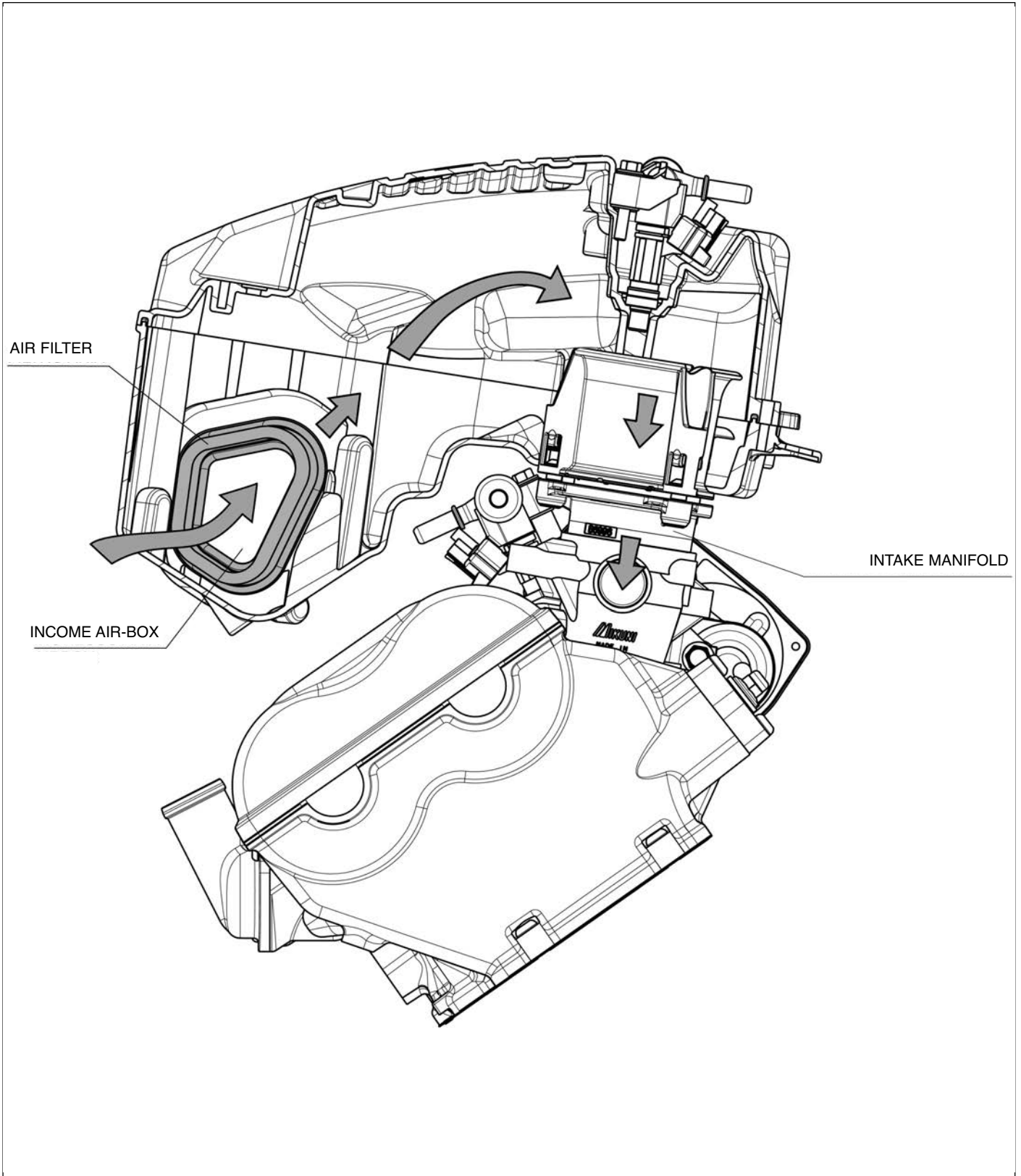

D



Air intake injection system

POSITIONS OF ENGINE-CONTROL SYSTEM PARTS

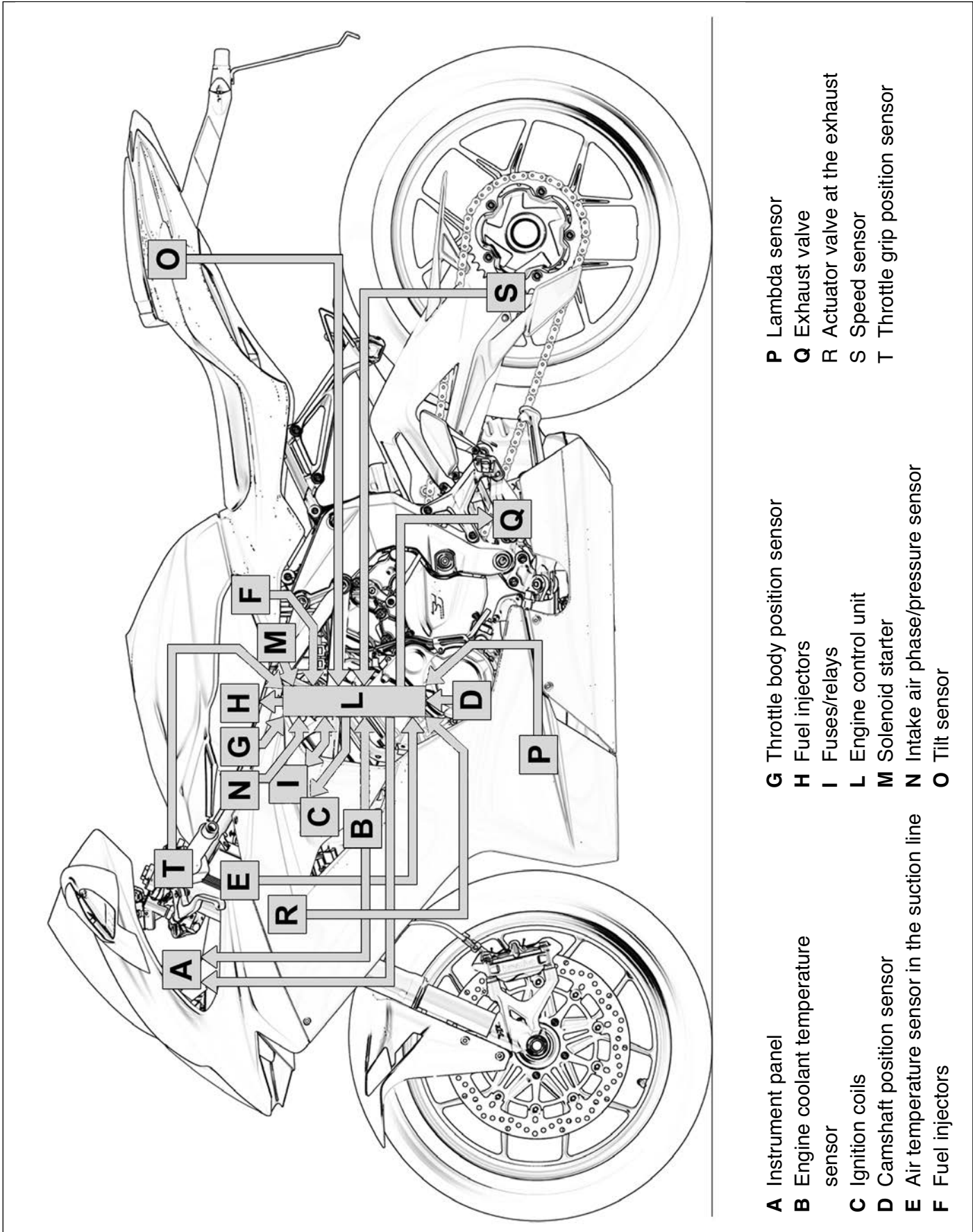

D

- | | | |
|--|---|--|
| <p>A Instrument panel</p> <p>B Engine coolant temperature sensor</p> <p>C Ignition coils</p> <p>D Camshaft position sensor</p> <p>E Air temperature sensor in the suction line</p> <p>F Fuel injectors</p> | <p>G Throttle body position sensor</p> <p>H Fuel injectors</p> <p>I Fuses/relays</p> <p>L Engine control unit</p> <p>M Solenoid starter</p> <p>N Intake air phase/pressure sensor</p> <p>O Tilt sensor</p> | <p>P Lambda sensor</p> <p>Q Exhaust valve</p> <p>R Actuator valve at the exhaust</p> <p>S Speed sensor</p> <p>T Throttle grip position sensor</p> |
|--|---|--|



Air intake injection system

INJECTION SYSTEM ELECTRICAL DIAGRAM

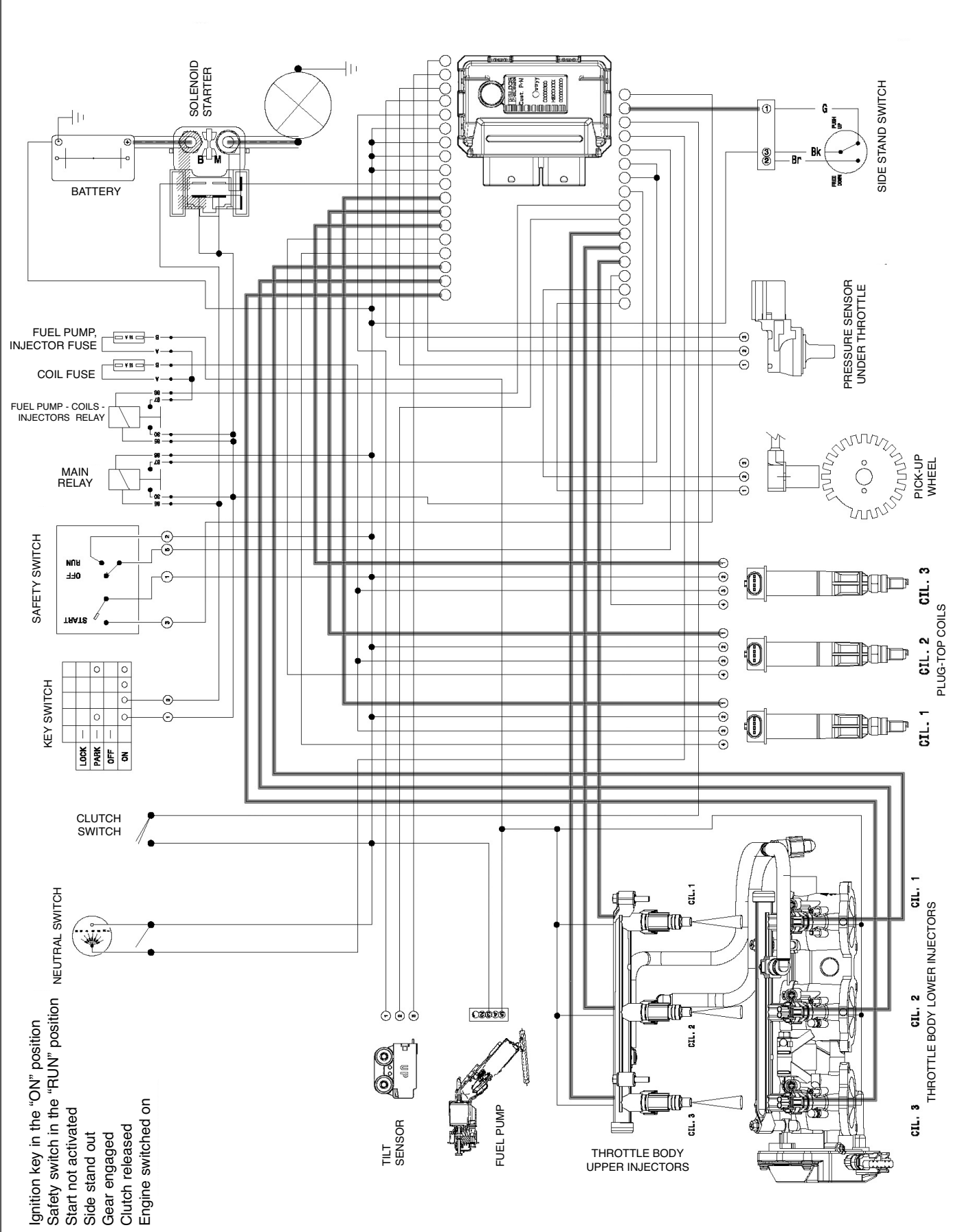

D



Air intake injection system

Engine control unit pinout, MV Agusta F3			Connector	
Pin name	Description of associated function	Type	Vehicle Pin n°	Engine Pin n°
IN_REL+	INPUT CRANKSHAFT POSITION SENSOR +	VRS interface		A1
IN_REL-	INPUT CRANKSHAFT POSITION SENSOR -	VRS interface		A2
IN_CAMSHAFT		Pull Up (Vcc)		A3
IN_GEAR_POS	INPUT ANALOGIC SENSOR GEAR	Pull Up (Vcc)		A4
IN_THROTTLE_POS_1A	THROTTLE BODY THROTTLE POSITION INPUT (TPS)	Pull Up (Vcc)		B1
IN_THROTTLE_POS_2A	THROTTLE BODY THROTTLE POSITION INPUT (TPS)	Pull down		B2
IN_THROTTLE_POS_1B		Pull Up (Vcc)		B3
IN_THROTTLE_POS_2B		Pull down		B4
IN_LAMBDA_1	INPUT LAMBDA SENSOR (-) N°1	Pull down + Pull Up (Vcc)		C1
IN_LAMBDA_2		Pull down + Pull Up (Vcc)		C2
IN_INTAKE_PRES_1	INPUT SENSOR OF AIR PRESSURE COLLECTOR/BAROMETRIC	Pull down		C3
IN_INTAKE_PRES_2		Pull down		C4
IN_WATER_TEMP	INPUT WATER TEMPERATURE SENSOR SIGNAL	Pull Up (Vcc)		D1
IN_AIR_TEMP	INPUT AIR TEMPERATURE SENSOR SIGNAL	Pull Up (Vcc)		D2
IN_TSS_FKB	RADIATOR WATER TEMPERATURE SENSOR INPUT	Pull down		D3
IN_EXHAUST_FBK	INPUT EXHAUST VALVE ACTUATOR	Pull down		D4
IN_SEC_CURRENT	INPUT ION CURRENT COIL 1	ION Current interface		E1
IN_SEC_CURRENT	INPUT ION CURRENT COIL 2	ION Current interface		E2
IN_SEC_CURRENT	INPUT ION CURRENT COIL 3	ION Current interface		E3
IN_SEC_CURRENT		ION Current interface		E4
OUT_INJECTOR_1A	OUTPUT INJECTOR CONTROL 1 HIGH INJECTORS	Low side		F1
OUT_INJECTOR_2A	OUTPUT INJECTOR CONTROL 2 HIGH INJECTORS	Low side		F2
OUT_INJECTOR_3A	OUTPUT INJECTOR CONTROL 3 HIGH INJECTORS	Low side		F3
OUT_INJECTOR_4A		Low side		F4
OUT_INJECTOR_1B	OUTPUT INJECTOR CONTROL 1 LOW INJECTORS	Low side		G1
OUT_INJECTOR_2B	OUTPUT INJECTOR CONTROL 2 LOW INJECTORS	Low side		G2
OUT_INJECTOR_3B	OUTPUT INJECTOR CONTROL 3 LOW INJECTORS	Low side		G3
OUT_INJECTOR_4B		Low side		G4
OUT_H_LAMBDA_1	OUTPUT LAMBDA HEATER PWM CONTROL	Low side		H1
OUT_H_LAMBDA_2		Low side		H2
OUT_VVT_VALVE		Low side		H3
GND Analog	ANALOGIC MASS 1	Sensor Ground		H4
GND Analog	ANALOGIC MASS 2	Sensor Ground		J1
GND Analog	ANALOGIC MASS 3	Sensor Ground		J2
GND Analog	ANALOGIC MASS 4	Sensor Ground		J3
GND Analog	ANALOGIC MASS 5	Sensor Ground		J4
VREF_1	OUTPUT VREF1 +5V, FOR TPS	5V Sensor Supply		K1
VREF_1	OUTPUT VREF1 +5V, FOR EXHAUST VALVE ACTUATOR	5V Sensor Supply		K2
VREF_2	VREF2 +5V, OUTPUT, FOR ATMOSPHERIC PRESSURE SENSOR	5V Sensor Supply		K3
VREF_2		5V Sensor Supply		K4
OUT_BRIDGE_A1	OUTPUT TPS ENGINE DC POSITIVE CONTROL	H-Bridge		L1
OUT_BRIDGE_A2	OUTPUT COMMAND + DCM EXHAUST BUTTERFLY VALVE	H-Bridge		L2
OUT_IGN_COIL_1	OUTPUT COIL CONTROL N° 1	Low side		L3
OUT_IGN_COIL_2	OUTPUT COIL CONTROL N° 2	Low side		L4
OUT_BRIDGE_B1	OUTPUT TPS ENGINE DC NEGATIVE CONTROL	H-Bridge		M1
OUT_BRIDGE_B2	OUTPUT COMMAND- DCM EXHAUST BUTTERFLY VALVE	H-Bridge		M2
OUT_IGN_COIL_4		Low side		M3
OUT_IGN_COIL_3	OUTPUT COIL CONTROL N° 3	Low side		M4
IN_SPD_FRONTW	INPUT FRONT WHEEL SPEED HALL SENSOR	Pull Up (Vcc)	A1	
IN_SPD_REARW	INPUT REAR WHEEL SPEED HALL SENSOR	Pull Up (Vcc)	A2	
IN_START_SW	INPUT SWITCH "START ENGINE"	Pull down	A3	
IN_SIDE_STAND	INPUT SWITCH SIDE-STAND	Pull down	A4	
IN_CLUTCH_SW	INPUT CLUTCH SENSOR SWITCH	Pull down	B1	
IN_RUN_STOP	INPUT SWITCH "ENGINE STOP"	Pull down	B2	
IN_TIP_OVER	INPUT TILT SWITCH SENSOR	Pull down + Pull Up (Vcc)	B3	
IN_GAS_POS_1	INPUT GRIP POSITION SENSOR 1	Pull down	B4	
IN_GAS_POS_2	INPUT GRIP POSITION SENSOR 2	Pull Up (Vcc)	C1	
OUT_PUMP_RELAY	OUTPUT FUEL PUMP RELAY CONTROL	Low side	C2	



Air intake injection system

Engine control unit pinout, MV Agusta F3			Connector	
Pin name	Description of associated function	Type	Vehicle Pin n°	Engine Pin n°
OUT_LOW_BEAM	OUTPUT LOW BEAM LIGHT RELAY MANAGEMENT CONTROL	Low side	C3	
OUT_FAN_RELAY_1	OUTPUT ELECTRIC FAN RELAY MANAGEMENT CONTROL 1	Low side	C4	
OUT_FAN_RELAY_2	OUTPUT ELECTRIC FAN RELAY MANAGEMENT CONTROL 2	Low side	D1	
GND Analog		Sensor Ground	D2	
OUT_WARNING_LAMP		Low side	D3	
MAIN_SWITCH_(KL15)	INPUT DASHBOARD KEY SWITCH	Pull down	D4	
GND Analog	ANALOGIC MASS 6	Sensor Ground	E1	
GND Analog	ANALOGIC MASS 7	Sensor Ground	E2	
VREF_1	OUTPUT VREF1 +5V, FOR GRIP POSITION SENSOR 1	5V Sensor Supply	E3	
VREF_2	OUTPUT VREF1 +5V, FOR GRIP POSITION SENSOR 2	5V Sensor Supply	E4	
VREF_1		5V Sensor Supply	F1	
COMM_K_LINE		K-line interface	F2	
COMM_CAN_H1	CAN Line H (HIGH SPEED)	CAN transceiver		
COMM_CAN_L1	CAN Line L (HIGH SPEED)	CAN transceiver	F4	
OUT_AIRCUT_VALVE		Low side	G1	
OUT_CANISTER		Low side	G2	
OUT_TSS		Low side	G3	
OUT_STARTER_RELAY	OUTPUT DIRECT COMMAND REMOTE CONTROL SOLENOID STARTER	Low side	G4	
OUT_REAR_STOP	OUTPUT STOP LIGHT CONTROL	High side	H1	
POWER_BATTERY_(KL30)	DIRECT POWER SUPPLY TO CONTROL UNIT	ECU Supply	H2	
Gnd Power (KL31)	MASS POWER	ECU Power Ground		
Gnd Power (KL31)	MASS POWER	ECU Power Ground	H4	





Air intake injection system

D



Electrical system

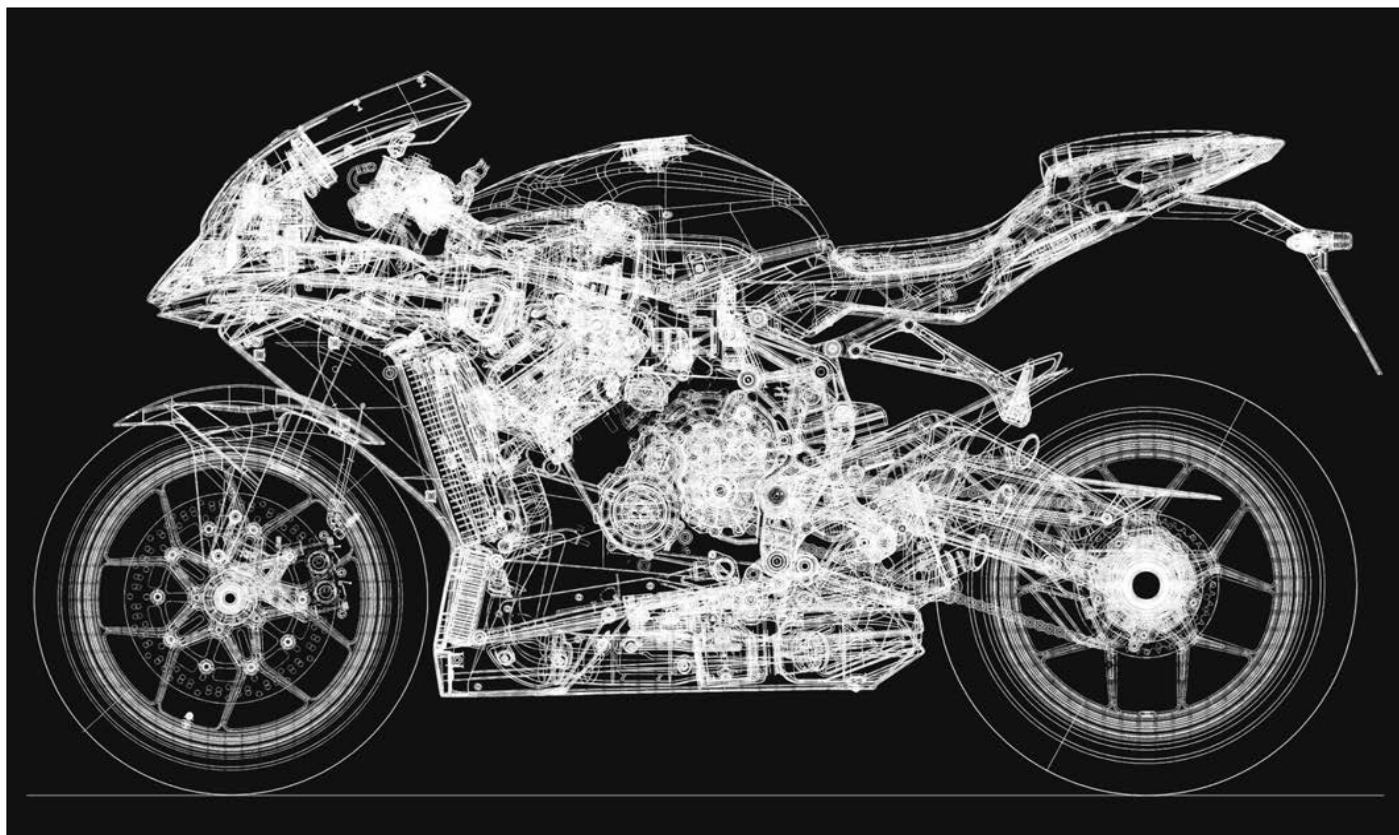

E

SECTION E
Revision 0



Electrical system

SUMMARY

CONNECTORS	PAGE 3
COUPLINGS	PAGE 3
FUSES.....	PAGE 3
SEMICONDUCTOR PARTS	PAGE 4
ELECTRICAL DIAGRAM F3 675 - F3 ORO	PAGE 5
PARTS LIST	PAGE 6
BATTERY	PAGE 7
CHARGING THE BATTERY	PAGE 8
REMOVAL OF THE BATTERY.....	PAGE 9
RECHARGING SYSTEM.....	PAGE 10
EFFICIENCY CHECK.....	PAGE 12
STARTER SYSTEM	PAGE 13
CHECKING THE GENERATOR.....	PAGE 17
STARTER MOTOR REMOVAL	PAGE 18
STARTER MOTOR CHECK	PAGE 19
STARTER MOTOR ASSEMBLY	PAGE 19
STARTER RELAY CHECK.....	PAGE 19
TILT SENSOR	PAGE 20
GEAR POSITION SWITCH.....	PAGE 21
SIDE STAND SWITCH.....	PAGE 21
FUSES.....	PAGE 22
SPARK PLUGS	PAGE 23
MAIN RELAY.....	PAGE 24
ENGINE PICK-UP	PAGE 25
E. A. S.	PAGE 25
TIMING WHEEL GAP	PAGE 26
RUN-OFF SAFETY SWITCH.....	PAGE 26
INSTRUMENTATION	PAGE 27
OIL PRESSURE SENSOR.....	PAGE 28
FUEL LEVEL WARNING LIGHT SWITCH CHECK.....	PAGE 28
WATER SENSOR	PAGE 29
IGNITION SWITCH.....	PAGE 30
STARTER RELAY CHECK.....	PAGE 30
TURN INDICATORS CHECK	PAGE 30
R.P.M. SENSOR	PAGE 30
SPEED SENSOR.....	PAGE 31
LOW BEAM HEADLIGHT	PAGE 31
HIGH BEAM HEADLIGHT.....	PAGE 32
TURN INDICATORS	PAGE 33
REAR TAIL LIGHTS AND BRAKE LIGHTS	PAGE 33
LICENCE PLATE LIGHT	PAGE 34
ELECTRIC FAN COOLING SYSTEM.....	PAGE 35
HORN	PAGE 36
ECU DISASSEMBLY	PAGE 36
SWITCHES.....	PAGE 37
POSITIONING OF ELECTRICAL SYSTEM WIRE CLAMPS	PAGE 38



Electrical system

CONNECTORS

- When a connector is connected, check that it clicks into position.
- Check the connector for corrosion, dirt or a broken cover.

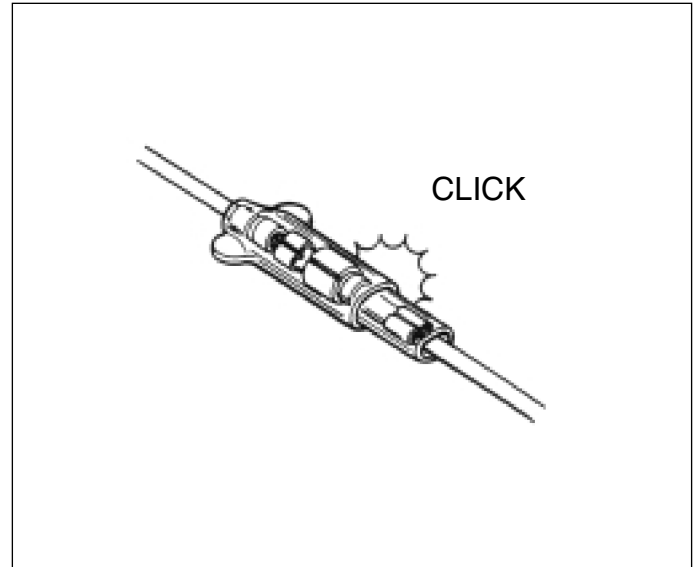

COUPLINGS

- Block couplings – ensure that the block is released before disconnecting it to push it completely home when connecting it.
- When disconnecting a coupling, ensure that the body of the coupling is gripped and do not pull it apart by the leads.
- Check that the terminals of the couplings are not slack or bent.
- Check that the terminals are not corroded or dirty.

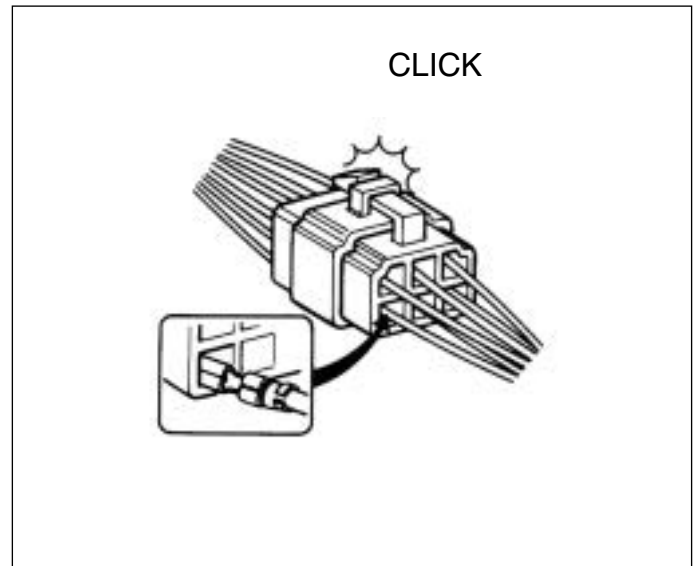

FUSES

- When a fuse burns out, always investigate why the fuse has burnt out. Find the cause, repair and then substitute the fuse.
- Do not utilise a fuse of a different capacity from the original one.
- Do not utilise wire or any other substitute for the fuse.

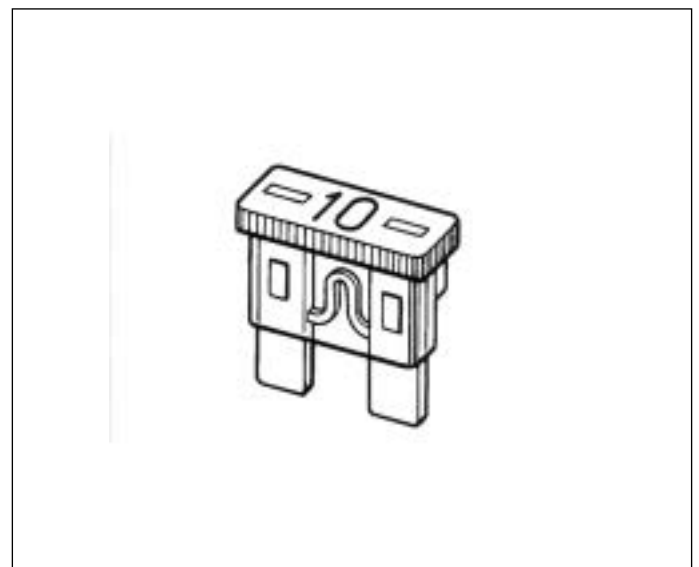



Electrical system

SEMICONDUCTOR PARTS

- Do not drop semiconductor parts such as those incorporated in the ECU.
- When checking these parts, carry out the instructions to the letter. The lack of using the correct procedure can cause grave damage.

INCORRECT

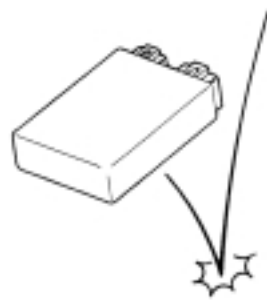

E



Electrical system

ELECTRICAL DIAGRAM

F3 675 - F3 ORO

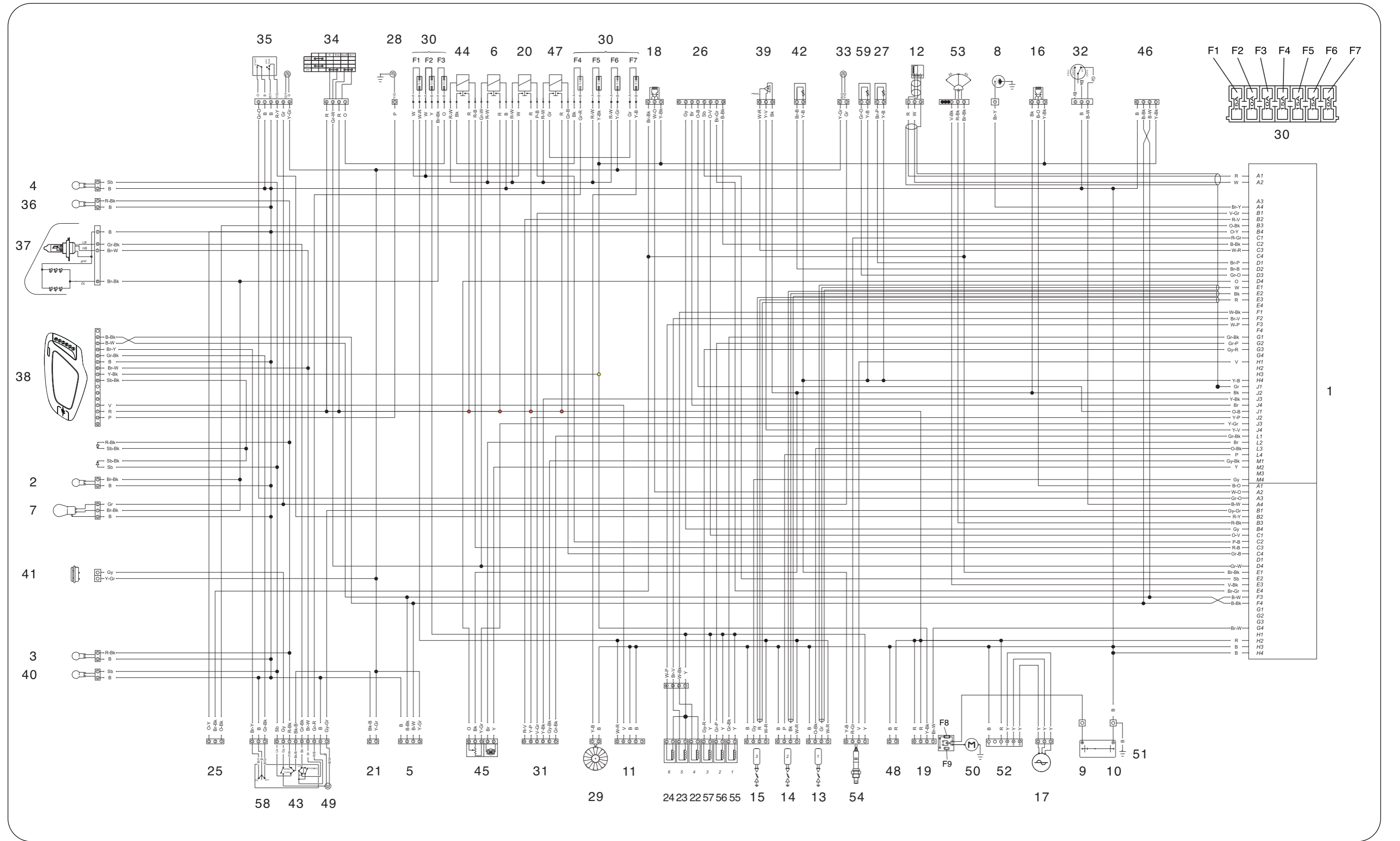



Electrical system

Parts list

Parts list

<i>Ref.</i>	<i>Description</i>	<i>Ref.</i>	<i>Description</i>
1	CPU	33	Rear stop switch
2	Number plate light	34	Ignition switch
3	Right indicator	35	Safety and Front stop switch
4	Left indicator	36	Right indicator
5	Diagnostic connector (5A-serial line RX; 5B-Ground; 5C-serial line TX)	37	Front headlight
6	Main relay	38	Instrument panel
7	Rear and stop light	39	Air pressure sensor
8	Neutral switch	40	Left indicator
9-10	Battery	41	Horn
11	Fuel probe – pump	42	Air temperature sensor
12	R.p.m. sensor	43	Light switch
13	Coil	44	Light relay
14	Coil	45	Exhaust valve actuator
15	Coil	46	Lean angle sensor
16	Front speed sensor	47	Fan relay
17	Alternator	48	Battery recharge
18	Rear speed sensor	49	Clutch switch
19	Solenoid starter	50	Starter motor
20	General feed relay	51	Frame earth
21	Intermittency	52	Voltage regulator
22-24	Upper injectors	53	Angular switch
25	Quick shift	54	Lambda sensor
26	Throttle potentiometer	55-57	Lower injectors
27	Water temperature sensor – CPU	58	SET/OK button
28	Oil switch	57	Water temperature sensor for fan
29	Electric fan		
30	Fuses		
31	“Drive By Wire” Unit		
32	Side stand switch		

Wiring colour code

Fuses list

<i>Letter(s)</i>	<i>Colour</i>	<i>Ref.</i>	<i>Amps (A)</i>	<i>Use</i>
R	Red			
Y	Yellow			
B	Blue			
Gr	Green			
W	White			
Bk	Black			
P	Pink			
V	Violet			
Sb	Sky blue			
Gy	Grey			
O	Orange			
Br	Brown			
		F1	15	Fuel pump - Coils
		F2	10	Lambda sensor - Upper Injectors - Lower injectors
		F3	10	Position lights-License plate light
		F4	15	High beam - Low beam
		F5	15	Solenoid starter - Front/Rear speed sensor - Dashboard - Lean angle sensor
		F6	15	Intermittency - Horn - Stop light
		F7	10	Electric fan
		F8	40	Battery recharge
		F9	40	Battery recharge supply

In combined colors, background and marking colors have been pointed out. E.g.: Br/Bk.



Electrical system

BATTERY

The battery mounted on this motorcycle is a sealed battery therefore no maintenance is required.

The following battery is used: **KOYO KTZ-10S**

This is a sealed battery with breather valve. No electrolyte level checking is required.



Never remove the battery seal caps nor block the breather opening.



During vehicle downtime (e.g. the winter season) it is not necessary to take the battery out. To store the battery simply remove the charger fuse (1) from the remote ignition switch; accordingly, the battery is disconnected from the system.

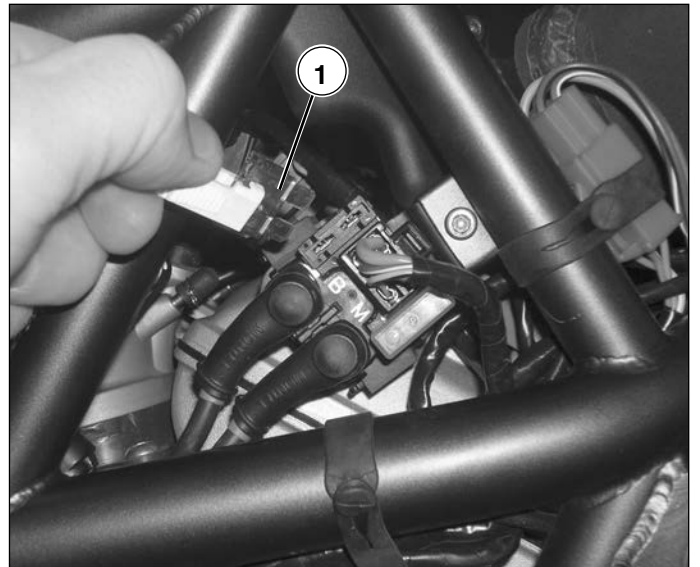

E



Electrical system

CHARGING THE BATTERY

The battery is charged by connecting the supplied battery charger to the connector located under the passenger seat. If the battery is charged after a period of vehicle downtime, make sure that the charger fuse is placed inside its housing on the remote ignition switch. Put the motorcycle key inside the rear lock. Turn the key clockwise and at the same time turn the passenger seat.

Take out the rubber cap (1) for the charger connector.

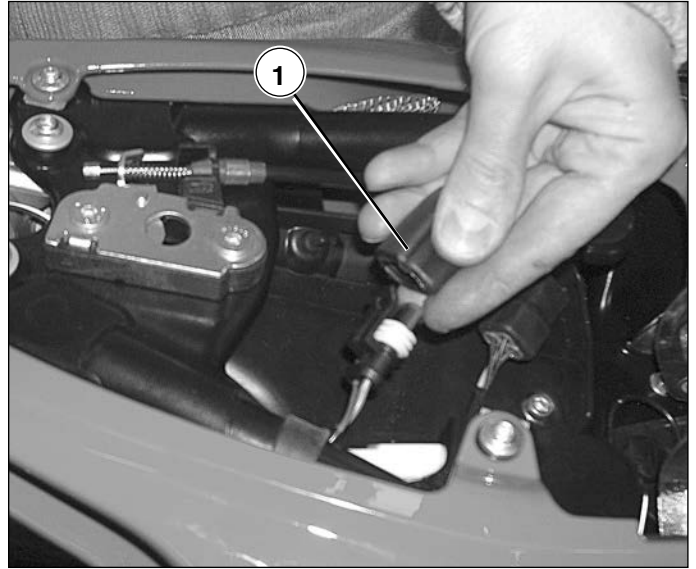

Before charging, connect the battery charger to the connector of the vehicle as shown in the figure. Then connect the battery charger to the AC outlet.

The amber light will go on indicating that it has started charging, and will last between 0 and 12 hours depending on the battery conditions.

When charging is complete the green light will come on.

The supplied battery charger is equipped with a safety system that produces voltage in output only if the polarities of the cables are correct and the battery that you intend to charge has a voltage of at least 3V.

When connected, the battery charger automatically detects the battery conditions, delivering optimal voltage values and current intensity to maximise performance and increase the duration of the service life of the battery.

If the supplied battery charger is not available, it is possible to use other types of battery chargers with a constant voltage charging method to avoid overcharging the batteries, as shown in the table on the side.

Overcharging the battery or charging it rapidly may lower the level of the electrolyte, thus making the battery unusable.



Method	V (voltage)	C (temperature)	A (charging current)	Charging time (hours)
Normal	14,4	20	0,25xC	12-24
Fast	14,4	20	1xC	6-8

NOTE Voltages lower than 11.8V shorten the life and impair the operation of the battery. Checking stored batteries once a month prolongs their life while keeping them in perfect working order for future use.

REMOVAL OF THE BATTERY

To carry out this operation it is necessary to remove the rear cowl, the sides and the tank as described in sec. C (Bodyworks).

1) Remove the negative pole (-) cable screw first.

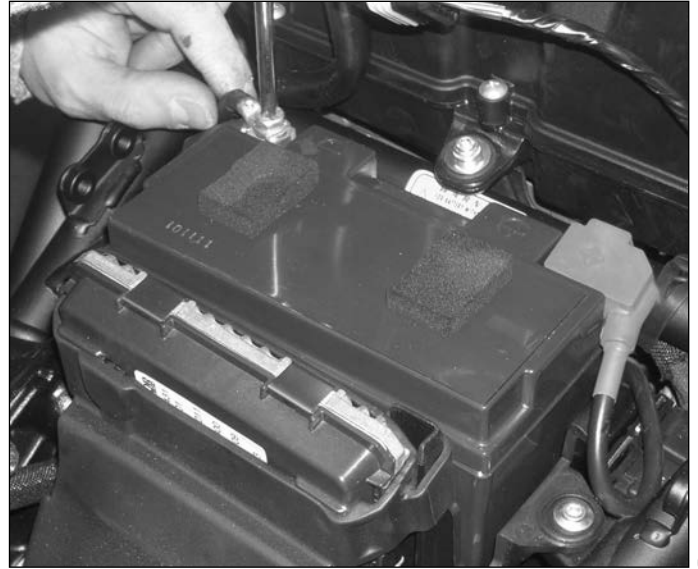

2) Remove the positive pole (+) cable screw first.

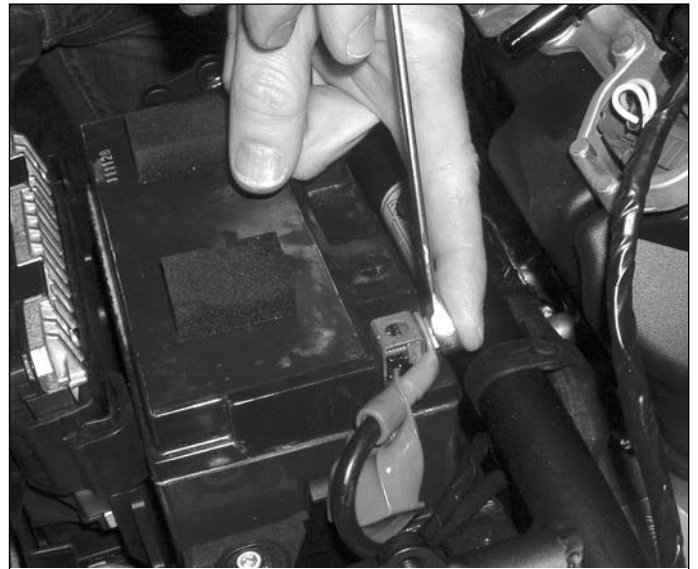

3) Remove the battery by lifting it from its housing.

To install the battery carry out the disassembly operations in reverse order beginning by connecting the positive terminal (+) on the relative pole of the battery, tightening the screw with a torque of $7 \div 8$ Nm. Then set up the protective cover on the positive pole. Install the 2 negative terminals (-) on the relative battery pole observing the set up shown in the figure and tightening the screw with a torque of $7 \div 8$ Nm.





Electrical system

- Check the voltage charge after about thirty minutes at the battery terminals.
Voltage $\geq 12,5$ Volt.



E

CHARGING SYSTEM

Warning function

Conditions of abnormal operation of the battery charging function (voltage $\geq 10V$) is indicated by the warning lamp and the voltage value displayed on the dashboard.

As shown in the figure, the temperature influences the characteristics of the regulator with steps of variation of the regulated voltage.

8. Tareg-reg CHARACTERISTIC DIAGRAM

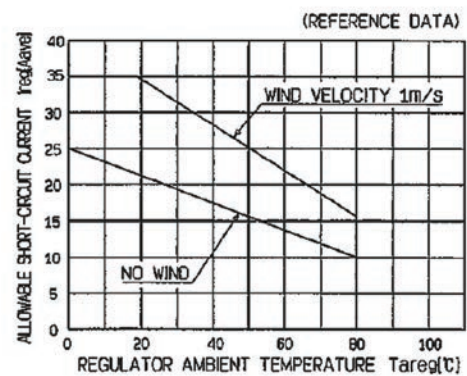

※Heat radiation depends on the model and the ambient condition. So please check the temperature with actual vehicle and the condition.



Electrical system

A list of possible problems that could occur when the warning light is switched on.

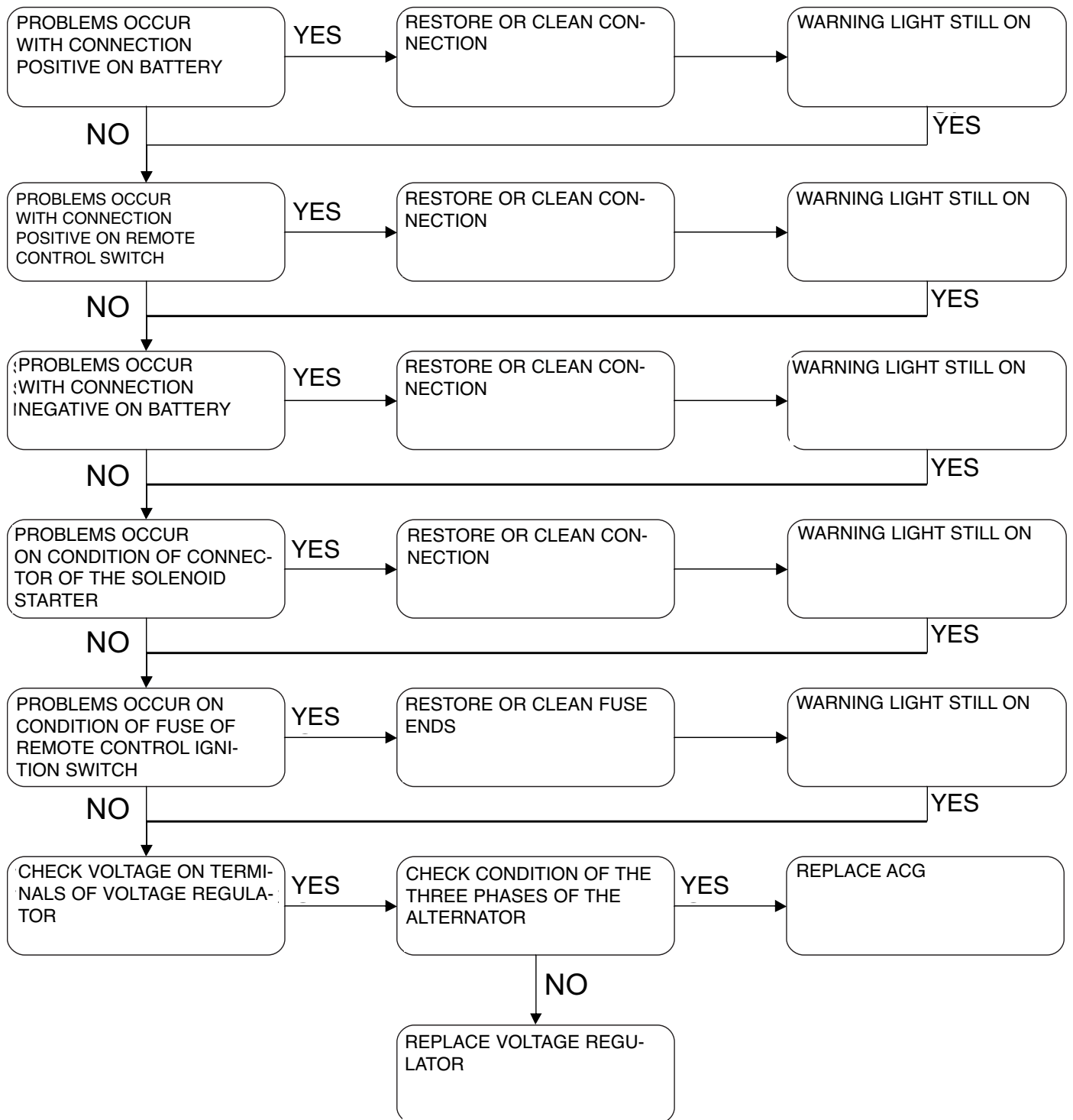

E

BATTERY EFFICIENCY CHECK

Battery current loss check

- Remove the seats as described in chapter C “Bodywork”.
- Turn the ignition switch to the “OFF” position.
- Disconnect the cable from the negative (-) pole of the battery.
- Connect the multi-tester between the negative (-) terminal and the negative (-) cable of the battery.

Losses are indicated if the tester measures more than 2÷2.5mA.

Battery current loss: less than 1mA.

- First of all when using an ammeter, utilise a high range of the multi-tester because the current losses in the case of malfunctioning could be elevated**
- Do not turn the ignition switch to the ON position while measuring the current.**

If losses are found, search for the part where the tester measures less than 2÷2.5mA by removing couplings and connectors one at a time.

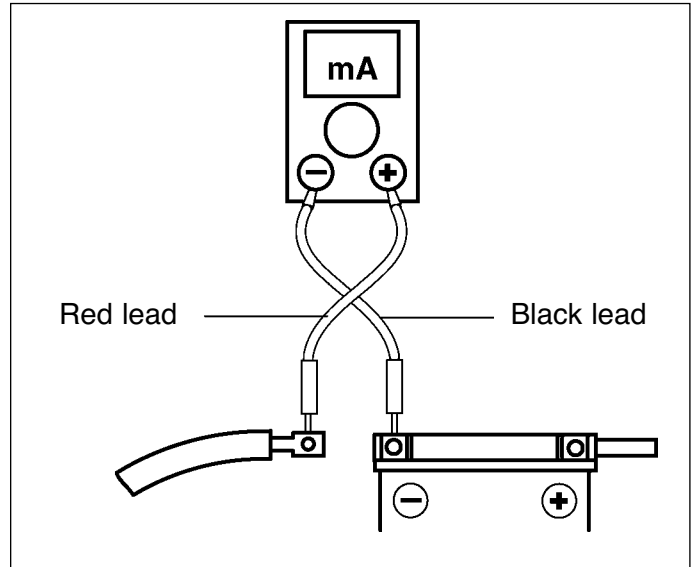

Charge feed check

- Remove the seat as described in chapter C “Bodywork”.
- Start the engine and let it idle.
- Make sure that between one of the two red ignition relay wires and the engine earth the voltage is greater than 14 V.





Electrical system

Measure the DC voltage between the positive (+) and the negative (-) terminals of the battery with a multi-tester. If the tester indicates less than 12.6V or more than 14.5V the cause will be found in the generator.

NOTE When carrying out this check, ensure that the battery is fully charged.

Feed charge

Standard: 13,5 - 14,5V at 2000 r.p.m.

STARTER SYSTEM

The diagram below represents the starter system.

START SWITCH	CLUTCH LEVER	GEAR POSITION	STAND POSITION
RUN	PULLED	NEUTRAL	UP
RUN	PULLED	NEUTRAL	DOWN
RUN	PULLED	ANY	UP



Electrical system

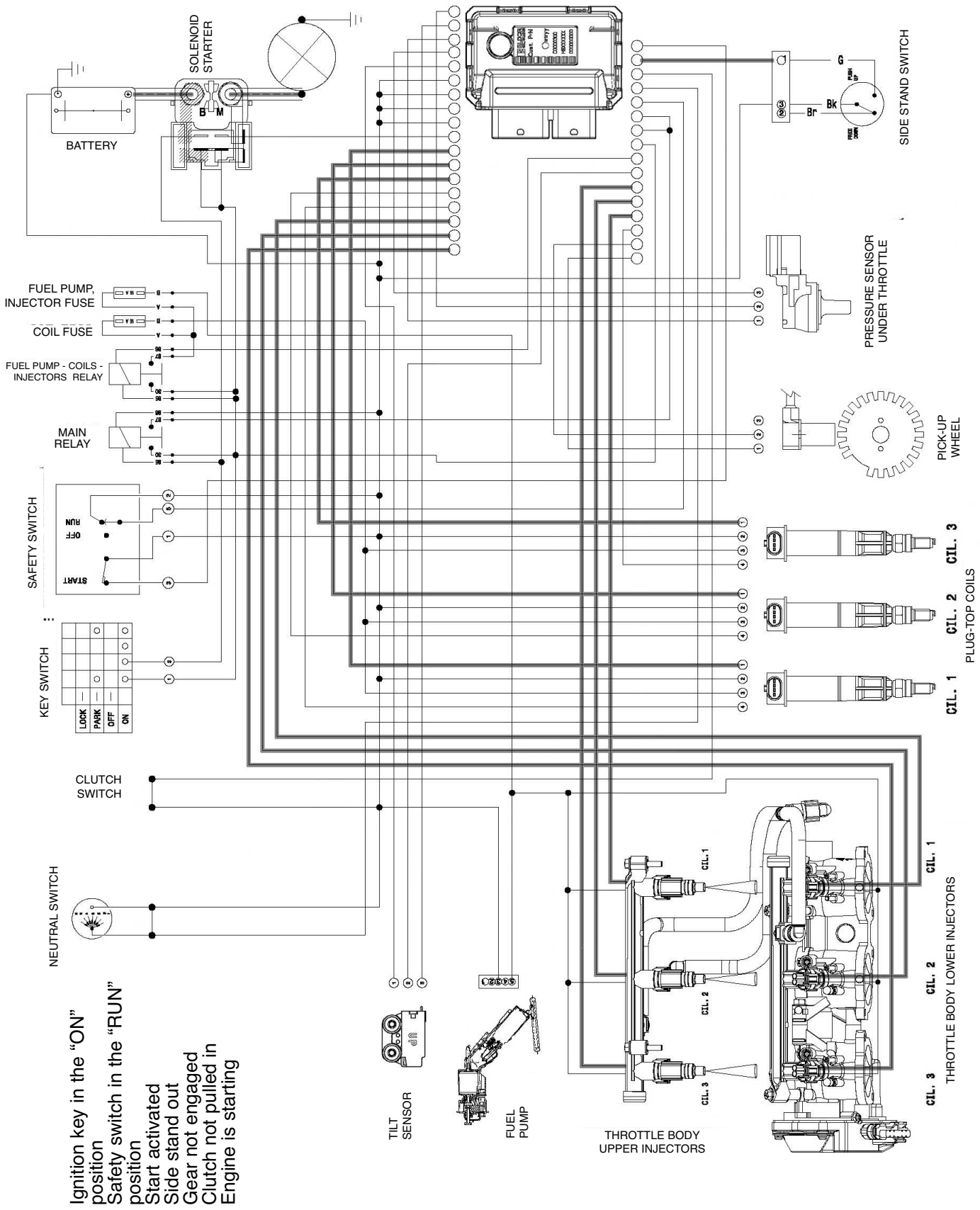

Ignition key in the "ON" position
 Safety switch in the "RUN" position
 Start activated
 Side stand out
 Gear not engaged
 Clutch not pulled in
 Engine is starting

E



Electrical system

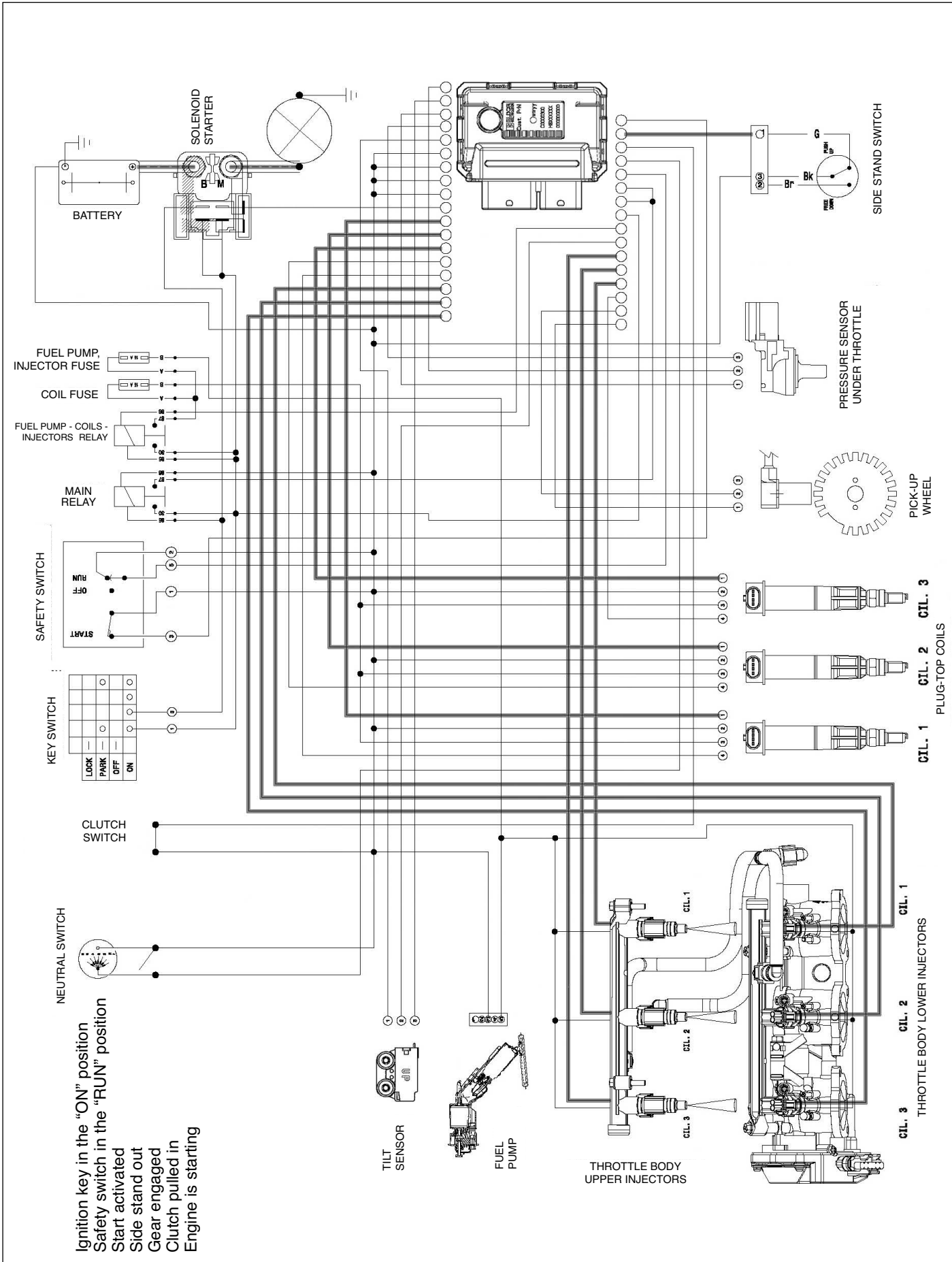

Ignition key in the "ON" position
 Safety switch in the "RUN" position
 Start activated
 Side stand out
 Gear engaged
 Clutch pulled in
 Engine is starting





Electrical system

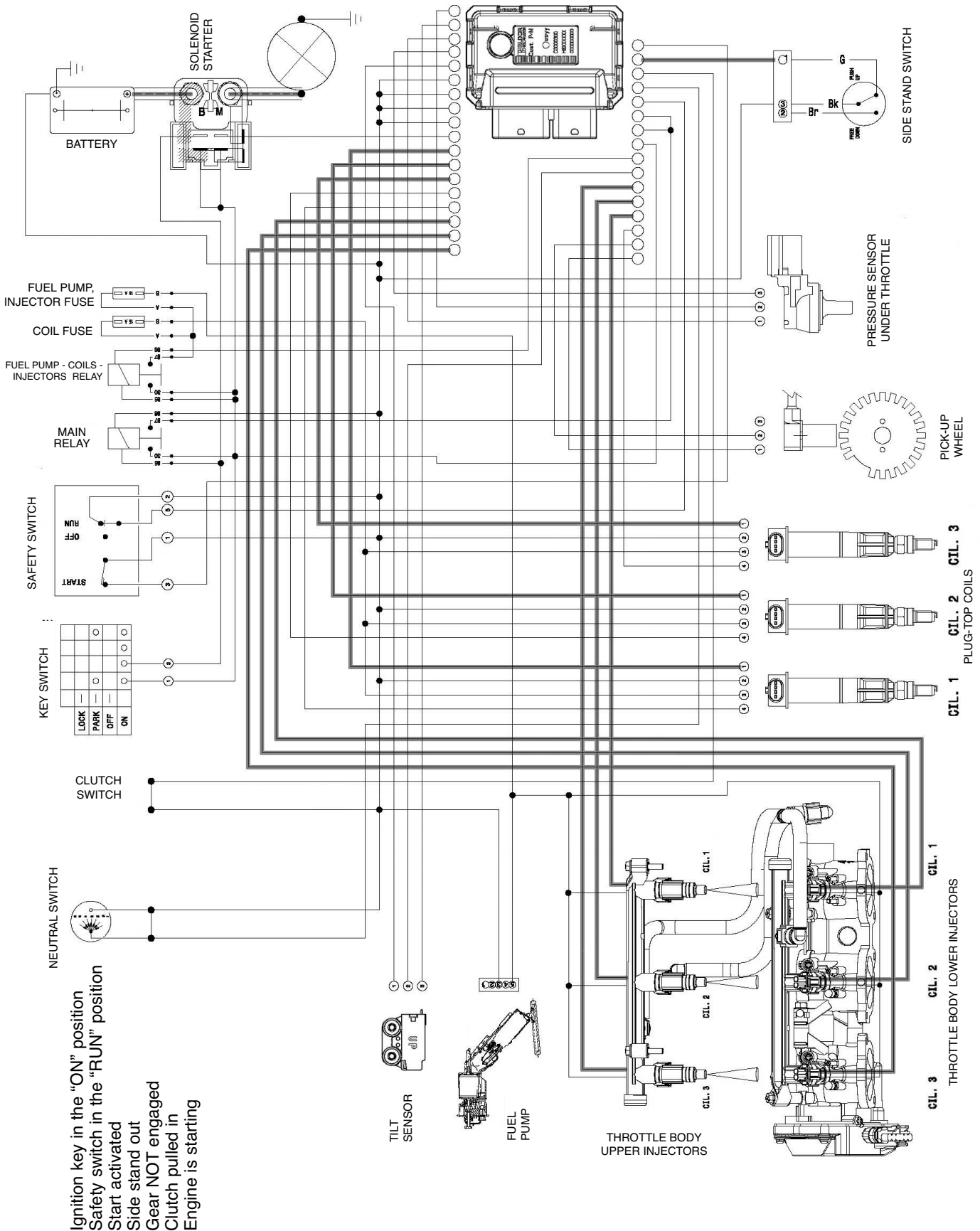

Ignition key in the "ON" position
 Safety switch in the "RUN" position
 Start activated
 Side stand out
 Gear NOT engaged
 Clutch pulled in
 Engine is starting



Electrical system

CHECKING THE GENERATOR

- Disconnect the generator connector.

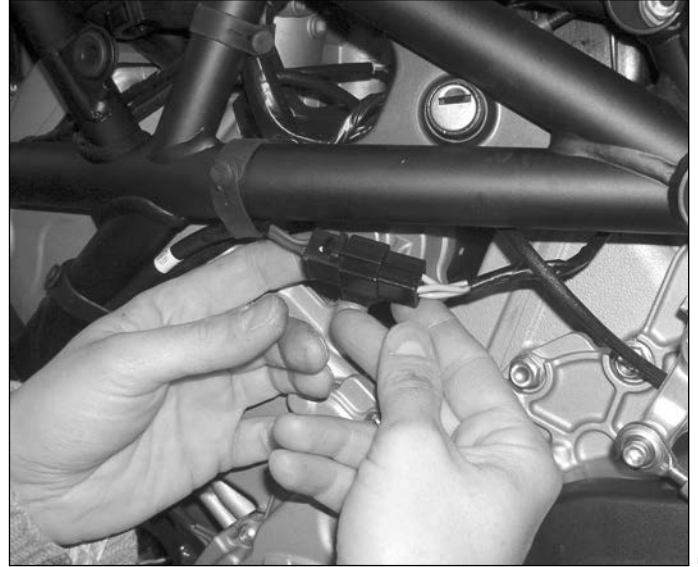

- Make sure that there is a resistance of 0.3 Ohm $\pm 10\%$ at 20°C between each of the contacts of the 3 pins (generator line).



- Make sure that there is NO continuity between each of the 3 pins and the engine earth.



E

STARTER MOTOR REMOVAL

- Remove the fuel tank (see chapter C “Bodywork”).
- Remove the battery mounting by unscrewing the three clamping screws (1).
- Remove the seat lock plate.
- Remove the blow-by tube.
- Disconnect the cable of the starter motor.



- Remove the two fixing screws (2) of the starter motor.



- Remove the motor by sliding it out from the ignition cover and taking it out from the battery compartment.





Electrical system

STARTER MOTOR CHECK

If a fault has been diagnosed in the starter motor, it is necessary to proceed as follows with the check:

- Connect a tester between earth and the starter motor terminal.
- Check that there is continuity between the positive pole and the engine earth. If there is no continuity, substitute the starter motor.

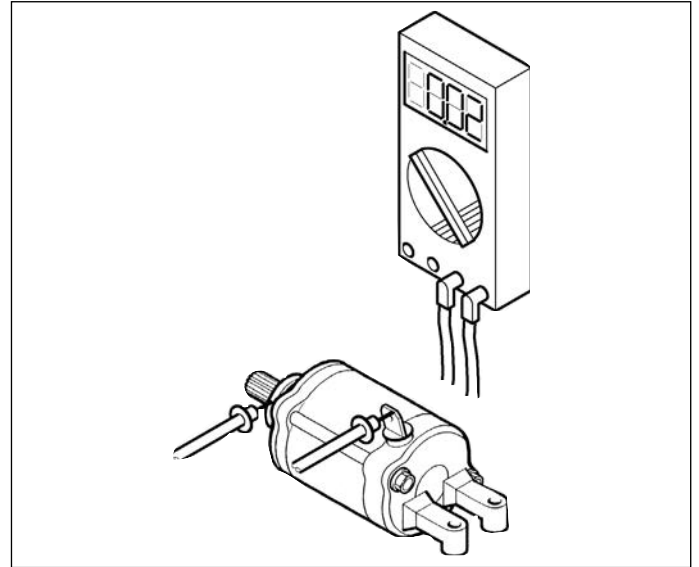

STARTER MOTOR ASSEMBLY

Assemble the starter motor in the reverse order of removal. Pay attention to the following points:

 **Substitute the O-ring with a new one to avoid oil leakage and the ingress of humidity.**

- Apply grease to the oil seal lip.
- Apply a small quantity of MOLYKOTE to the rotor shaft.
- Apply a small quantity of LOCTITE 243 to the bolts of the starter motor.

STARTER RELAY CHECK

- Disconnect the start-up relay connector.





Electrical system

- Disconnect the cables of the starter motor and the positive cable of the battery from the relay.

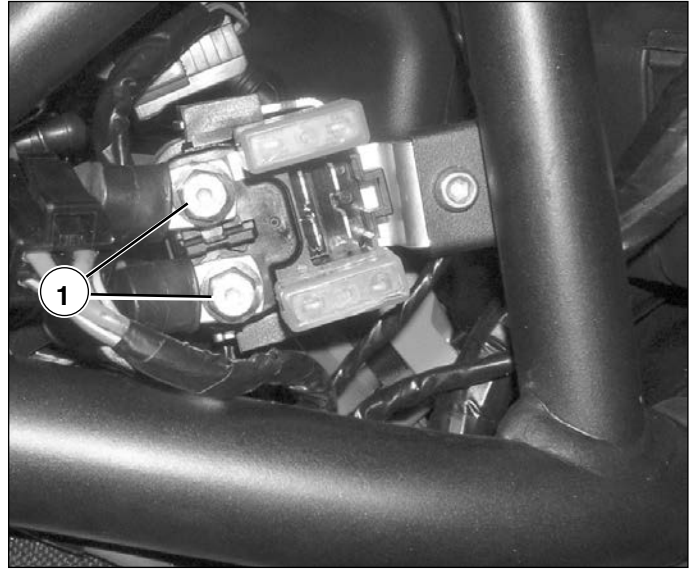

Apply 12 volts to the terminals (1) and (2) of the relay and check the continuity between terminals B-M.



Do not apply the battery voltage to the starter relay for more than five seconds to avoid overheating and therefore damaging the winding.

- Using a multi-tester, check that the winding is on open circuit or if a resistance is present. The winding is in good condition if the value of the resistance revealed is as indicated.

Multi-tester dial indication: ohm Ω
Starter relay resistance
Standard: 5 Ohm $\pm 10\%$ 20°C

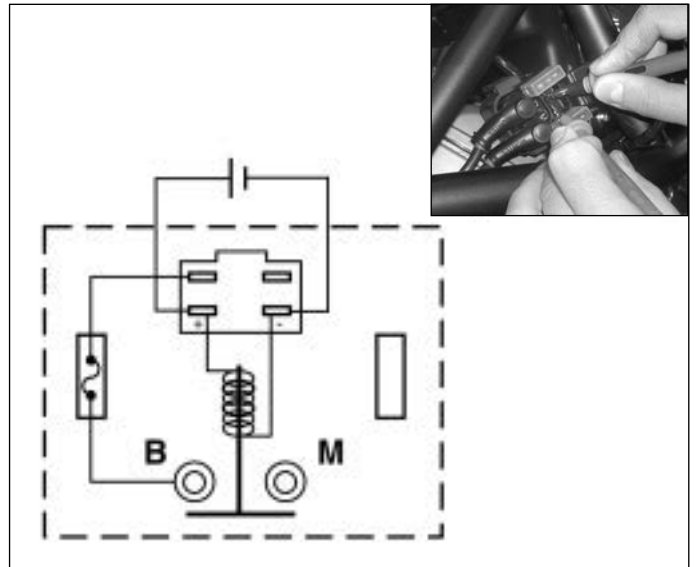

TILT SENSOR

The fall sensor (1) acts on the engine control unit, interrupting power when a vehicle tilt of more than $60^\circ \pm 10^\circ$ for more than 3 seconds.





Electrical system

GEARCHANGE POSITION SWITCH

The connector (1) of the gear position sensor is located on the left beneath the tank.

Disconnect the connector of the gear position switch and check the resistance value, using a multitester, in the six gears as well as the idle position, as shown in the attached table.

SCHEMA ELETTRICO ELECTRICAL SHEET

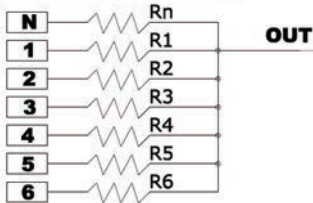

Rn	15400 ± 150.4	
R1	6650 ± 66.5	
R2	3650 ± 36.5	
R3	2210 ± 22.1	
R4	1330 ± 13.3	
R5	732 ± 7.32	
R6	316 ± 3.16	

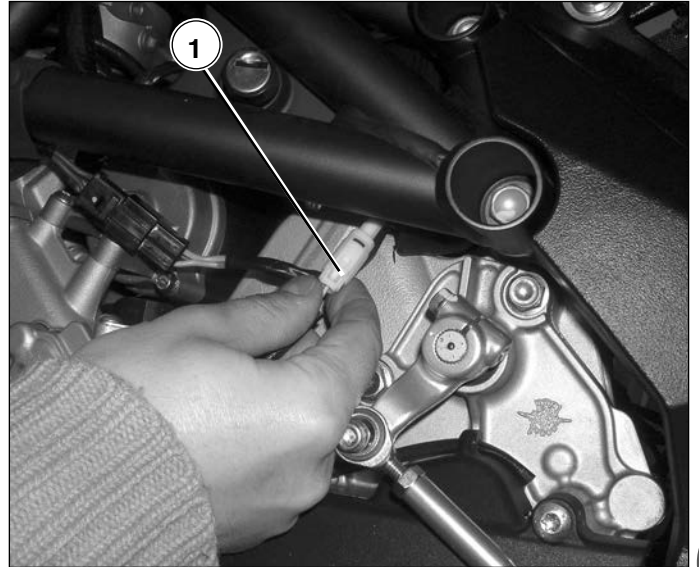

When the connector of the gearchange position switch is connected and disconnected, be sure to turn the ignition switch to the "OFF" position to avoid damaging the electronic parts.



SIDE STAND SWITCH

The connector for the lateral stand switch is mounted on a support under the pinion wheel transmission casing on the left side of the motorcycle.

- Remove the left fairing.
- Disconnect the connector of the side stand switch and check continuity as described in the table:

	Green	Yellow/Black
ON (Raised)		
OFF (Lowered)		

After the tests described above, whenever it is necessary to replace the switch, proceed as indicated in chapter B Maintenance.





Electrical system

FUSES

The fuses are situated on the right side of the motorcycle.

Remove the right side fairing.

Lift the rubber cover.

The fuses for the services are numbered from 1 to 7 starting from the left; there are three spare fuses on the part underneath.

The charger fuse is located on the remote switch higher up than the spare fuse.

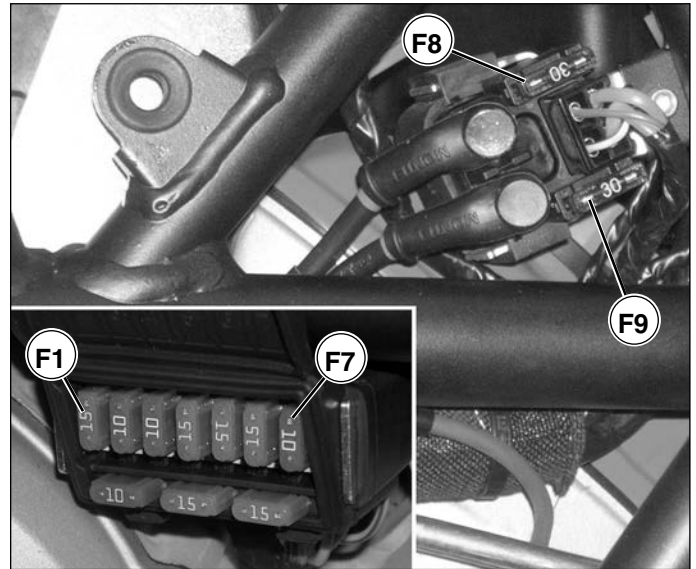

 **To avoid damage to the electrical system, before changing a fuse, turn the ignition key to OFF.**

Replace the burnt fuse with the provided tweezers and then close the cover back up.

To identify the position and function of the fuses, refer to the table.

Fuse	Amp. (A)	Application	Position
F1	15	Fuel pump - Coils	Fuse Box
F2	10	Lambda sensor - Lower Injectors - Upper Injectors	Fuse Box
F3	10	Position lights - License plate light	Fuse Box
F4	15	High Beam/Low Beam	Fuse Box
F5	15	Solenoid Starter - Dashboard - Front/Rear speed sensor - Lean angle sensor	Fuse Box
F6	15	Intermittence - Stop light - Horn	Fuse Box
F7	10	Electric fan	Fuse Box
F8	30	Battery recharge	Solenoid starter
F9	30	Battery recharge supply	Solenoid starter

 **IMPORTANT! Be careful to restore the correct fuse amperage. Using an amperage that differs from the required one could damage the electrical parts of the vehicle causing a fire hazard.**



Electrical system

SPARK PLUGS

Remove the components of the motorcycle to remove the spark plugs as described in chapter B "Maintenance".



Remove the spark plugs utilising the appropriate 16mm hexagonal spark plug spanner.

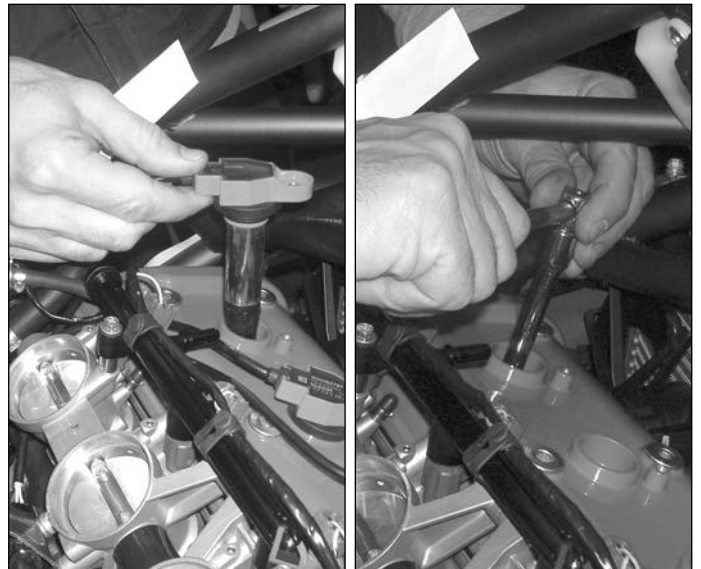

Check the resistance between the electrode and the screw cap of the spark plug as shown in the figure.

Permitted resistance: $4,5 \div 5,5 \text{ K}\Omega$

Carry out the test on all the spark plugs.



Do not use non-resistive spark plugs.



E



Electrical system

MAIN RELAY

The main relay is on the right side of the battery compartment and it is identified by the “M” letter.



To operate the relays conveniently it is necessary to remove the battery and its mounting.



Take the general relay out (**M**) from the connector and check that there is a resistance of 82 Ohm $\pm 10\%$ at 20°C between pins 1 and 3.





Electrical system

ENGINE PICK-UP

The engine pick-up is situated on the left side of the motorcycle. To check this component it is necessary to identify the relative connector positioned as shown in the figure, inside the frame on the left side of the motorcycle.



After having disconnected the pick-up connector, measure the resistance between the two points identified by a (+) and a (-) that are indicated on the connector.

Pick-up resistance value: ~ 680 – 700 Ω



E.A.S. (electronically assisted shift is not included in all models)

E.A.S. mode, which can be selected from the menu, is used to change gear without using the clutch and without closing the gas knob.

Installed on the gear change rod, this device detects the pressure exerted on the gear lever and sends the information to the ECU, which blocks the supply of electric current to the reels by lowering the torque value of the gear for the amount of time required to engage the next gear.

Remove the connector and check continuity between pins 2 and 3 through the pressure sensor (gear lever raised).

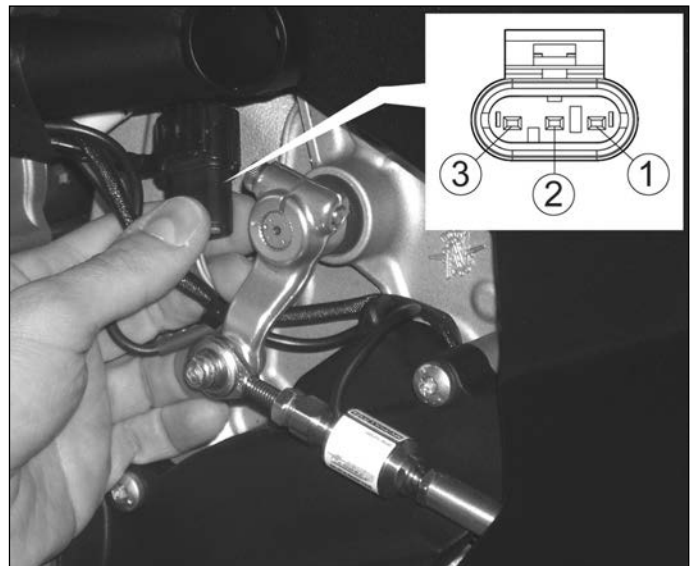



Electrical system

TIMING WHEEL GAP

To guarantee the correct functioning of the pick-up it is necessary to measure the gap between the pick-up and the timing wheel by utilising a feeler gauge as shown in the figure.

Gap width: 0.6 – 0.7 mm

To carry out this check it is necessary to remove the cover of the timing wheel by consulting the Workshop Engine Manual.

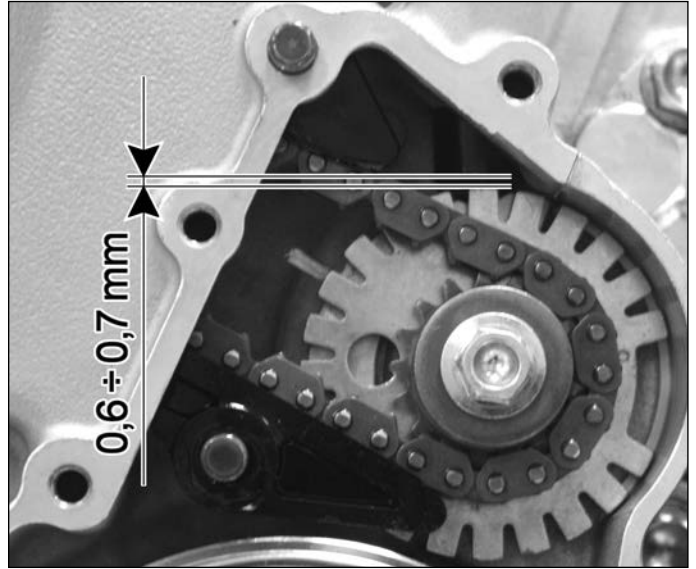

RUN OFF SAFETY SWITCH

Remove the right fairing side panel as described in chapter C “Bodywork”.

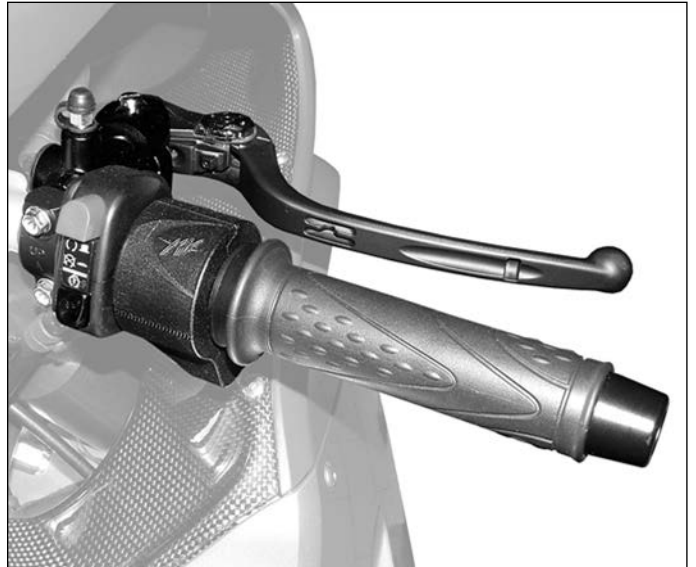

Remove the relative connector to the right hand control group as indicated in the figure.

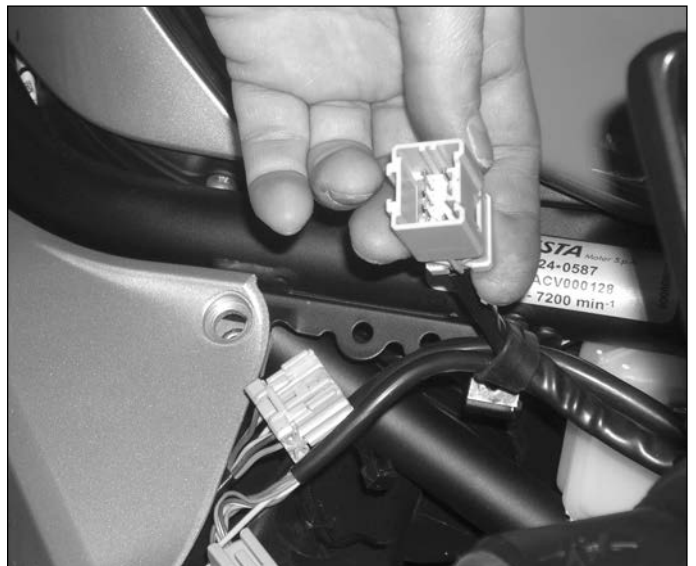



Electrical system

Remove the connector holding device.

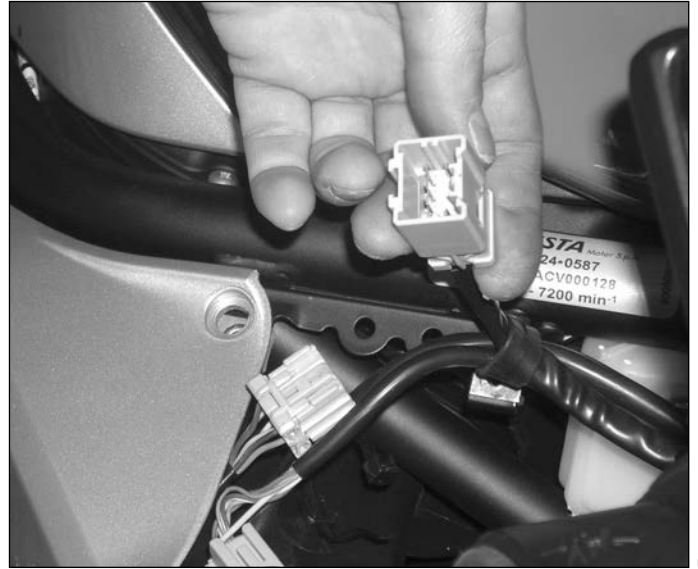

With the switch in the RUN position make sure there is continuity between the Y/R (yellow/red) and Y/W (yellow/white) wires.

Holding the START button down, make sure there is continuity between the Y (yellow) and W/R (white/red) wires.



INSTRUMENTATION

If faults are found in the instrumentation, it is necessary to check the main wiring and the various components assisted by the same instrumentation. To carry out the various checks after having removed the fairing side panels and the nose fairing as described in chapter C "Bodywork", it is necessary to remove the rubber cap (1) and then the connector (2) situated behind the instrumentation.

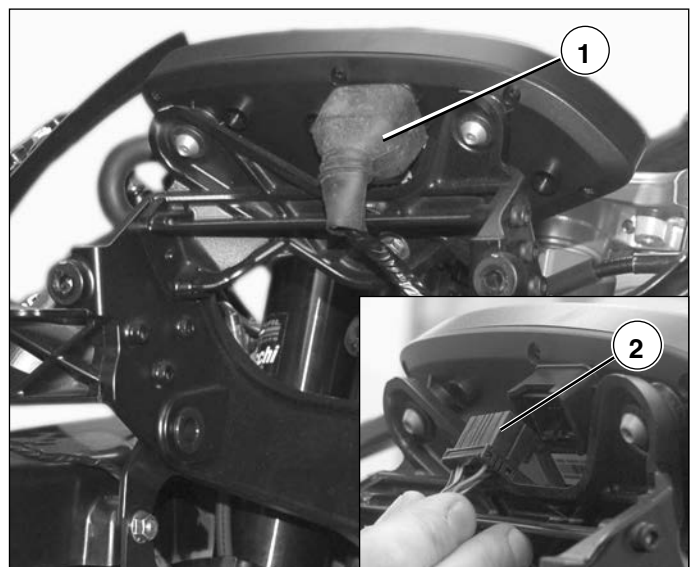



Electrical system

Consult the diagram below to identify the contacts of the various components:

1 Supply	9 Turning led
2 Gnd	10 Oil pressure
3 + CAN	11 Ignition key
4 - CAN	12 -
5 SET SWITCH	13 -
6 High beam	14 -
7 Fuel warning led	15 -
8 -	16 OK SWITCH

16 pin AMP 174975-2

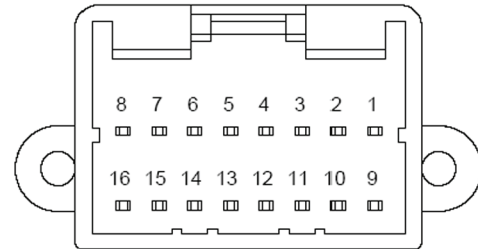

OIL PRESSURE SENSOR

To check the good functioning of this component with the engine switched off, it is necessary to find the continuity between the contact of the sensor and the earth of the motorcycle as shown in the figure.

With the engine switched on, the contact must be interrupted.



FUEL LEVEL WARNING LIGHT CHECK SWITCH

After having checked the breakdown of the fuel reserve warning light, check that there is continuity between terminal 4 of the tank flange and terminal 7 of the dashboard.





Electrical system

Having ascertained the good condition of the fuses in question, proceed as follows:

With the fuel tank removed from the motorcycle and empty of fuel, connect a small circuit composed of 12V battery and a light bulb of 12V – 1.7W to the connector of the fuel level indicator as shown in the diagram.

If the switch is in a good condition, the light bulb should light up after several seconds.

Pour some fuel into the fuel tank and confirm that the light bulb switches off after having poured more fuel into the tank than the maximum required for the reserve.

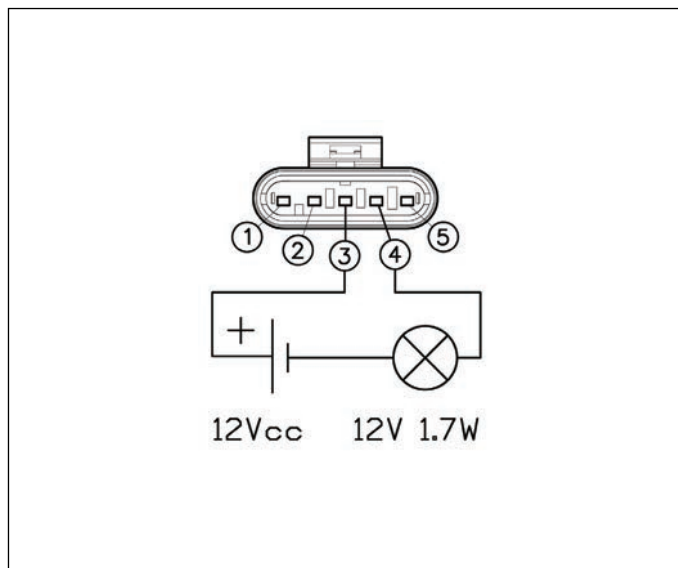

WATER SENSOR

Verify sensor operation by measuring resistance between the pin by means of a tester.

$$U_b = 5 \text{ V} \pm 10 \%$$

$$R_v = 2000 \text{ Ohm} \pm 1 \%$$

TEMP. °C	RESIST. Ω	TEMP. °C	RESIST. Ω
-40	104442,9	60	703,8
-35	74642,1	65	589,9
-30	53932,5	70	496,7
-25	39383,0	75	420,1
-20	29050,7	80	356,9
-15	21637,5	85	304,4
-10	16266,4	90	260,7
-5	12338,0	95	224,1
0	9439,2	100	193,3
5	7281,6	105	167,6
10	5661,8	110	145,6
15	4436,0	115	127,0
20	3501,9	120	111,1
25	2806,8	125	97,5
30	2264,5	130	85,9
35	1837,7	135	75,8
40	1500,7	140	67,1
45	1231,7	145	59,6
50	1016,9	150	53,1
55	843,9		





Electrical system

KEY SWITCH

Whenever the dashboard, with the switch on the ON position, is not powered, first check the conditions of the fuse located on the starter relay and, if this should be in good condition, check the conditions of the fuse located in position 5 on the fuse box.

Check these two conditions, if the fault persists perform the continuity test according to the following table:

Key Position	Cables colour			
	R	G\W	Br\W	Br\Bk
ON	○ — ○			
			○ — ○	
OFF e PARK	○	○		
			○	○



TURN INDICATORS

If the blinker warning lights do not work, continuity must be checked on the cable R-B between terminal **7** of the switch connector and terminal **9** of the dashboard connector.

Check continuity between the G (green) - Bk/W (black/white) wires for the Lh indicator and between the G (green) - Y/W (yellow/white) wires for the Rh indicator.



R.P.M. SENSOR

Engine rev information on the dashboard arrives by means of a CAN line; therefore, if this information is not displayed and the message CAN ERROR appears on the dashboard, the problem can be attributed to the dashboard.



Electrical system

SPEED SENSOR

Whenever the speed is not indicated on the dashboard and the message SPEED SENSOR appears, proceed as follows:

- Check the conditions of the fuse in position 1 on the fuse box.



If the fuse in question is in good condition, proceed with the check of the speed sensor as follows:

Keeping the sensor connected to the system and with the key ON, use a Tester to make sure that when the sensor is placed in front of a tooth of the phonic wheel, between terminal 3 and terminal 2 of the connector, that the voltage is close to zero, whilst when it is not placed in front of one of the nuts, the voltage is close to that of the battery.

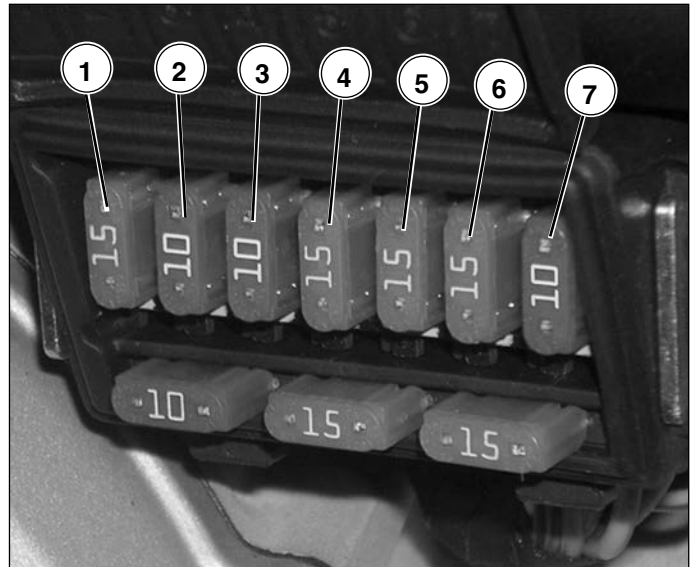

LOW BEAM HEADLIGHT

In the event that the dipping beam does not work, check the conditions of fuse **3** on the fuse box. If this fuse is ok, check the conditions of the relay situated on the left side of the motorcycle, with the label "**B**".

If this condition is also met, check the continuity of the R/B cable that goes from relay "**B**" to the engine control ECU to vehicle connector terminal **C3**.

E



HIGH BEAM HEADLIGHT

In the event that the driving beam does not work, check the conditions of fuse 4.

E

If the fuse is ok, check the continuity of the left handle-bar control connector between positions between the YB (yellow/blue) and the Y (yellow) wires with the driving beam function selected.



If this is also ok, the problem can be attributed to the headlight unit.

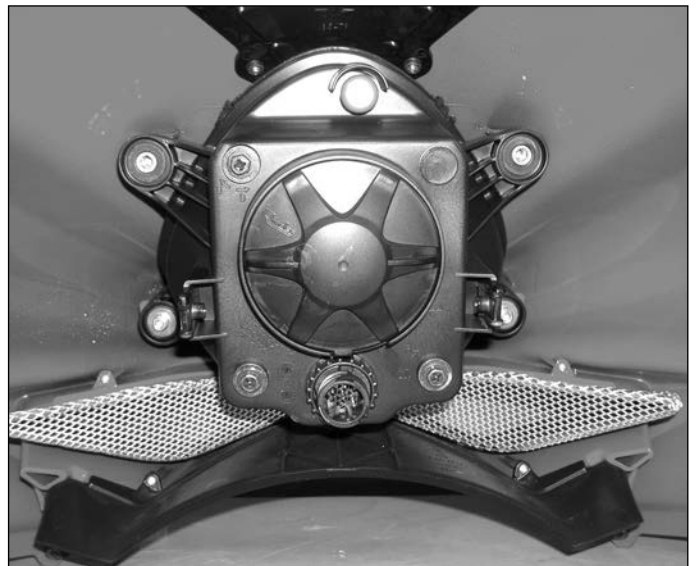



Electrical system

After having checked the bulbs of the headlight, the relative fuses and the controls as described herewith, proceed with checks of the relay **B** on the left side of the motorcycle.



TURN INDICATORS

In the event that turn indicators do not work, check the conditions of fuse **6** on the fuse box.

If the fuse is ok, check the continuity between terminals **6-7** and **6-5** respectively for left and right indicators on the left control.

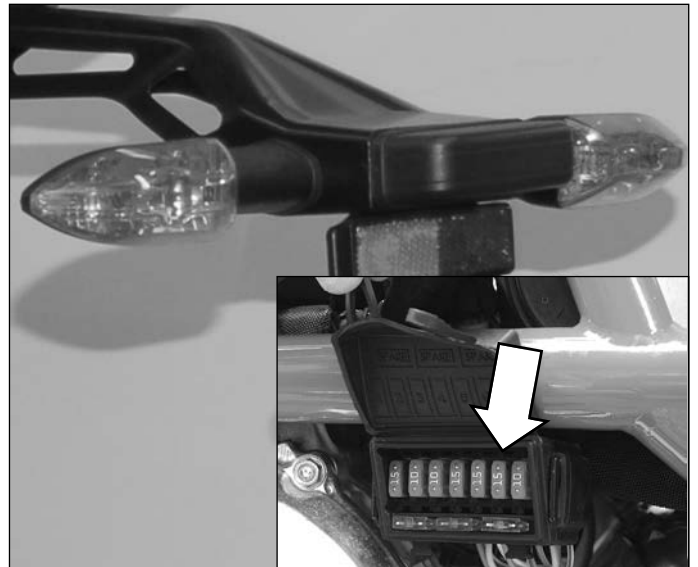

REAR TAIL LIGHTS AND BRAKE LIGHTS

In the event that tail lights and brake lights do not work, check the conditions of fuse **6** for the brake light and **3** for tail lights.

If the conditions are met, check the continuity of the right control of terminals **4** and **5** and terminals **1** and **2** of the rear stop connector.



E

LICENCE PLATE LIGHT

If the number plate light bulbs do not function, check the condition of fuse **3** in the fuse box; if these are ok, replace the bulb.

- Remove the rear reflector, removing its fixing nuts.
- Remove the fixing screw of the plate holder.

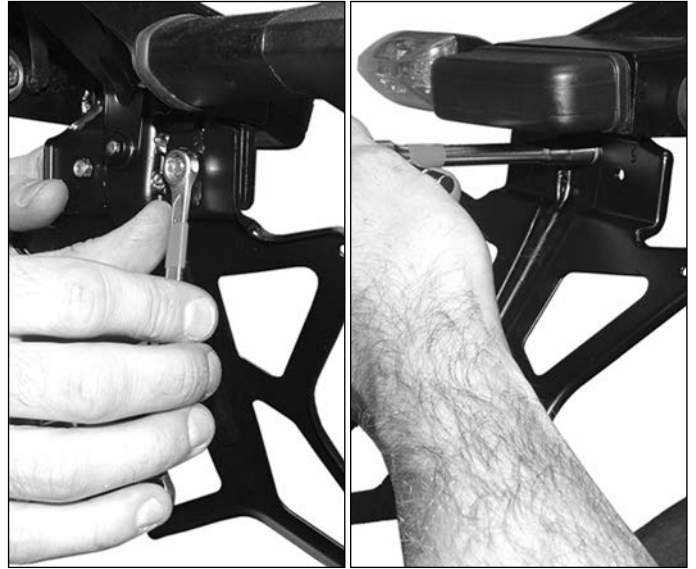

- Remove the fixing nuts the plate holder.
- Remove the plate holder.



- Extract the bulb holder pulling it from its seat.





Electrical system

- Extract the burnt-out bulb.
- Fit the new bulb.
- Replace the bulb holder.
- Replace the plate holder and the rear reflector.

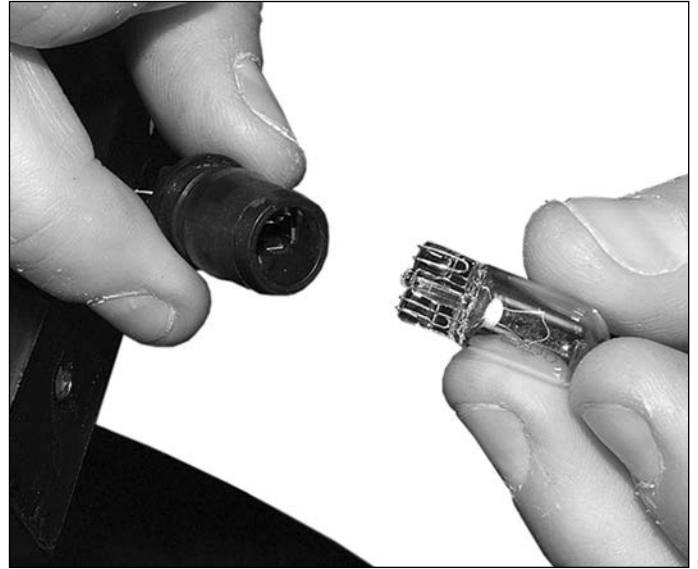

E

COOLING FAN SYSTEM

If there is a fault in the functioning of the cooling fan, proceed with the following check::

- Check the condition of fuse 7;
- If the fuse is in good condition, check the cooling fan relay mounted on the right side of the battery compartment, marked with the letter "F".

If the relay is in good condition but is not energised aboard the vehicle, check the temperature sensor, located on the radiator.

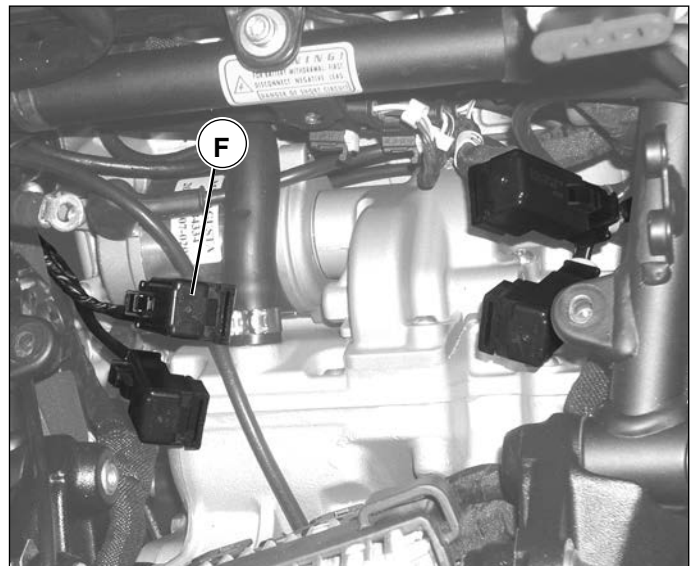
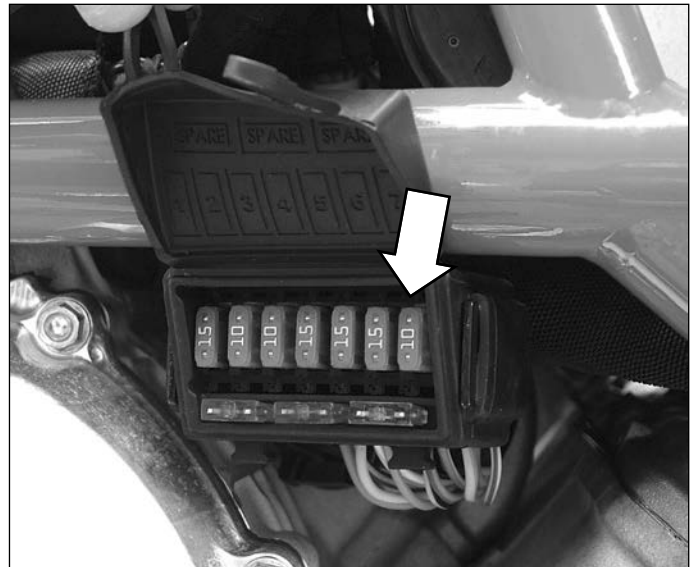



HORN

A fault in the horn system should be checked at various points:

- Check the condition of fuse **1** in the fuse box.
- If the fuse is in good condition, disconnect the connector of the left control and check the continuity between contact **3-4** of the control with the horn button pressed as in the following page under “Switches”.
- Check the continuity of the winding of the horn.



ECU DISASSEMBLY

To carry out this operation it is necessary to disconnect the battery cables. Take the ECU out of its housing and remove the engine connector first (red, right side) pressing the hook and turning the safety bracket.

Repeat this operation on the vehicle connector (blue, left side).

To re-install it perform the disassembly steps in reverse order.





Electrical system

SWITCHES

Check the continuity of each switch with a tester. If there is any anomaly, substitute the respective switch unit with a new one.

R.H. switch

START SWITCH		
WIRE COLOUR	W/R	Y
POSITION		
FREE	<input type="radio"/>	<input type="radio"/>
PUSH	<input type="radio"/>	<input type="radio"/>

ENGINE STOP SWITCH		
WIRE COLOUR	Y/W	Y/R
POSITION		
KILL	<input type="radio"/>	<input type="radio"/>
RUN	<input type="radio"/>	<input type="radio"/>

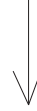

L.H. switch

BLINKER SWITCH			
WIRE COLOUR	Bk/W	G	Y/W
POSITION			
N PUSH TO OFF	<input type="radio"/>	<input type="radio"/>	<input type="radio"/>
LEFT	<input type="radio"/>	<input type="radio"/>	<input type="radio"/>
RIGHT	<input type="radio"/>	<input type="radio"/>	<input type="radio"/>

HORN SWITCH		
WIRE COLOUR	Gy	W
POSITION		
FREE	<input type="radio"/>	<input type="radio"/>
PUSH	<input type="radio"/>	<input type="radio"/>

(JST 3P CONNECTOR)

MODE SWITCH			
WIRE COLOUR	P/Br	W	Y/Br
POSITION			
OK	FREE	<input type="radio"/>	<input type="radio"/>
	PUSH	<input type="radio"/>	<input type="radio"/>
SET	FREE	<input type="radio"/>	<input type="radio"/>
	PUSH	<input type="radio"/>	<input type="radio"/>

PASSING SWITCH		
WIRE COLOUR	Y	Y/B
POSITION		
OFF	<input type="radio"/>	<input type="radio"/>
ON	<input type="radio"/>	<input type="radio"/>

DIPPER SWITCH			
WIRE COLOUR	W/R	Y/B	Y
POSITION			
LOW	<input type="radio"/>	<input type="radio"/>	<input type="radio"/>
HI	<input type="radio"/>	<input type="radio"/>	<input type="radio"/>

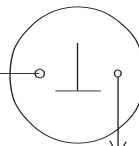

W

Y/R

Y

Y/B

POSITIONING OF ELECTRICAL SYSTEM WIRE CLAMPS

LIST OF FASTENING CLAMPS FOR F3 675 ELECTRICAL SYSTEM CABLES

Code	Qty.	Length	Name
800092248	9	L = 82 mm	Rubber clamp L 82
800092247	14	L = 62 mm	Rubber clamp L 62
800053724	9(*)	L = 39 mm	Rubber clamp L 39
800092668	6(**)	L = 25 mm	Rubber clamp L 25
800056783	4	L = 142 mm	Plastic clamp for cables
800092661	14	L = 92 mm	Plastic clamp for cables
800056444	5	L = 188 mm	Plastic clamp for cables

(*) Cod. 800053724: Q.ty 10- only for Electrical cable "E" version.

(**) Cod. 800092668: Q.ty 7 - only for Electrical cable F3 Serie ORO

For correct positioning of the electrical wiring on the motorcycle, first insert the main cable connector on the injection control unit as shown in fig. 01.

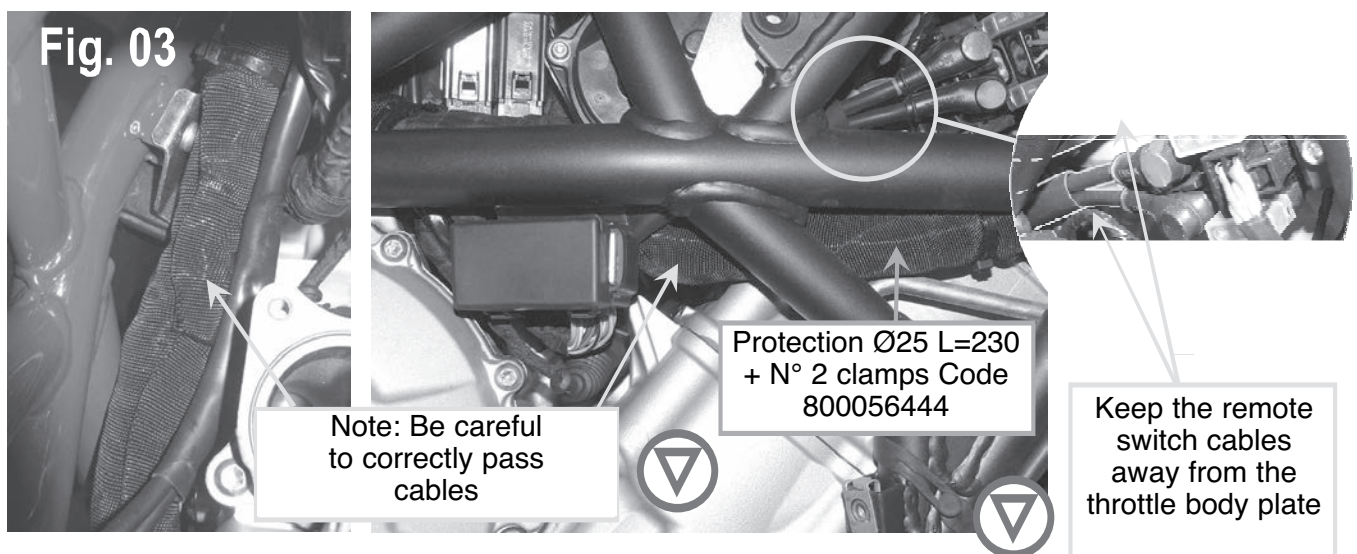
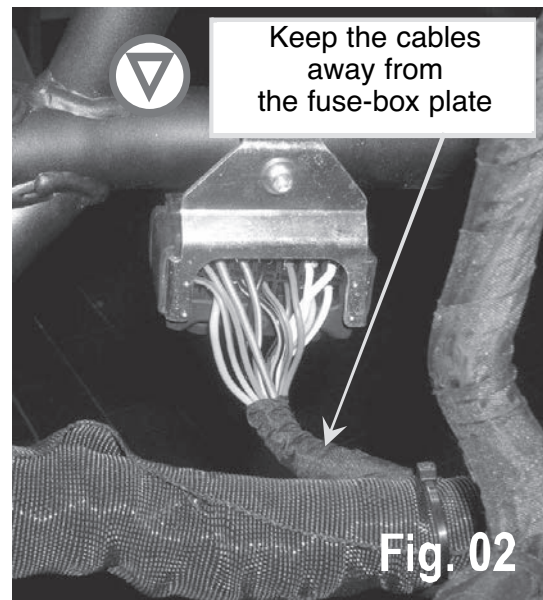
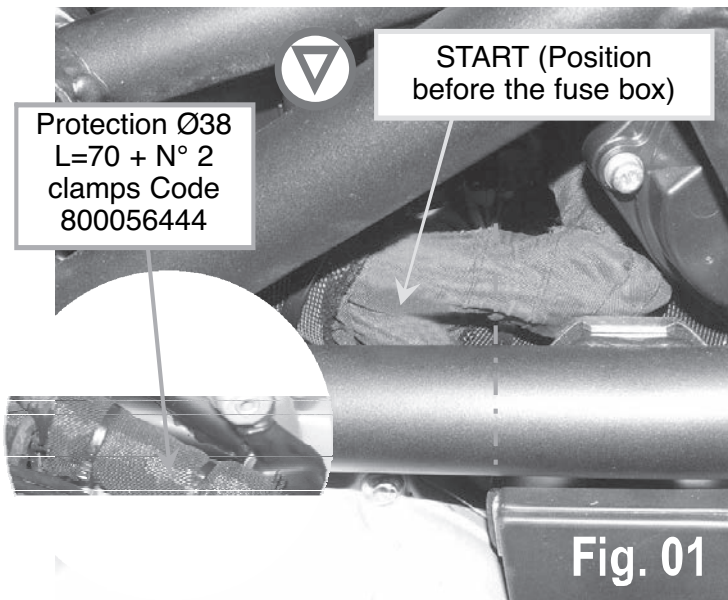



Electrical system

For the position of the clamps for fastening electrical system F3 675 cables, refer to the layout shown below (see figs. 04-30).

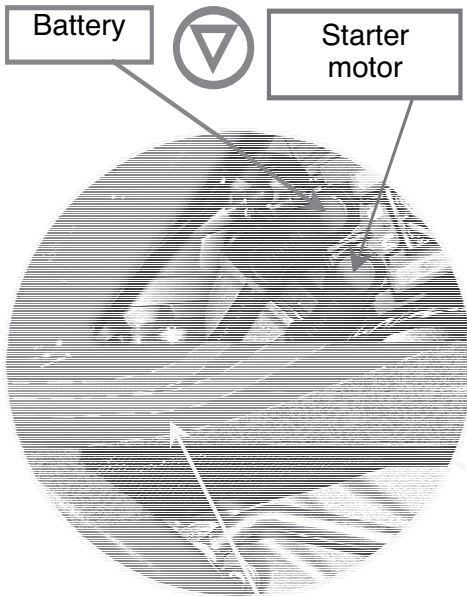

Battery



Starter motor

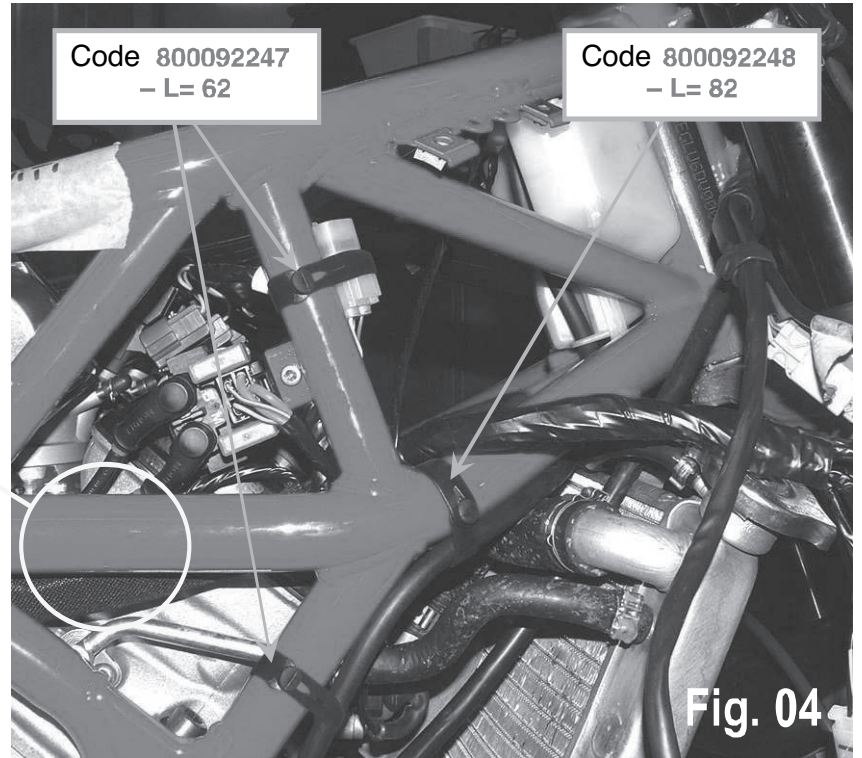

Code 800092247
- L= 62

Code 800092248
- L= 82

Fig. 04



Position the remote switch cables above the cabling of the electrical system

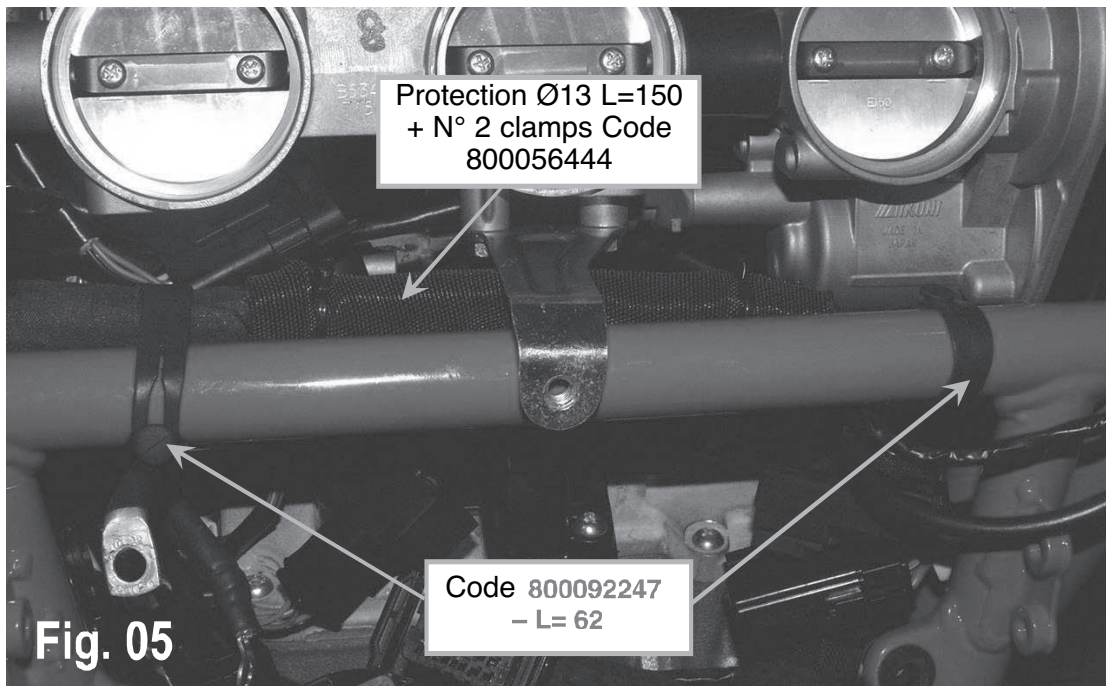

Protection Ø13 L=150
+ N° 2 clamps Code
800056444

Code 800092247
- L= 62

Fig. 05

E

Fig. 06

Code 800053724 - L= 39

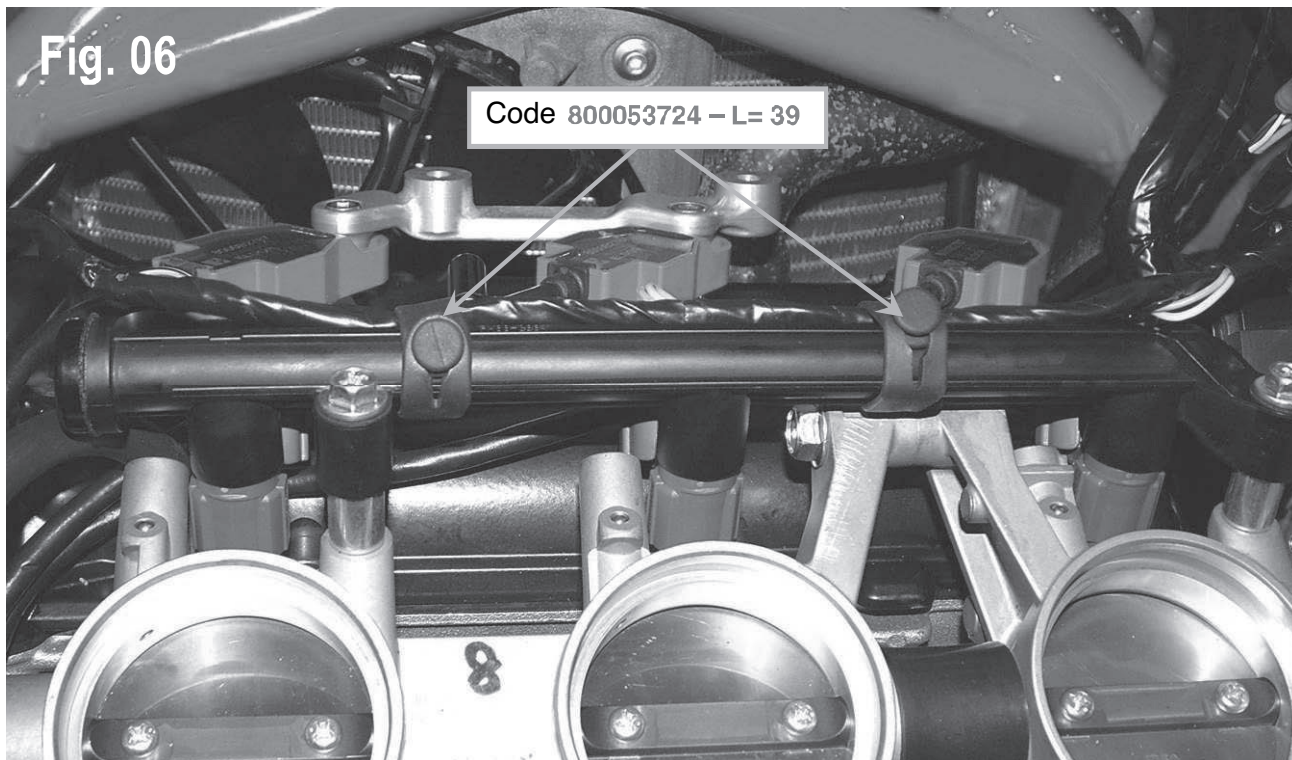
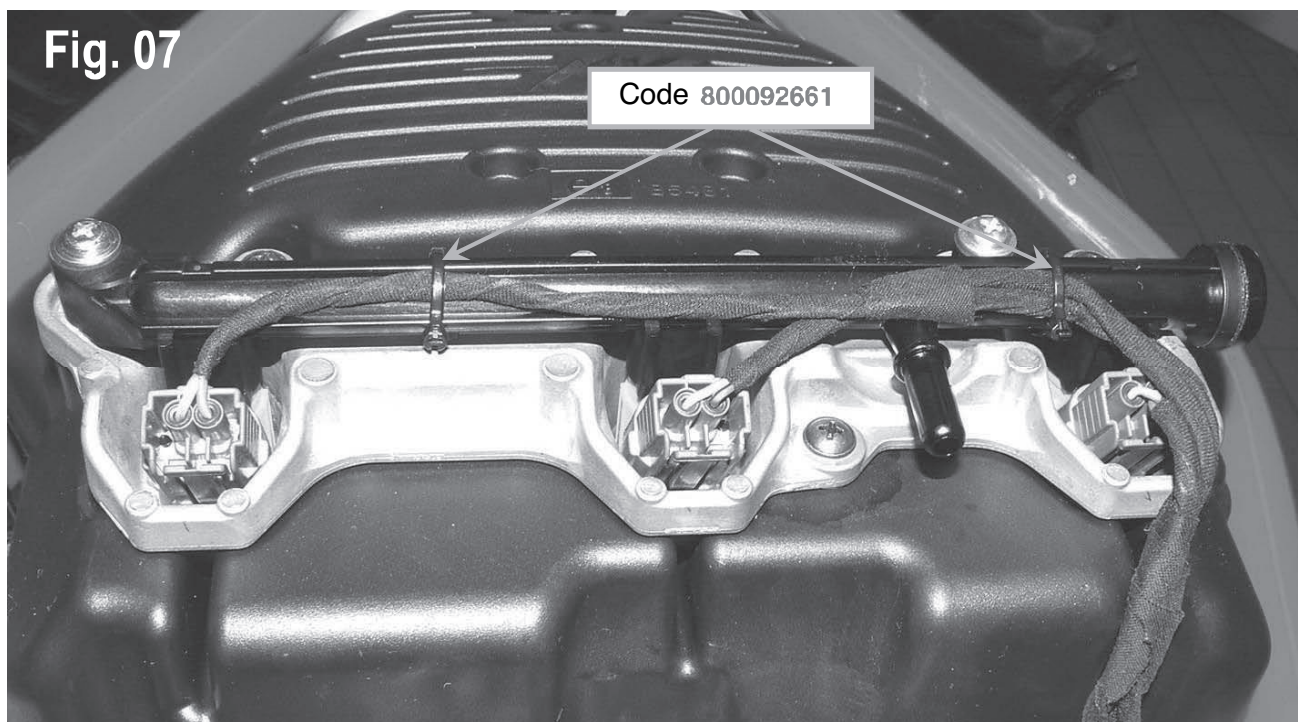
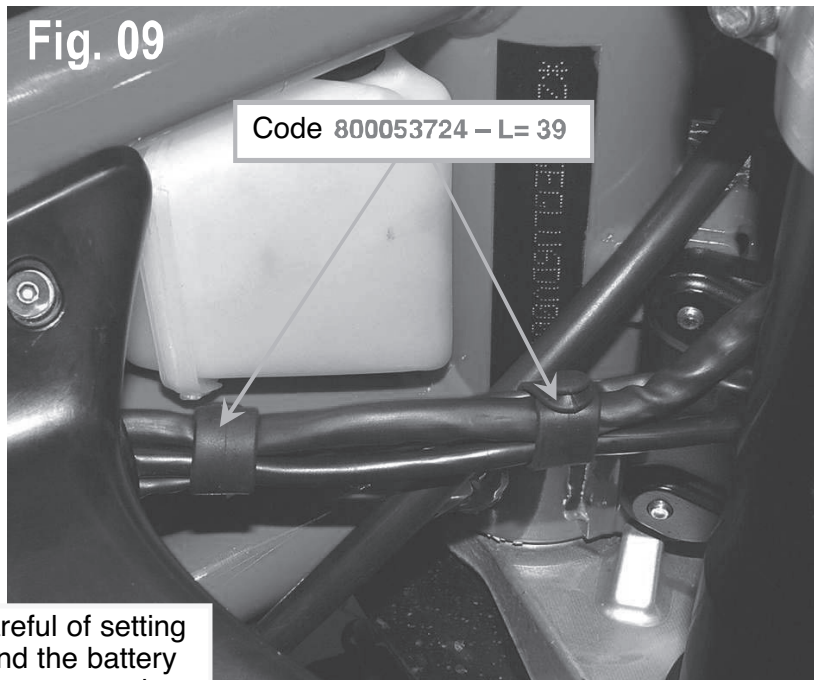
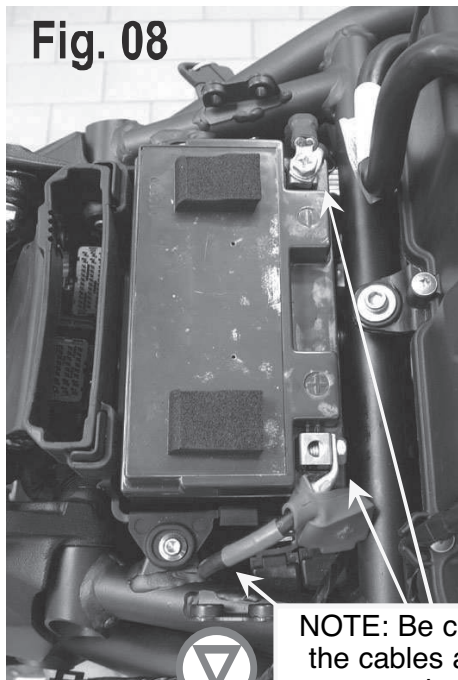

Fig. 07

Code 800092661





NOTE: Be careful of setting the cables and the battery connections up properly

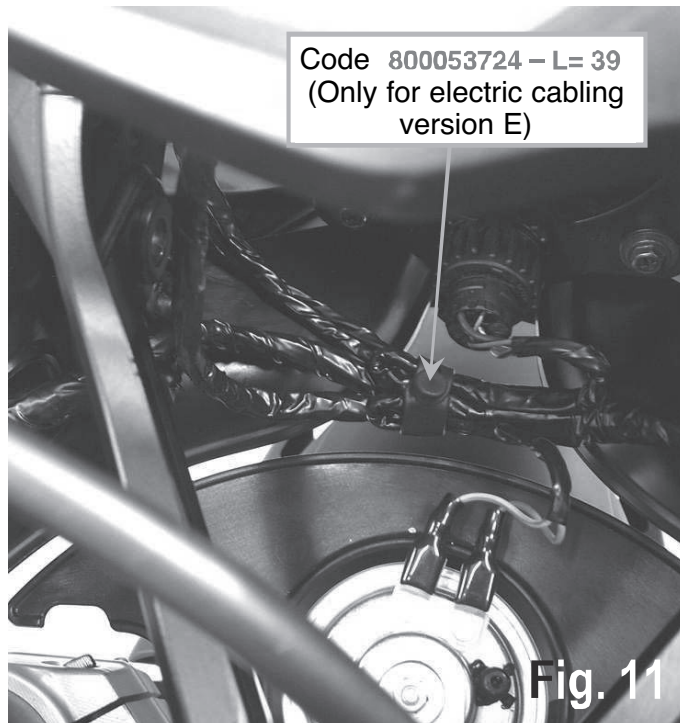
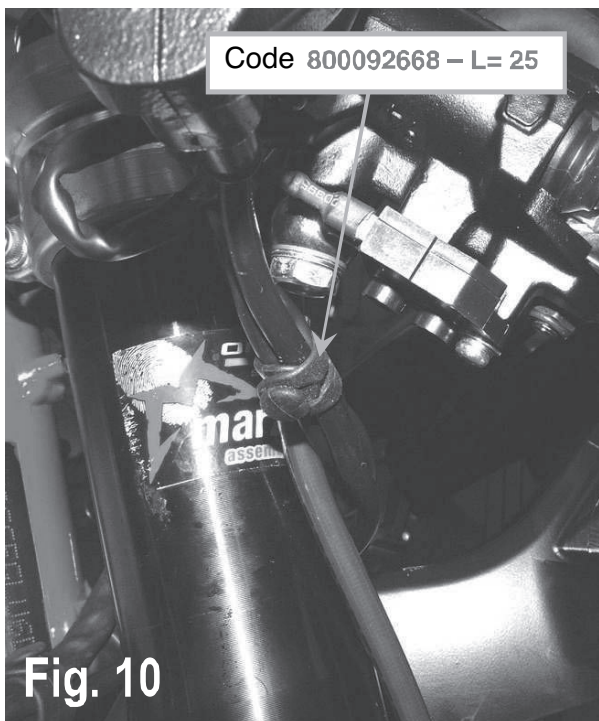

E

Fig. 12

NOTE: Check steering and make sure the horn works

NOTE: Position the cable on the lh side of the vehicle

Code 800092668
- L= 25

Code 800056783

Code 800056783

NOTE: Position the cables under the light

Code 8000B5979

Code 800056444

Code 8000B1534

Code 800092247
- L= 62

Fig. 13

E



Electrical system

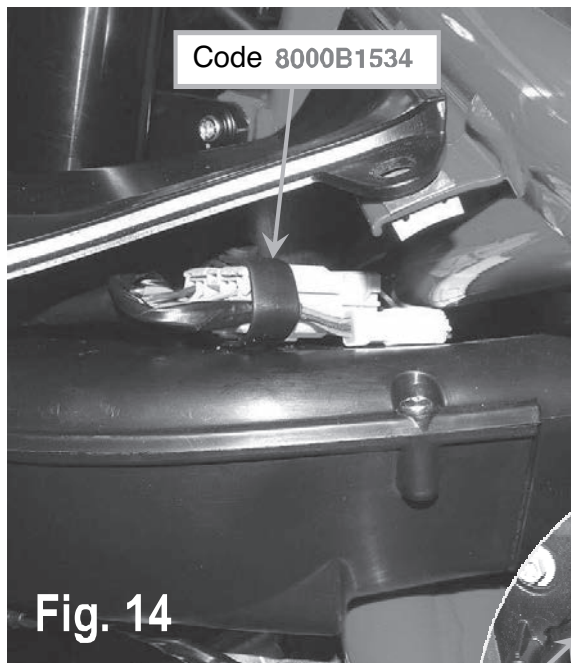

Fig. 14

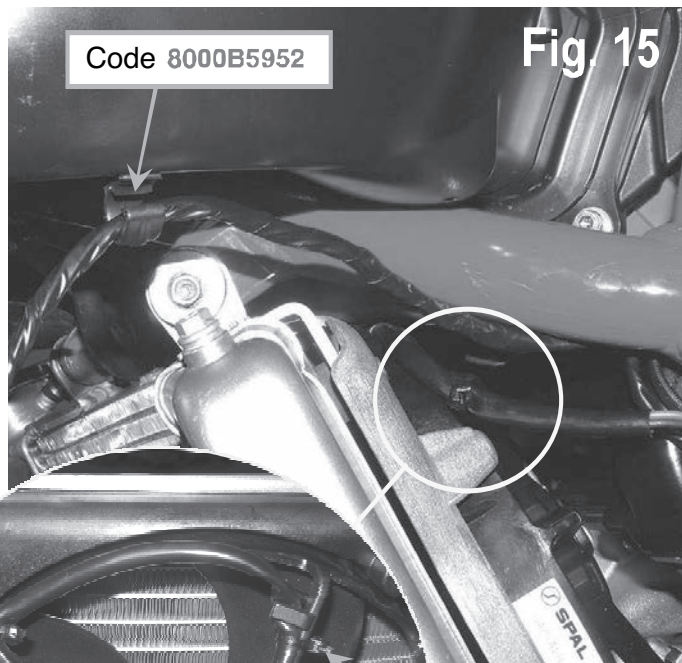
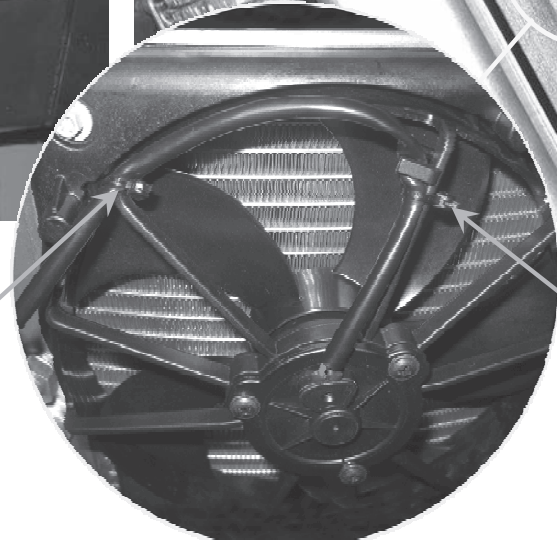

Fig. 15



Code 800092661

Code 800092661

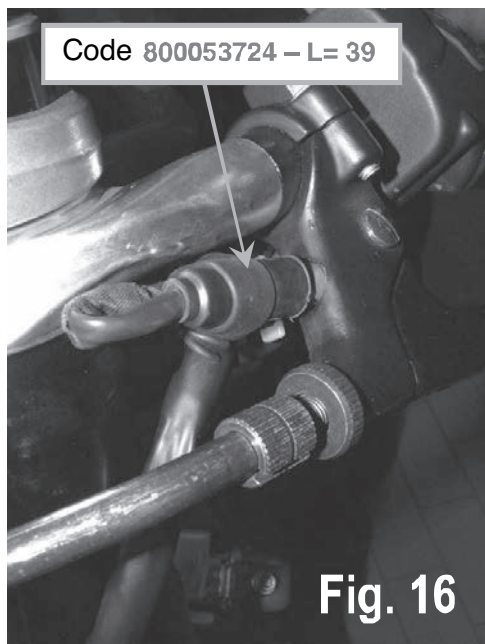

Fig. 16

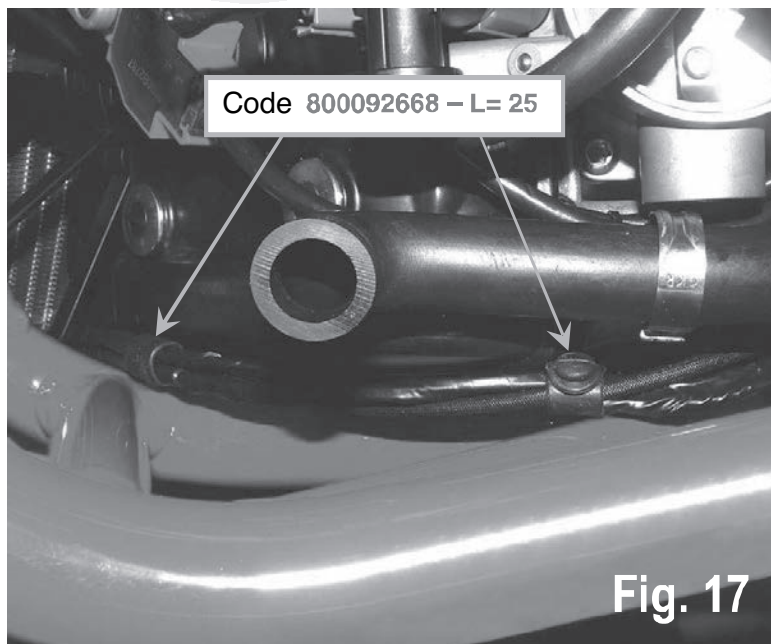
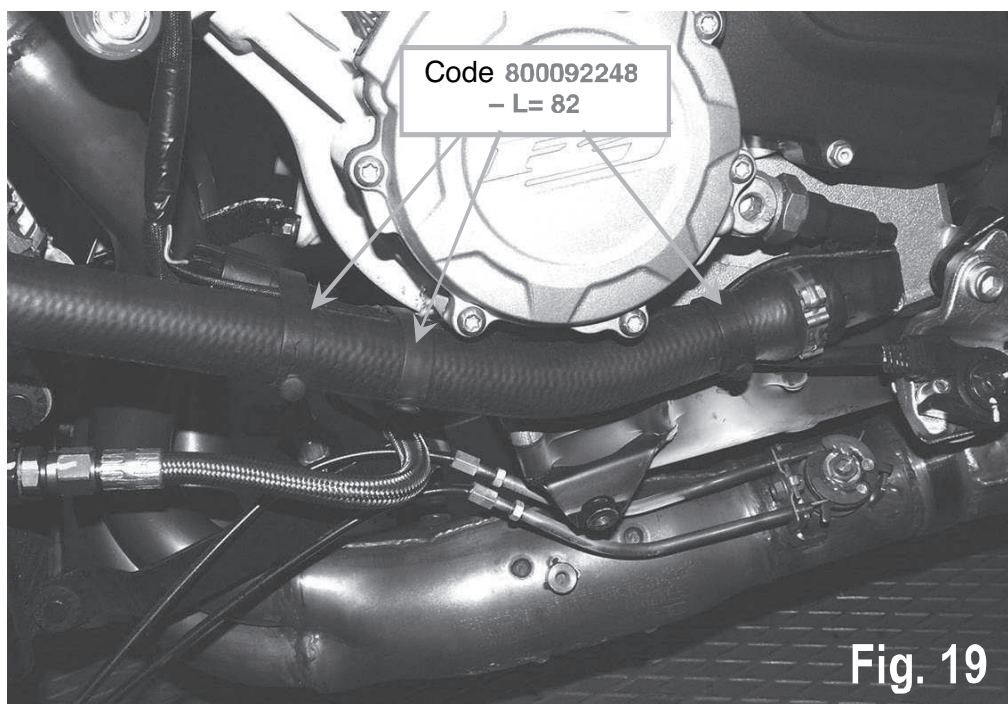
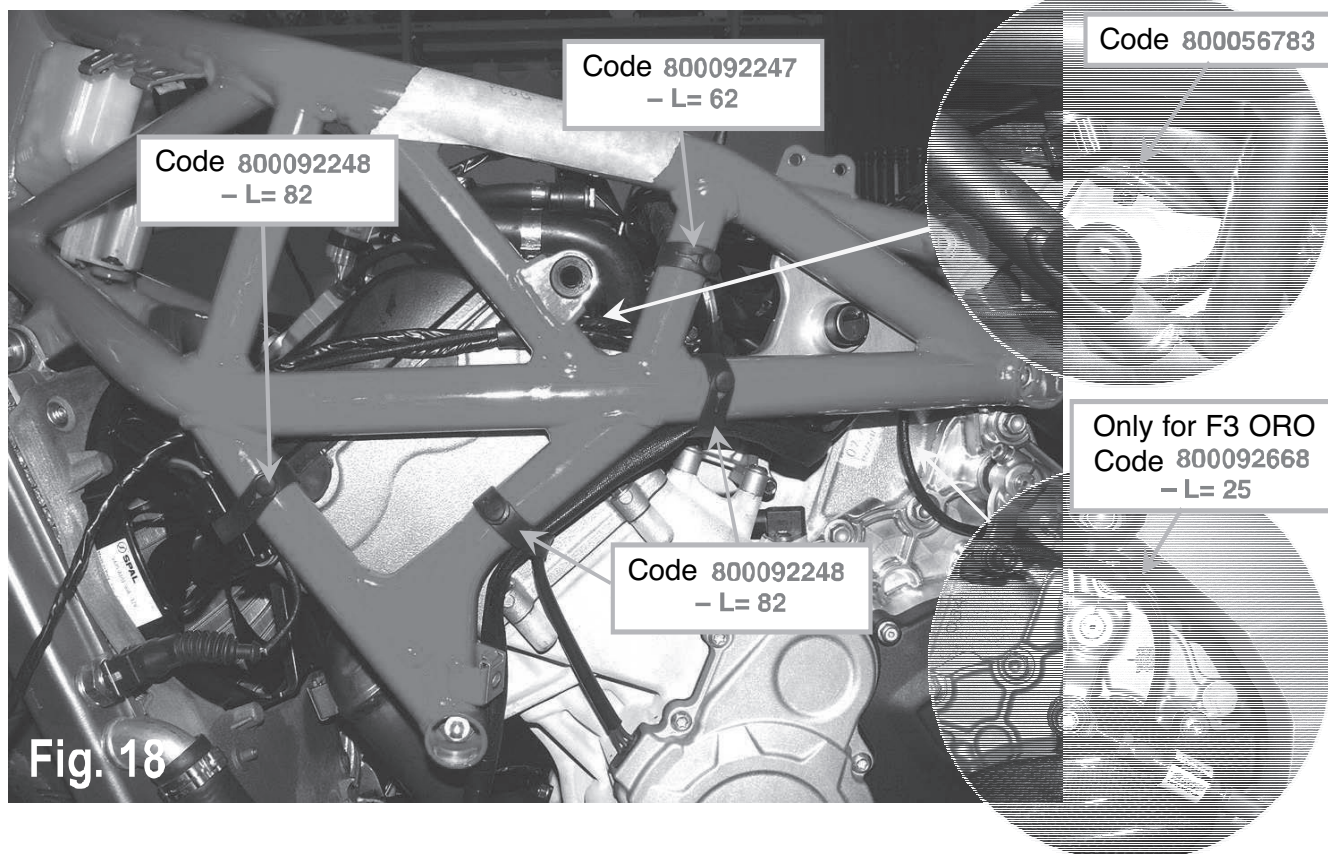
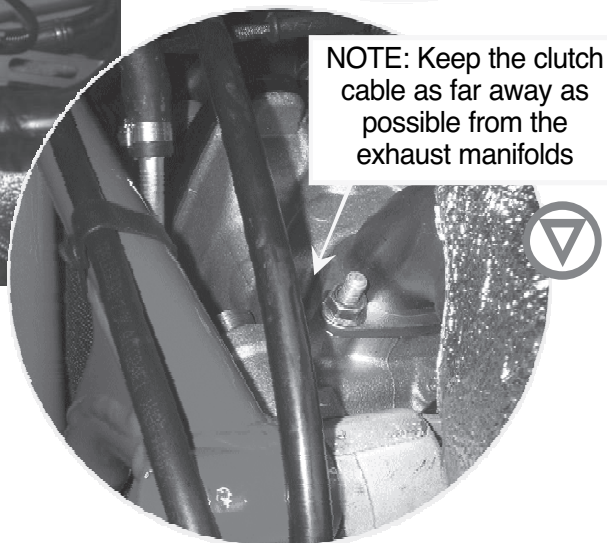
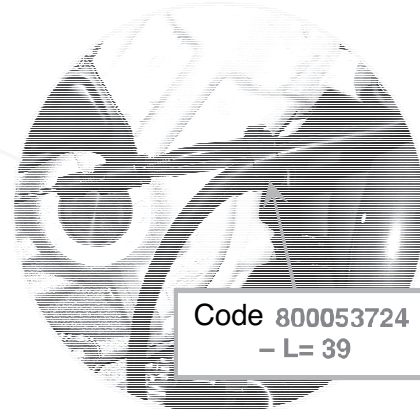
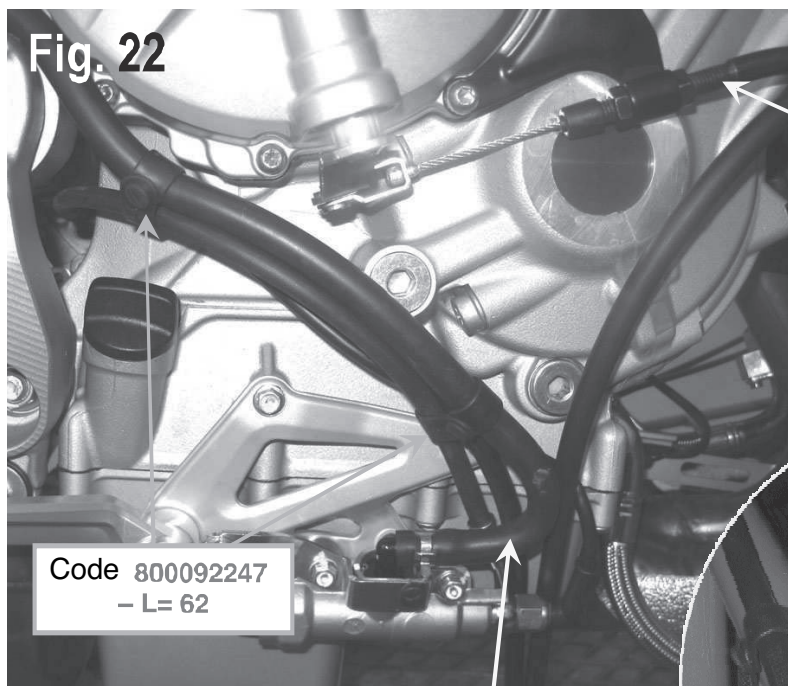
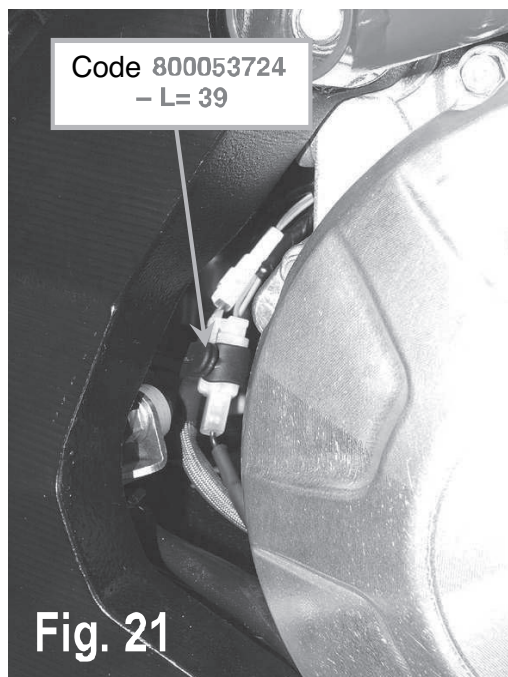
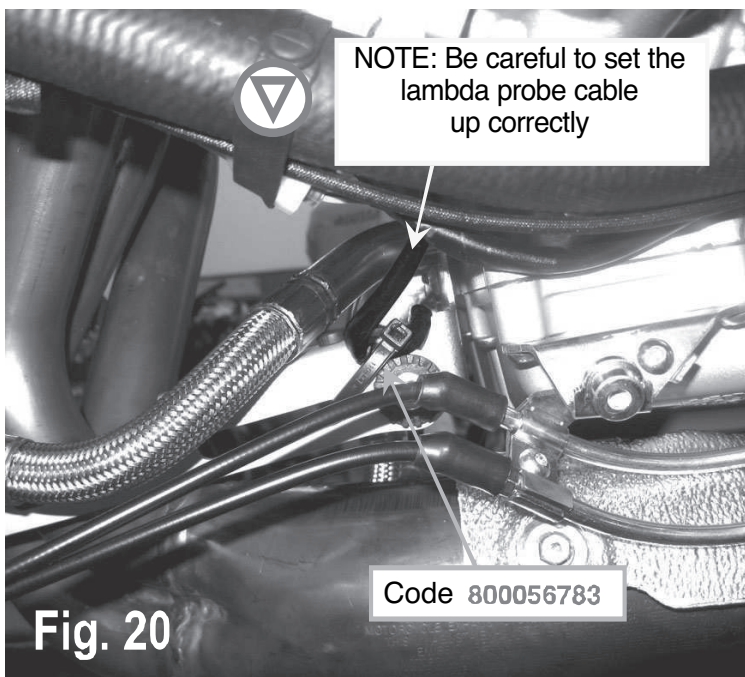

Fig. 17

E





NOTE: Pass the cables behind the rear brake pedal switch cable.

E

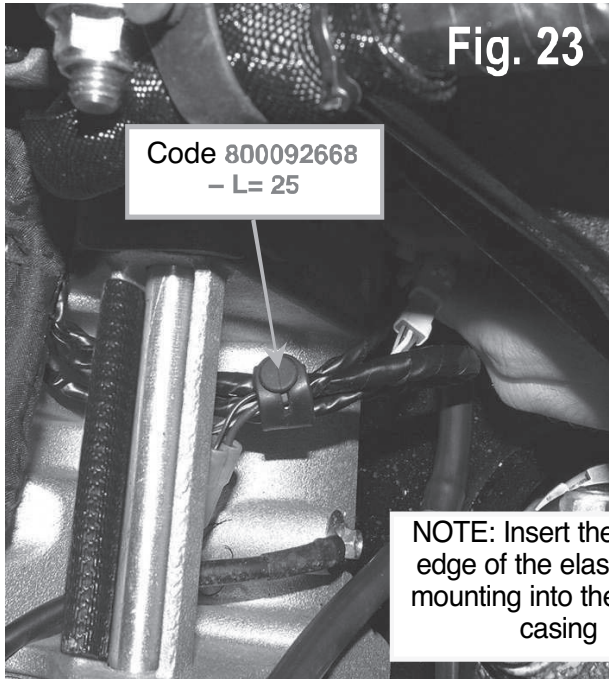

NOTE: Insert the bottom edge of the elastic ECU mounting into the engine casing

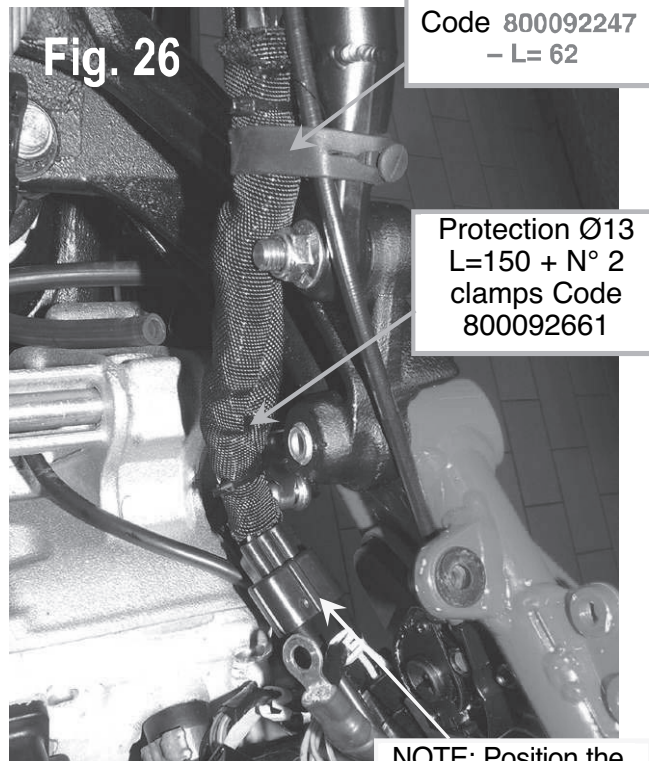
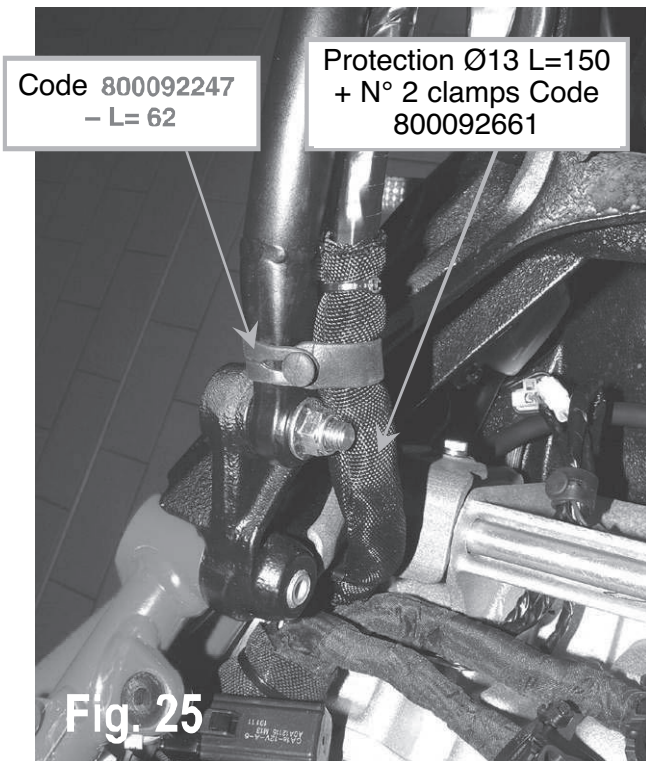

NOTE: Position the connector outside of the guard

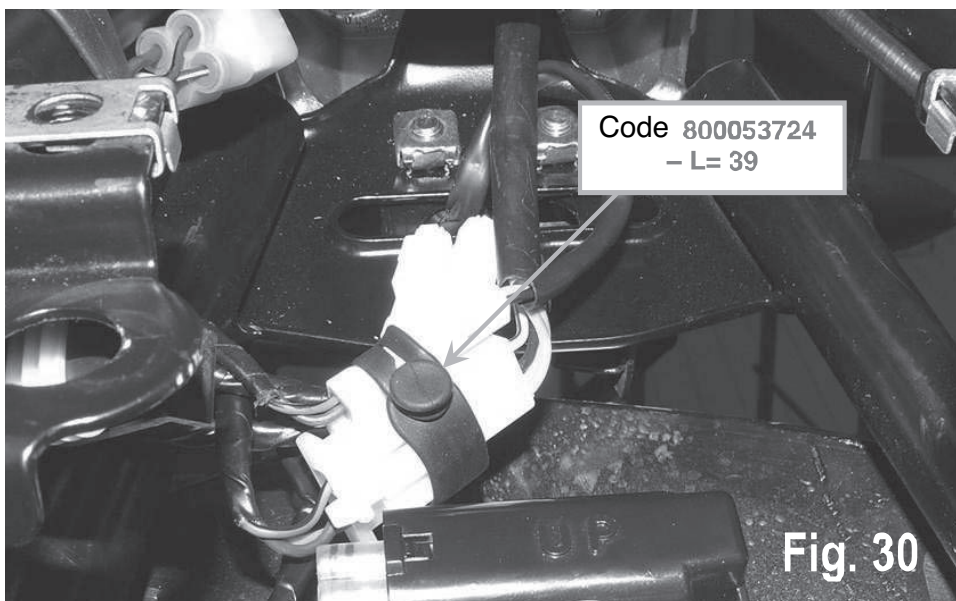
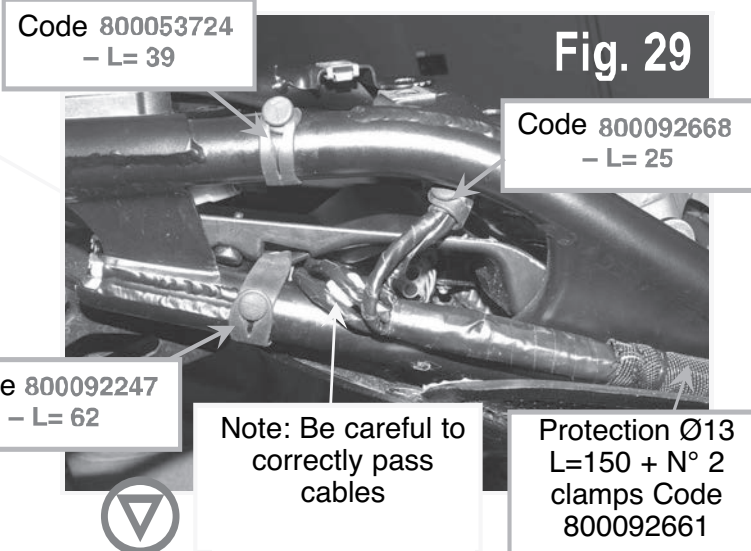
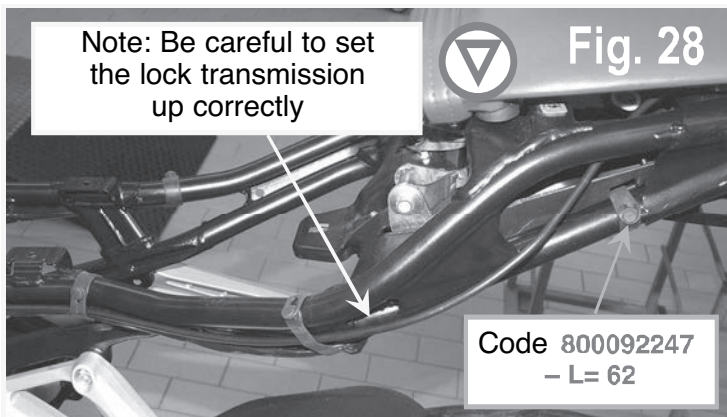

E

E



Fig. 31

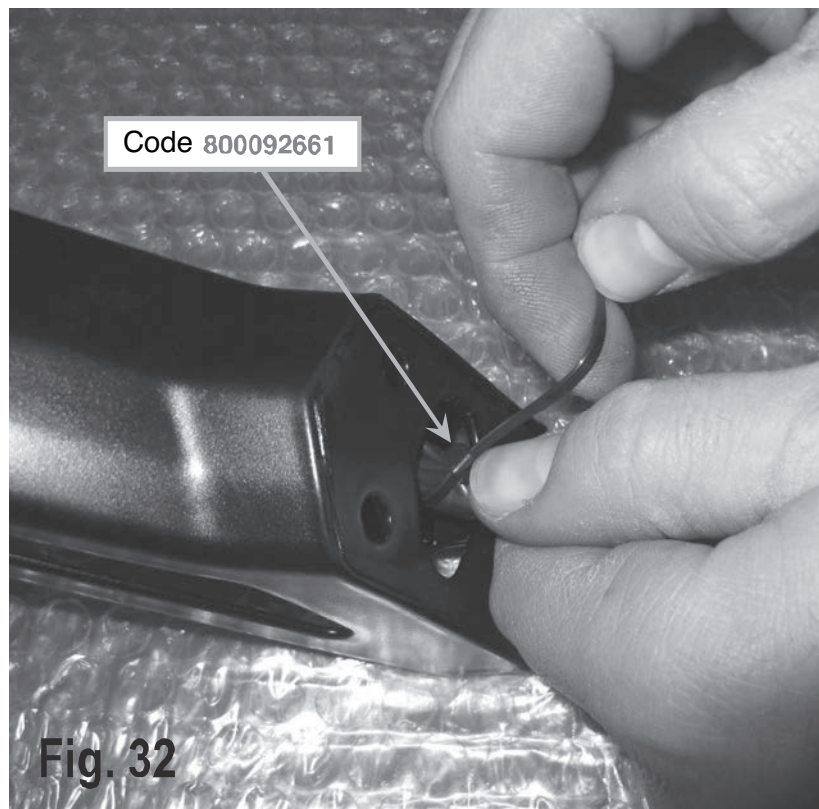
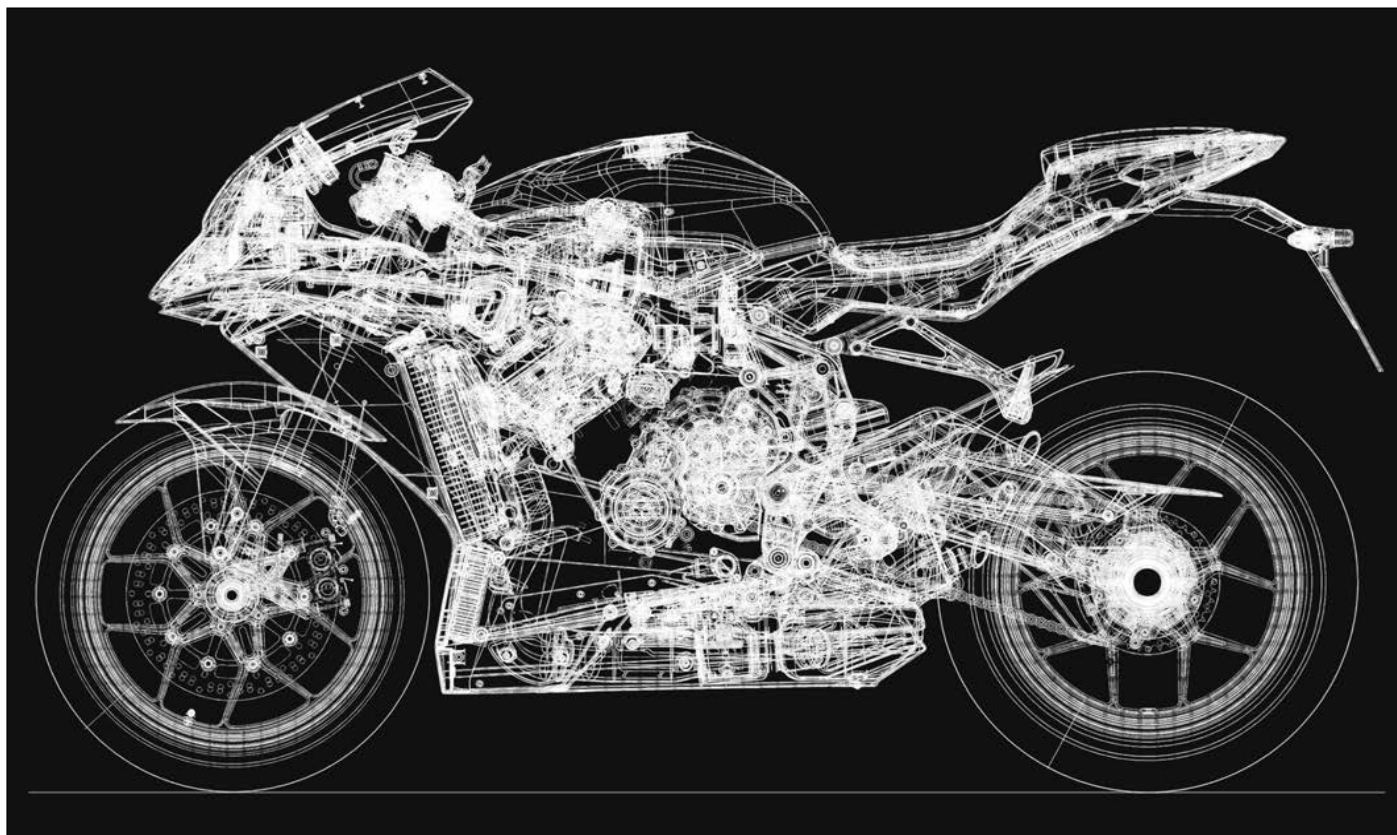

Fig. 32



Suspension and wheels



F

SECTION F

Revision 0



SUMMARY

FRONT WHEEL	PAGE 3
FRONT FORKS F3 675	PAGE 10
FRONT FORKS F3 ORO	PAGE 11
STEERING ASSEMBLY	PAGE 34
REAR SUSPENSION AND SWINGARM	PAGE 45
REAR WHEEL HUB	PAGE 62
MOTORCYCLE SET-UP ADJUSTMENT	PAGE 79
WHEELS - CHECK AND BALANCING	PAGE 81



Suspension and wheels

FRONT WHEEL

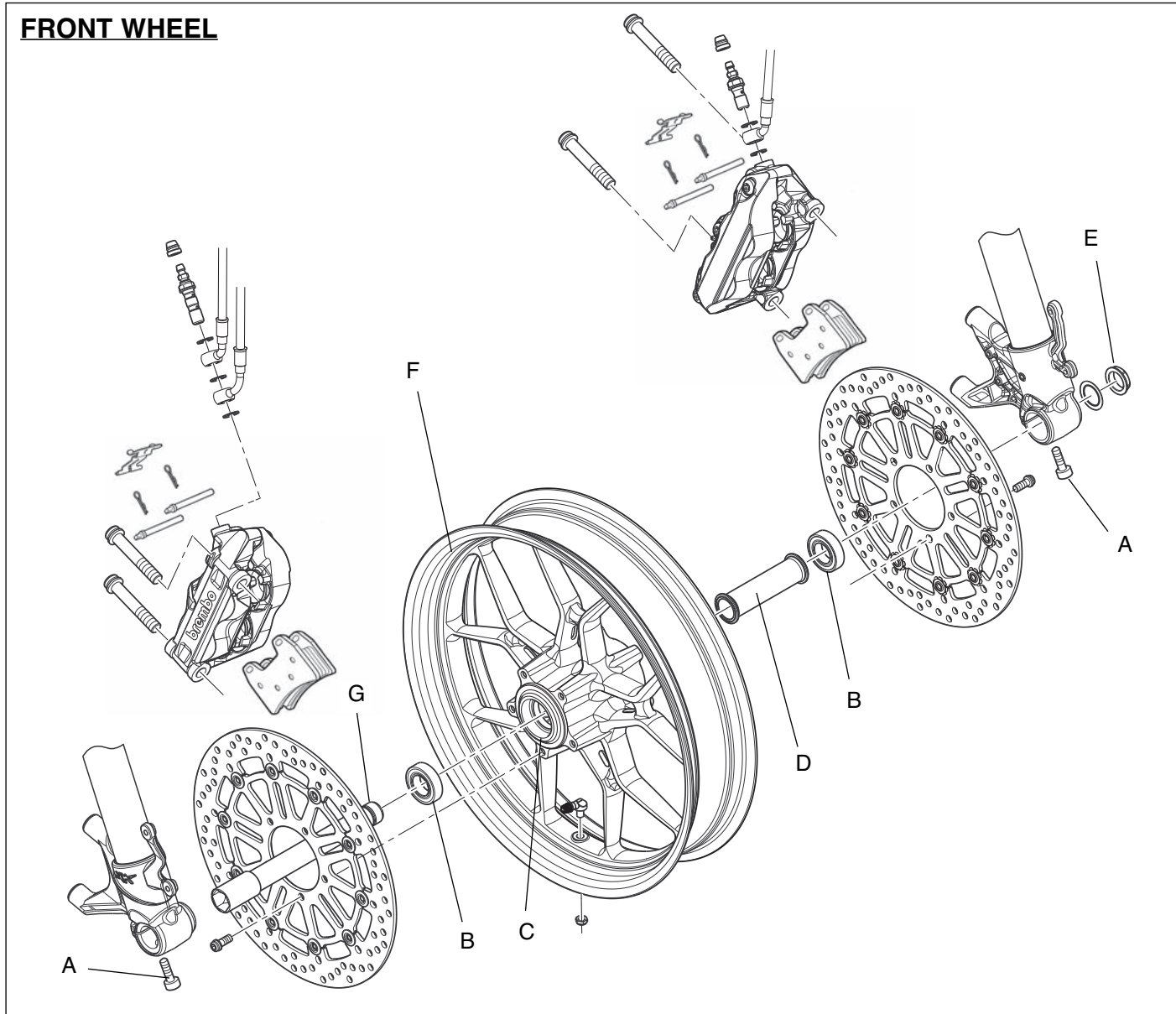

		A		B	C	D	E	F	G		
		F3 675	F3 ORO								
Torque	N·m	16 ÷ 18	19			60					
	Kg·m										
	ft·lb										
Operation											

Description	F3 675	F3 ORO
FRONT WHEEL		
Material	Aluminium alloy	Forged aluminium alloy
Dimensions	3,50" x 17"	
FRONT TYRE		
Dimensions	120/70-ZR 17 M/C (58 W) TL	
Brand and type	PIRELLI - Diablo Rosso Corsa	
Front tyre pressure	2.3 bar (33 psi)	



Sospensioni e ruote

FRONT WHEEL REMOVAL

Place the motorcycle on the rear stand.



Special tool N. 800092642



Front brake caliper removal

Unscrew the two fixing screws of both front calipers and remove the calipers.



Torque pressure: 42 ÷ 46 N·m



Protect the disassembled calipers with protective material thereby avoiding possible damage to the wheel rim.

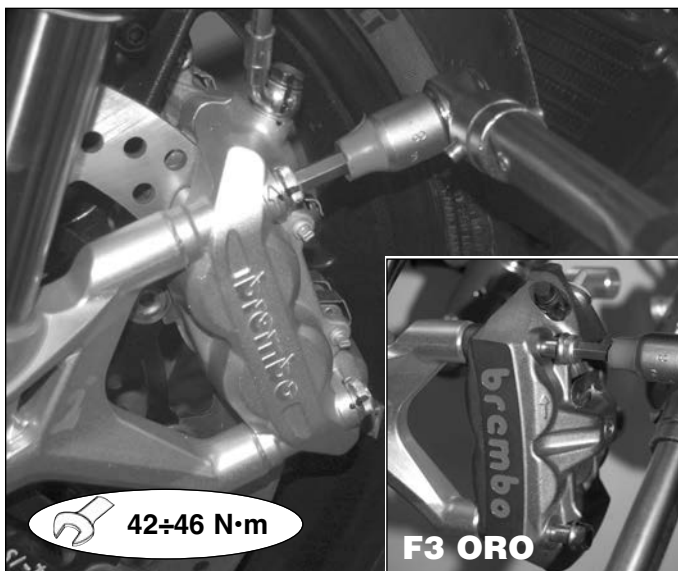

Lift the motorcycle up at the front end.
Mount the special tool that is supplied with a pin on the lower part of the steering base as shown in the figure.
Lift the motorcycle up.



Special tool No. 800095807 and No. 8000B7340





Suspension and wheels

Remove the screw (1) on both front wheel/fork attachments.

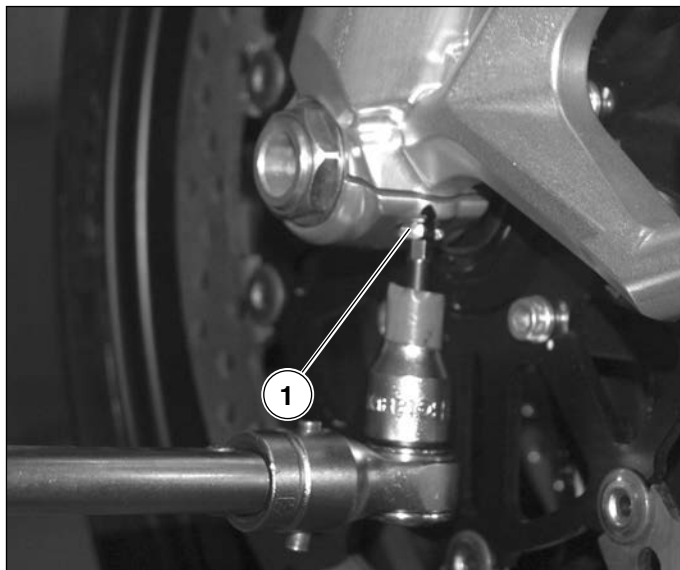

Unscrew the nut from the left side.

Holding the wheel up with your left hand, use your right hand to push the pin towards the right part of the motorcycle.

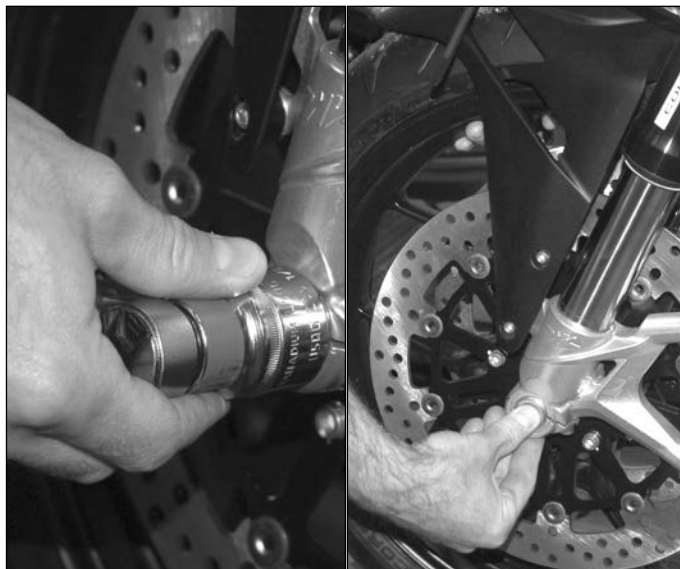

Take the wheel pin out (2) from the right side, freeing up the wheel.

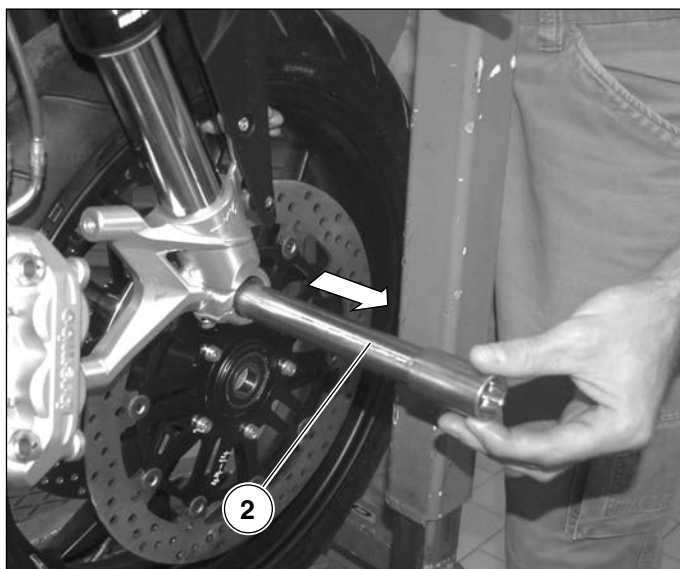

F



Suspension and wheels

Front wheel bearing check

With the wheel spindle still mounted to the wheel, rotate the wheel to check that the bearings are not pitted and rotate with a smooth action. Check also for axial (**A**) and/or radial (**B**) movement. If either condition is verified, substitute the bearings.

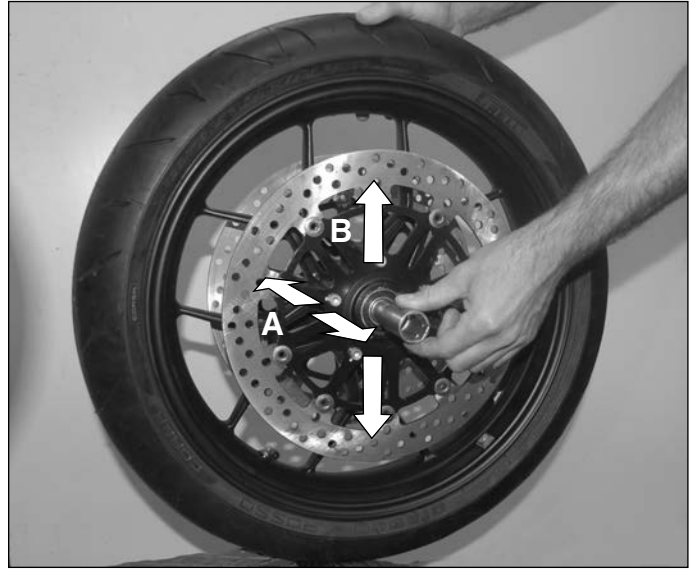

F Utilise the special tool to extract the bearings. To assemble the tool, it is necessary to remove the screw (1) and extract the wheel spindle (2). Remove the nut (3) and then the flange (4).

 **Before substituting the bearings as indicated above it is advisable to remove the brake discs as indicated in chapter H "Brakes" to avoid damaging them.**

 **Special tool N. 8000B4416**

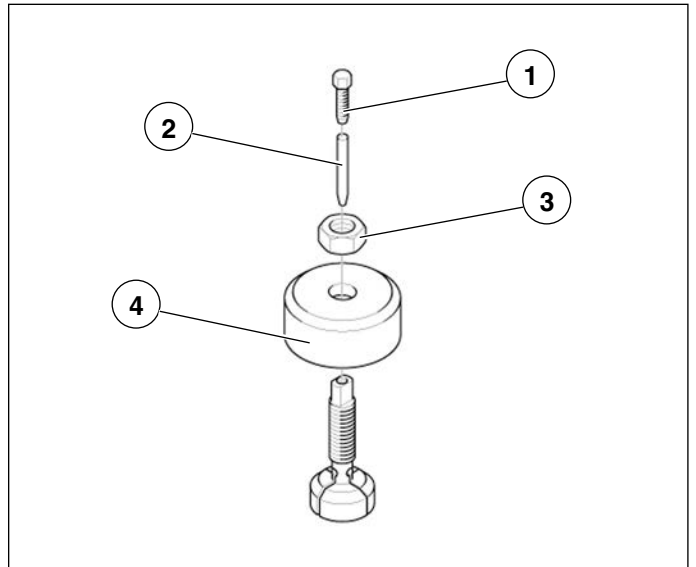

Introduce the extractor until the internal ring of the bearing is hooked up. Introduce the wheel spindle and screw and **block them by means of two 14 mm wrenches.**





Suspension and wheels

Mount the flange, spacer ring and nut utilising a 14 mm spanner and a 27 mm spanner and extract the bearing as shown in the figure.

NOTE Operate in the same way on both bearings.



Check that the ends of the aluminium spacer and the seats of the bearings on the wheels are not scored or marked.



Reassembly – front wheel bearings

Before proceeding with the reassembly, accurately clean the bearing seats in the wheel hub.

Lubricate the outer ring of both bearings with special grease.

Mount the bearing on the specific tool and insert it in the rim housing.



Recommended product: Agip Grease 30



Special tool No. 8000B4421

Mount the bearing and a spacer on the specific tool.



Special tool No. 8000B4421





Suspension and wheels

Insert it on the opposite part, keeping the rim in a vertical position.

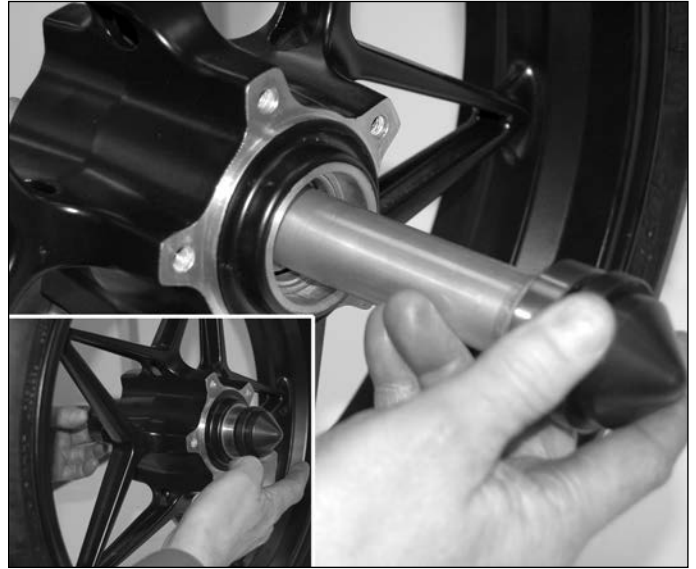

F Insert the guide spacer and utilising a press, squeeze down the bearings.



Proceed as illustrated in the figure.

 **Attention: the wheel bearings should be mounted with little interference but should the action of the press be blocked in any way, release the press.**

Having completed the assembly, check that the aluminium spacer does not have axial play. Assemble the wheel spindle and carry out again the rolling check by rotating the wheel.

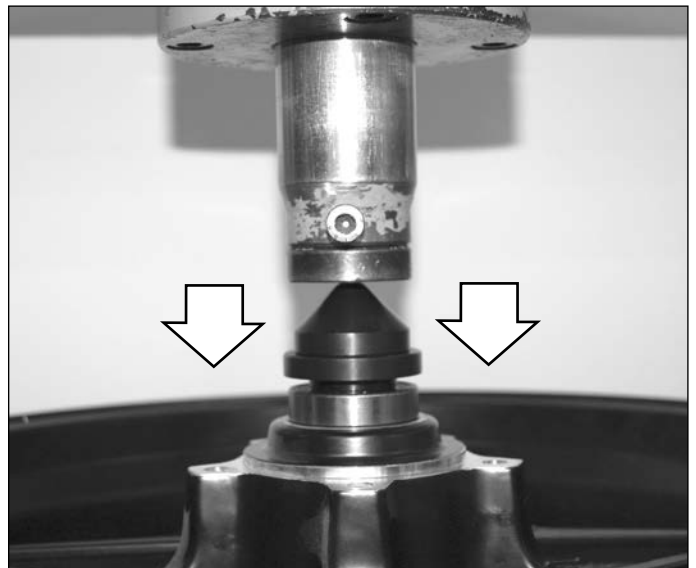

Wheel spindle check

Place the wheel spindle on two v-prisms on a flat surface.



Utilising a dial gauge, check that the **eccentricity in the central part does not exceed 0.05 mm.**



Wheel assembly



If the front tyre is substituted, before assembling the wheel it is necessary to balance the wheel following the indications in page 81.

After having carried out the check on the parts of the front wheel, accurately clean the wheel spindle and assemble it from right to left. Once the wheel has been put back on the vehicle, re-install the nut with washer and tighten it to the required torque..



Apply grease only to the first threads.



Torque pressure: 60 N·m

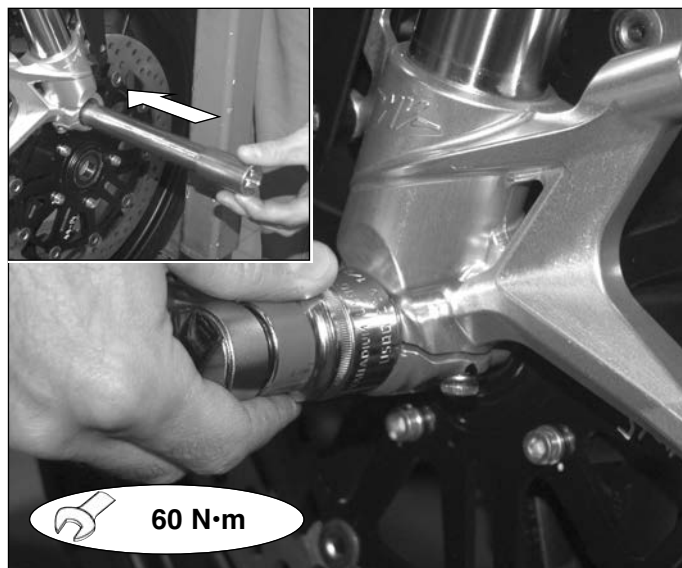

Tighten the 2 screws of the fork feet to the required torque

Mount the two brake calipers as described in chapter H "Brakes".



Torque pressure: F3 675 16 ÷ 18 N·m
Torque pressure: F3 ORO 19 N·m

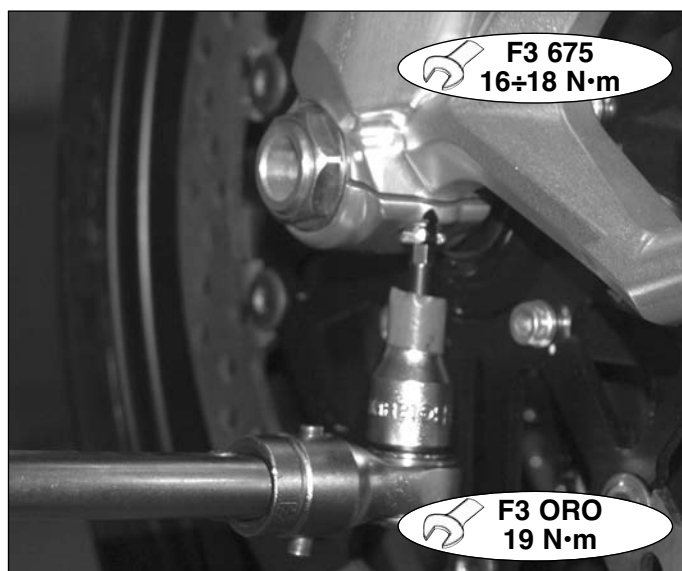

FRONT FORK F3 675

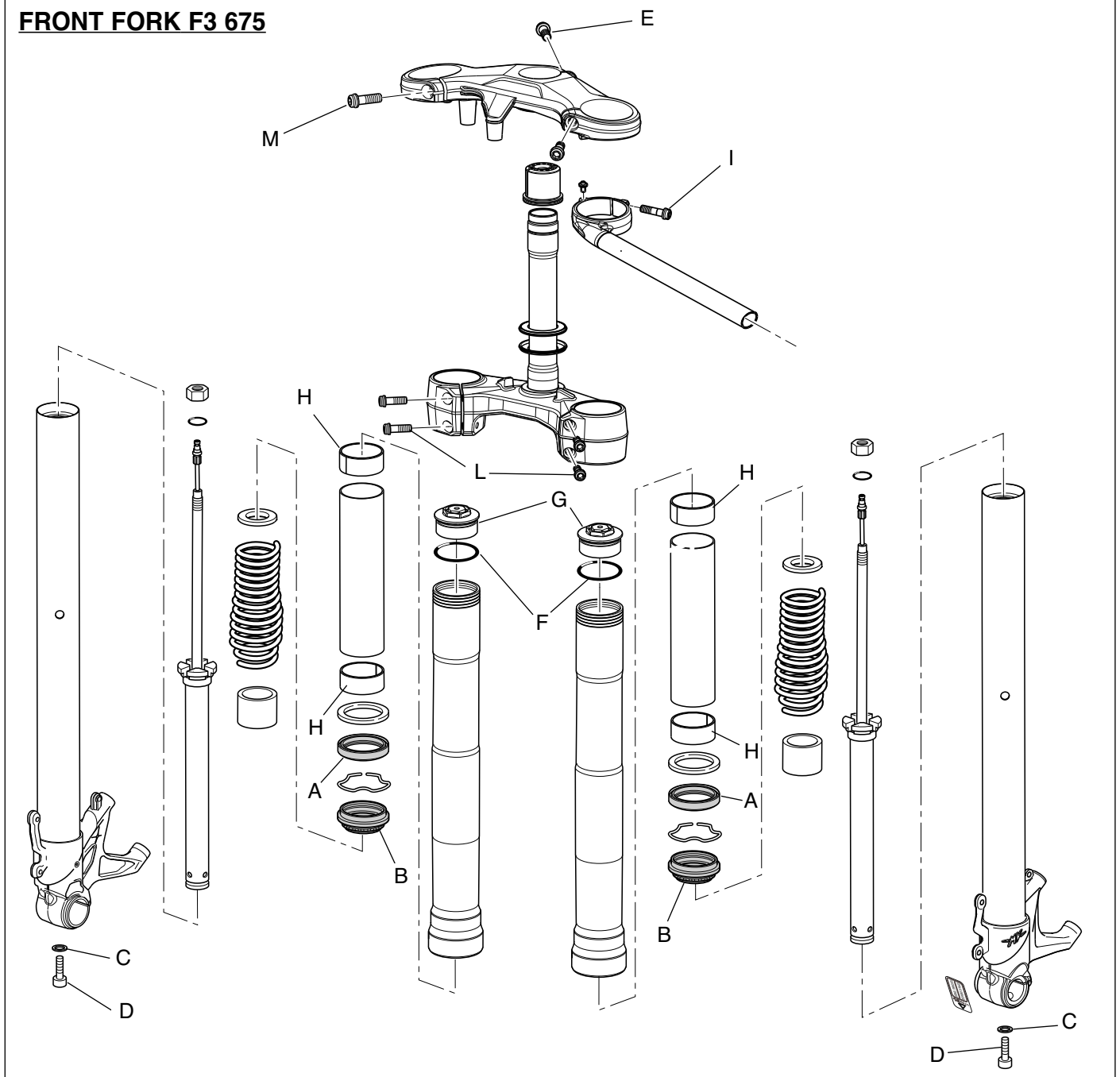

		A	B	C	D	E	F	G	H	I	L	M		
Torque pressure	N·m				35	22 ÷ 24		20		8 ÷ 10	18	16 ÷ 18		
	Kg·m													
	ft·lb													
Operation														

Description	F3 675
FRONT SUSPENSION	
Type	"Upside down" telescopic hydraulic fork with external and separated adjustment of rebound and compression damping and of spring preload
Ø stems (mm)	43
Telescopic movement (mm)	125

FRONT FORK F3 ORO

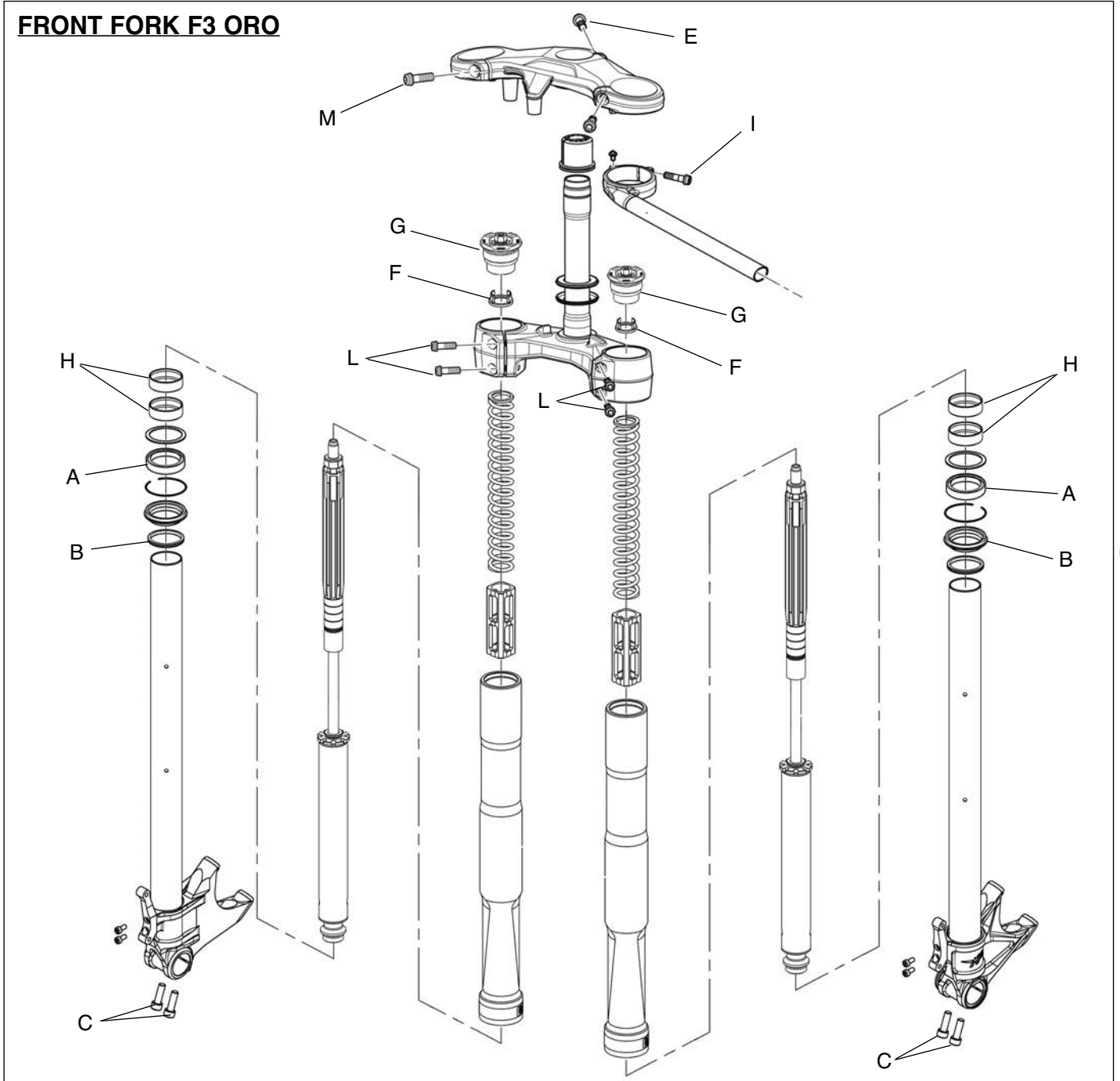

		A	B	C	D	E	F	G	H	I	L			
Torque pressure	N·m			19		22 ÷ 24		20		8 ÷ 10	18			
	Kg·m													
	ft·lb													
Operation														

Description	F3 ORO
FRONT SUSPENSION	
Type	"Upside down" telescopic hydraulic fork with external and separated adjustment of rebound and compression damping and of spring preload
Ø stems (mm)	43
Telescopic movement (mm)	120



Suspension and wheels

FRONT FORK OVERHAUL

Before removing and overhauling the front suspension components, it is advisable to remove the lower fairing, the left and right fairings, the front cowl, the left and right air intake duct covers, the air ducts, the front mud-guard as described in detail in the chapter "Fairings".

Support the motorcycle by the rear stand with special tool.

 **Special tool No. 800092642**



F Remove the front wheel as described in the chapter "FRONT WHEEL" for the vehicle model.

Remove the fixing screw (1) of the holding clamp (2) of the brake line.

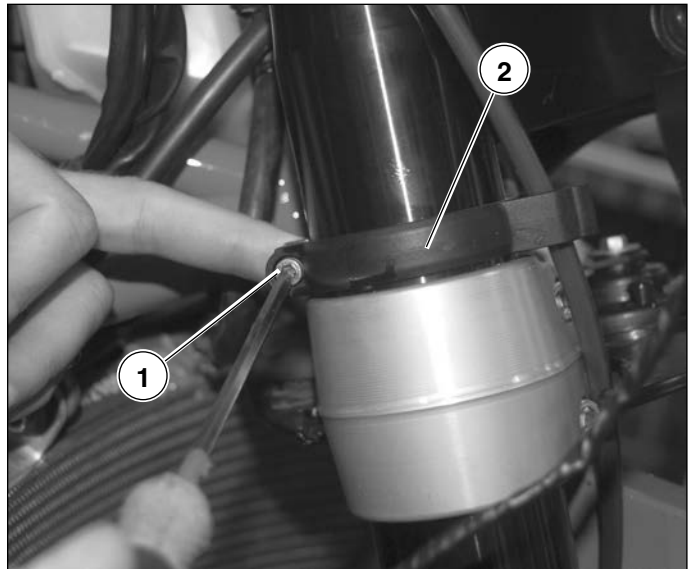

Open the clamp (2) on the front brake pipe and slide it off.

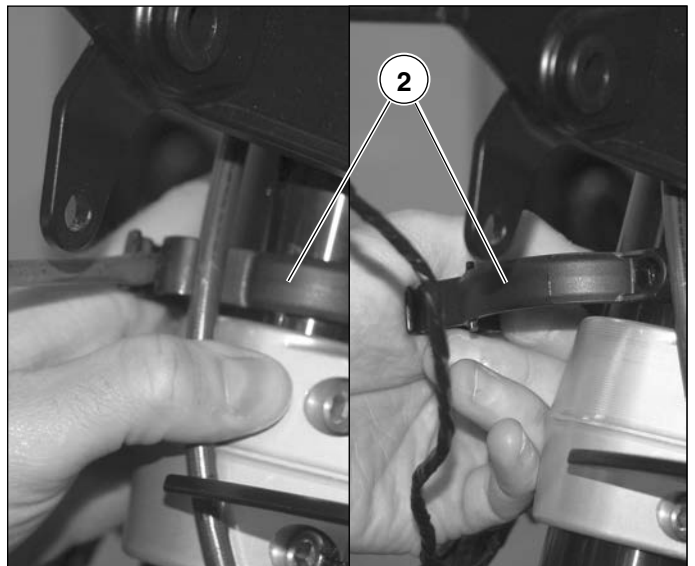

Slacken the screw (1) on the left clip-on handlebar.



Stem removal

Loosen the 2 screws (2) from the steering base and the screw (3) from the steering head.

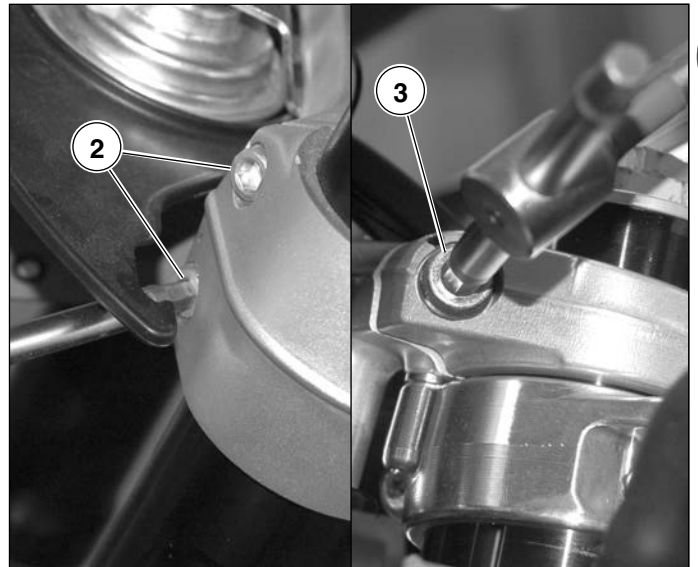

Slide the stem off while holding up the clip-on.





Suspension and wheels

Fasten the clip-on to the steering head using a clamp.
Do the same to disassemble the right stem.



F To make it easier to loosen the screw on the right side steering head, remove the screw that holds up the front brake fluid tank beforehand.



Fork tube exploding (F3 675)

Loosen the spring pre-load adjuster until you feel it reach the end.

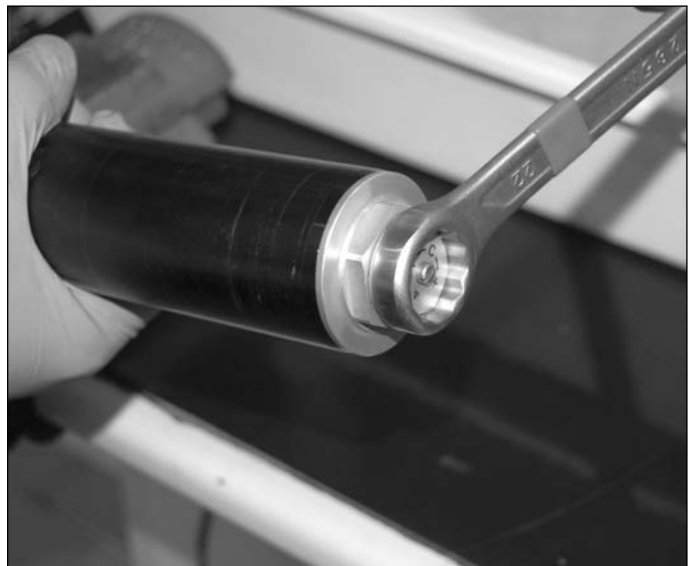



Suspension and wheels

Loosen the cap by approximately 1 turn.



Place the fork leg in a vice, in a vertical position taking care to protect its surface against possible damage.

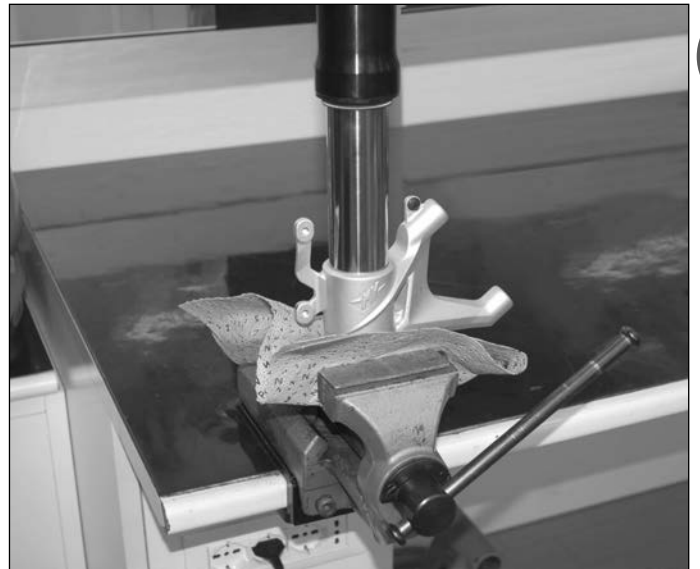

F

Completely unscrew the plug and lower the sheath as shown in the figure. Perform this operation while holding the leg in a vertical position.





Suspension and wheels

Unscrew the plug. Using the spanner, adjust the spring preload while locking the nut on the damping piston rod.

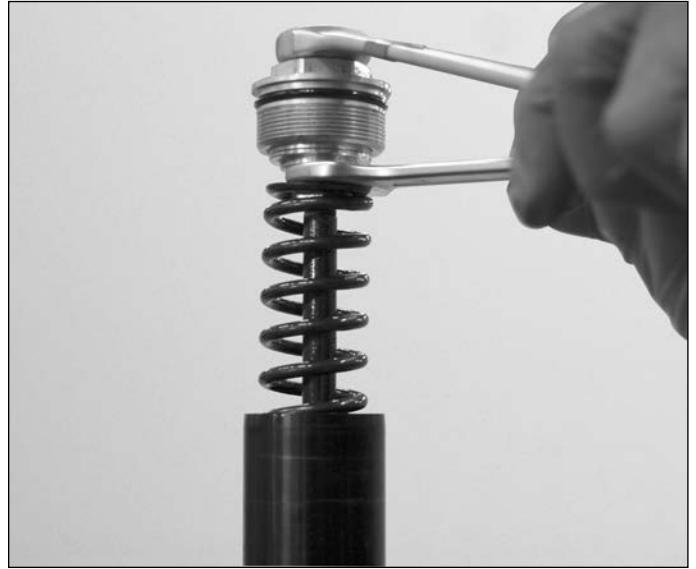

Remove the plug (1).

F

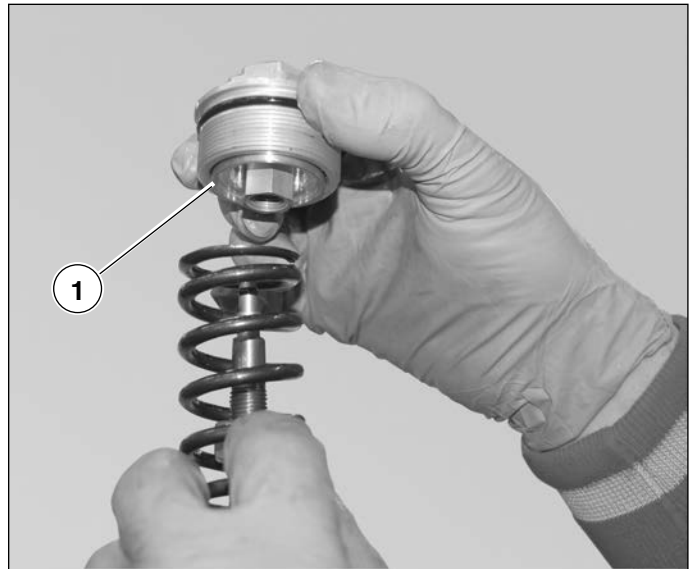

Remove the spring.





Suspension and wheels

Turn the stem upside down and completely pour out the oil into a suitable container.

 **Recover the oil in an appropriate container. Do not dispose of the used oil in the environment.**

During this phase also take the spring pre-load spacer out (1).

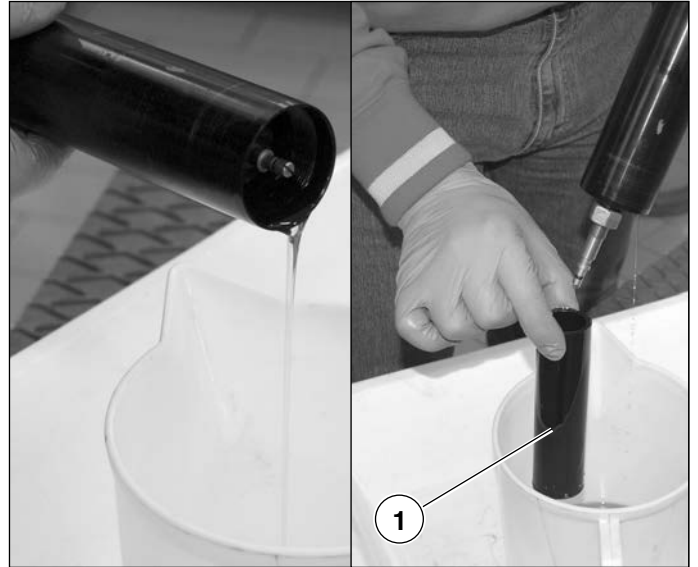

Separate sleeve and stem by pulling along the axis.



Remove the central lower screw that fixes the damping piston. Keep the sealing washer underneath.

 **When refitting, tighten at 35 N·m.**

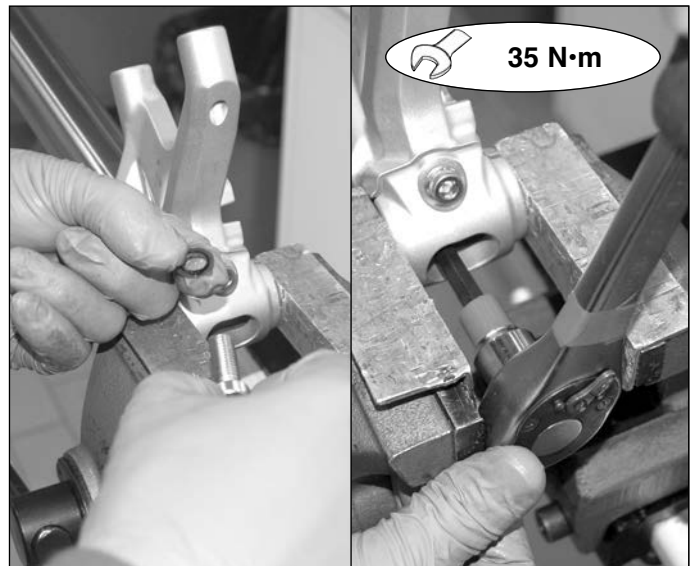



Suspension and wheels

Pull out the damping piston.

Take care not to reverse the pumping elements on the fork while fitting it back in, and configure as follows:

- Brake-pressing pumping element: fit on left leg.
- Brake-releasing pumping element: fit on right leg.

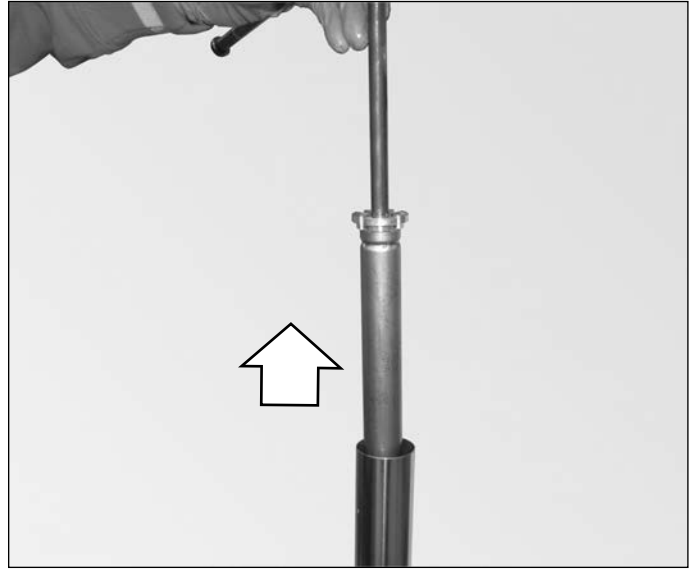

F Remove dust cap (1), taking care not to damage the seat on the sheath.



Remove the retaining ring (2) with a screwdriver.



Extract the oil seal.



Fork assembly check

Check that the sleeve does not have marks on the external part that could have repercussions inside the assembly. Ensure that the inside is completely smooth, without any scratches.

If necessary, substitute with a new part.

Check for marks or scratches on all surfaces of the stem and check the condition of the chroming.

 Measure the length of the spring and compare with the following values:
- **F3 675:** **240 mm**

To replace the bushings inside the sleeve, operate using the required tool in accordance with the method described in the diagram.

 **Special tool No. 8000B6871 (disassembly)**
Special tool No. 8000B6785 (reassembly)

Assembly oil seal and anti-dust seal

After having carefully checked all components, substitute those damaged and/or deteriorated.

Grease the lips of the new anti-dust seal (1) and the new oil seal (2) with the appropriate grease.

 **Recommended grease: MOLYKOTE 55M**

Make sure that the bushings and washer placed against the oil seal are inside the sleeve. Proceed with re-assembly of the oil seal using the required tools.

 **Special tool No. 8000B6785**

Install the dust seal and oil seal on the stem.

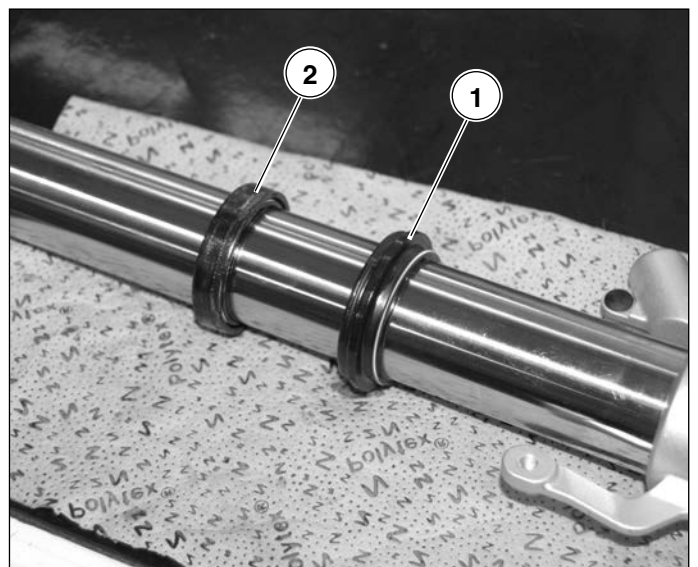
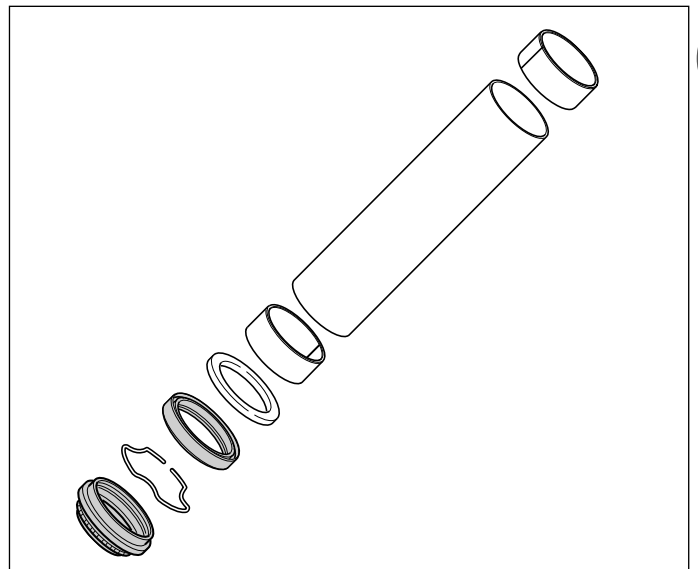



Suspension and wheels

Visually check for scratches and marks on the pump rod and check that it slides smoothly inside the pump unit without chamfering.
Substitute if necessary.

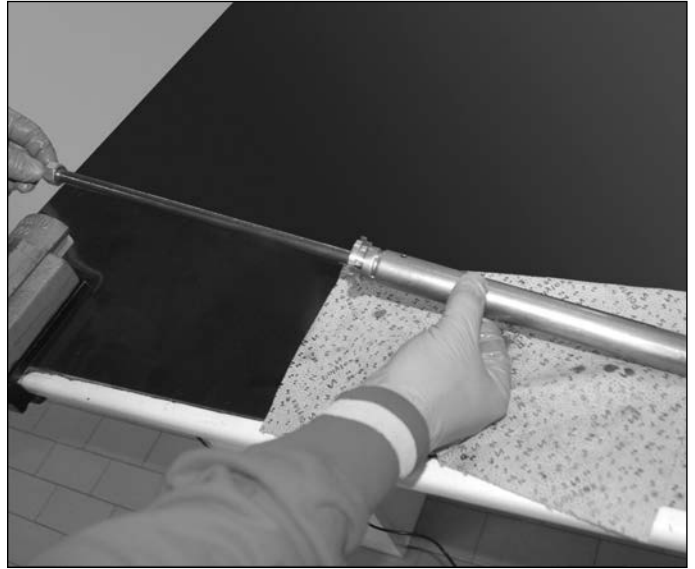

F Insert the pump into the stem and fasten it on with the relative screw.

 **Tighten at 35 N·m.**

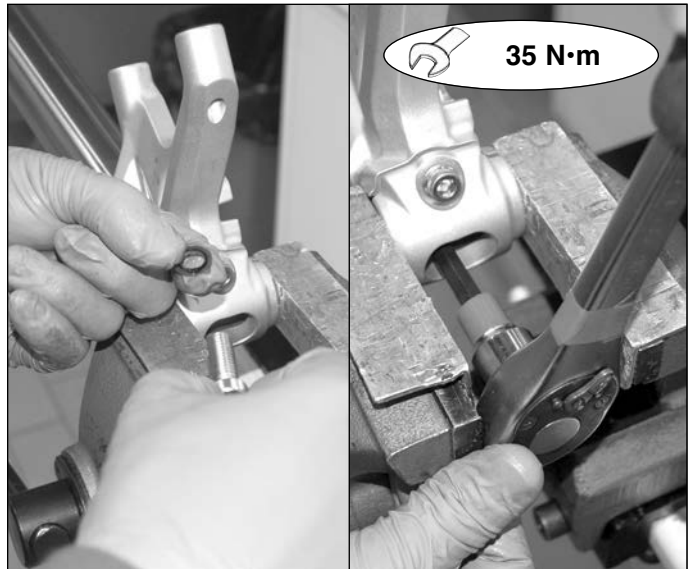

Install the stem with the pump in the sleeve, putting the oil seal in place using the required tool.

 **Special tool No. 8000B6785**





Suspension and wheels

Insert the clamping ring (1) in place.

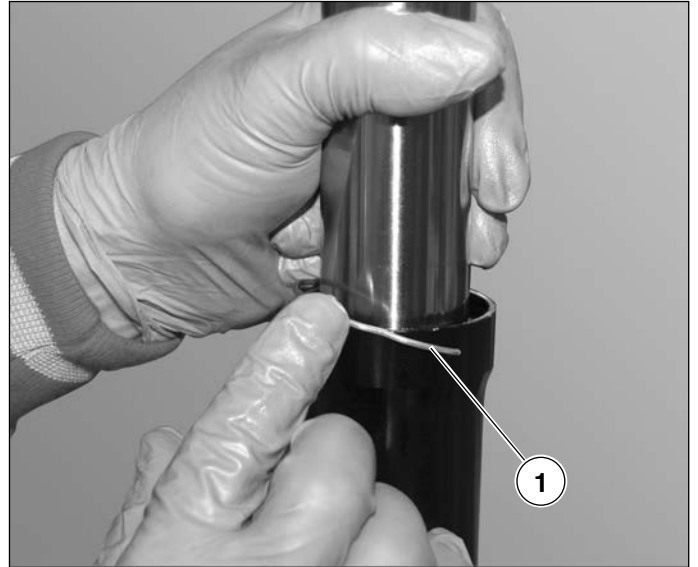

Then, put the dust seal in (2) by hand.



While holding the sheath in an upright position, insert the spring press spacer; pour in the following oil quantities:

- **F3 675:** **460 cc(*)**

(*): *approximate quantity calculated in relation to the actual maintenance level*

Repeatedly move the damping piston rod up and down until the it slides smoothly.



Oil type used: SAE 7,5

Recommended oil: Marzocchi EBH16 SAE 7,5

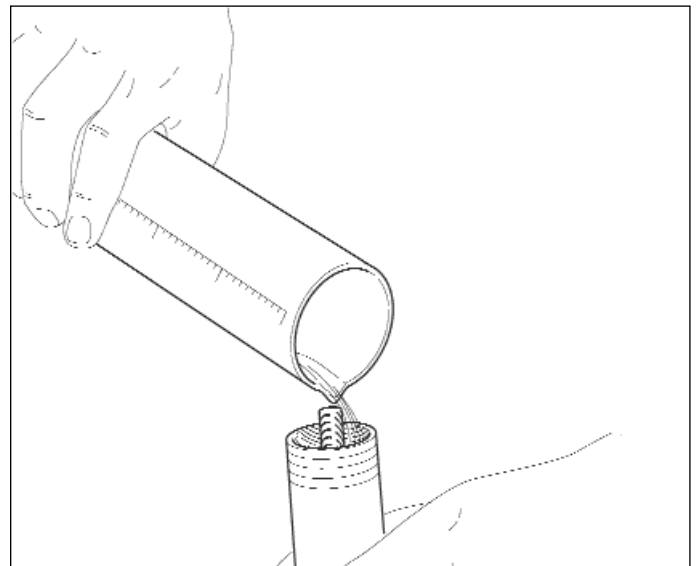

F



Suspension and wheels

Check that the oil is at level "X" with reference to the upper sheath rim, measured when the sheath is completely compressed.

- F3 675 (**): $X = 105 \text{ mm}$

(**): N.B.: Measured with the pumping rod at the end of its stroke and the spring spacer in.

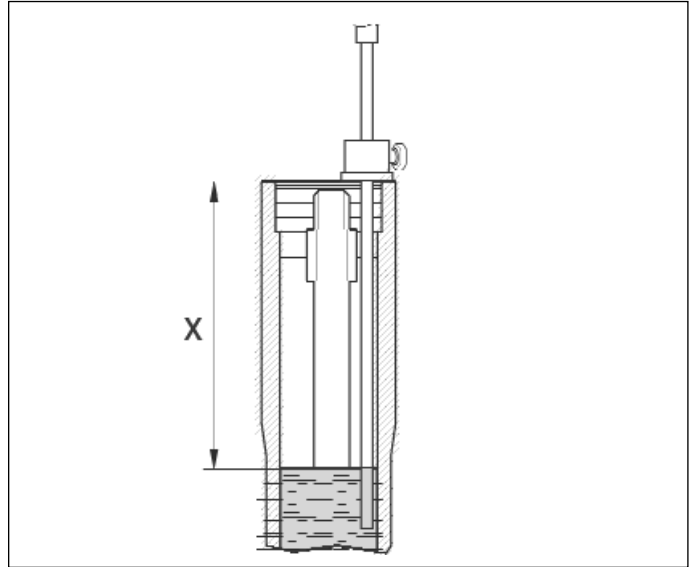

F Lift the plunger and manually turn the conternut (1) in to the end of the threaded portion.

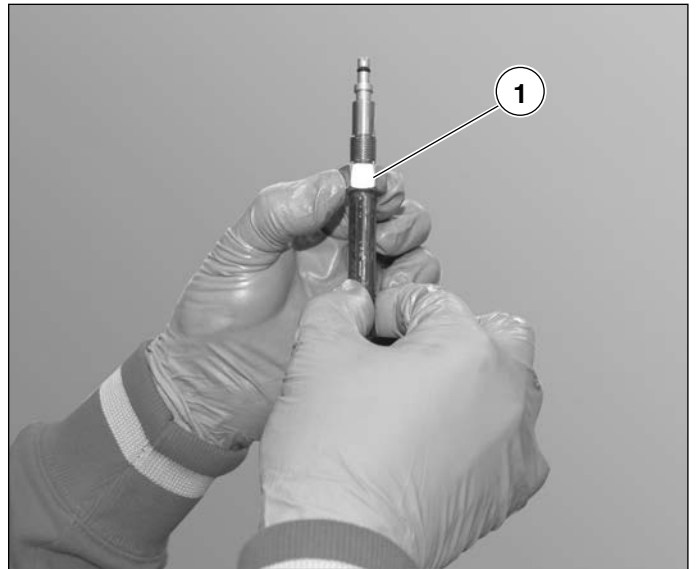

Put the spring in by holding the pump rod in an extended position outside of the sleeve.

Insert the 13 mm wrench under the pump nut (1) to stop the rod from falling out.

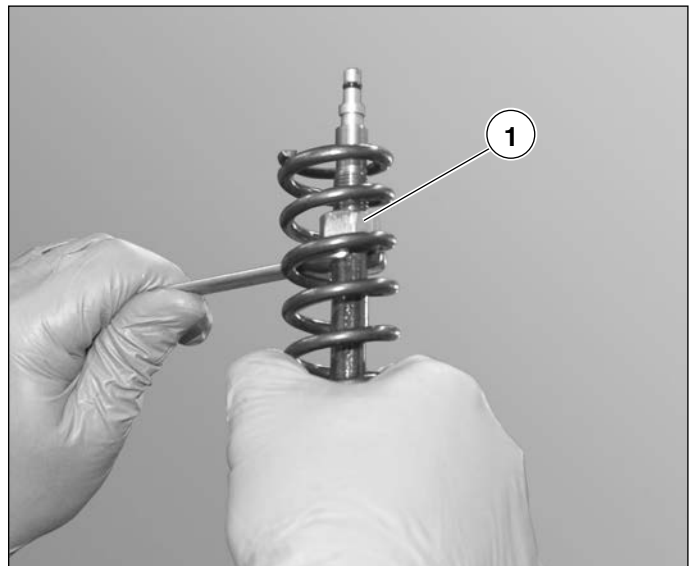

Screw the hydraulic brake adjuster (1) on as far as it will go.

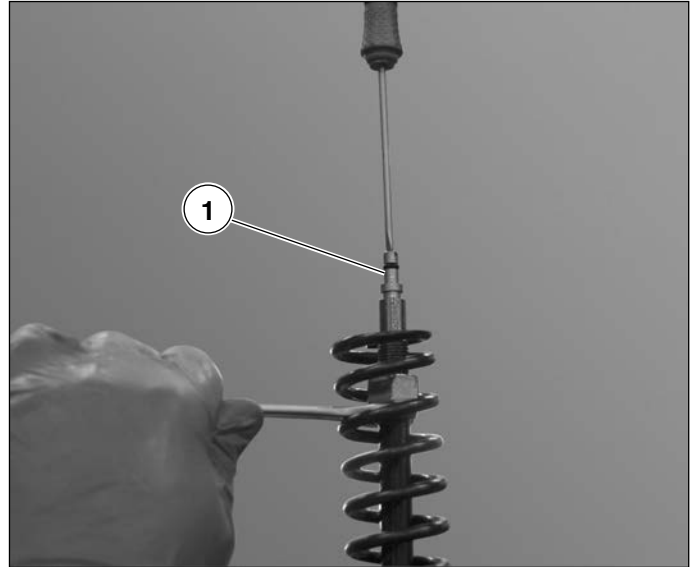

Install the cap (2) complete with new o-ring, by hand, and screw it on until it hits the rod and not the nut.

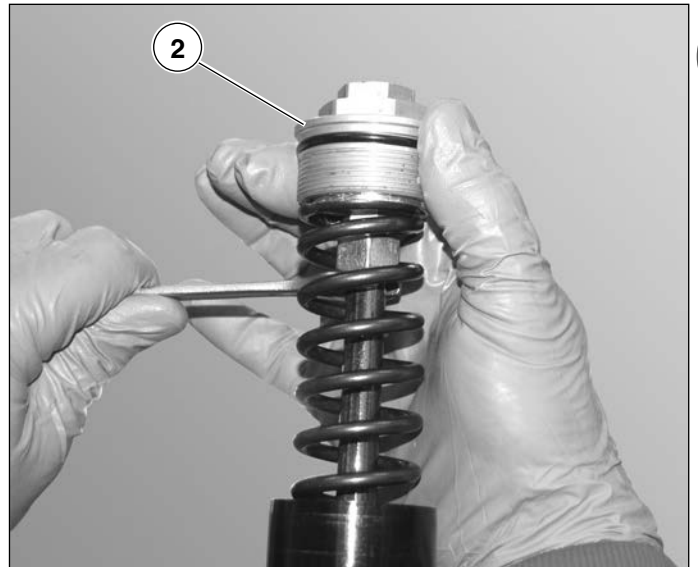

Tighten the plug with the prescribed torque.



Fork leg plug tightening torque: 20 N·m

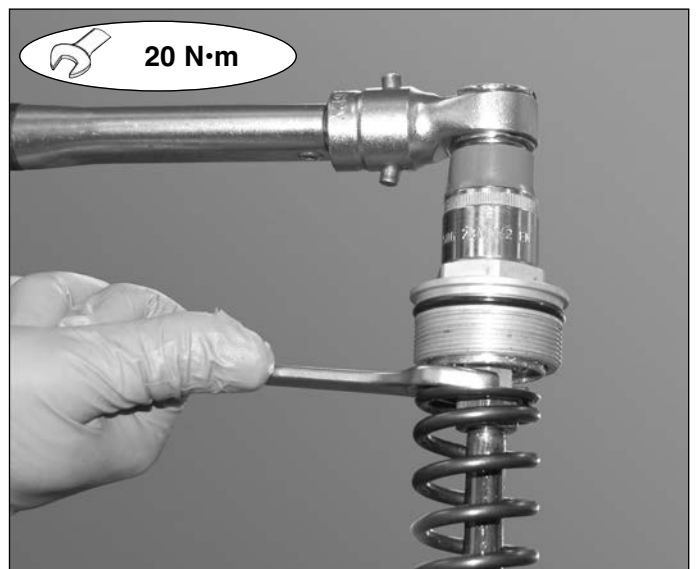



Suspension and wheels

Insert and screw in the complete cap (1) on the fork slider at the required torque.



Sleeve cap torque pressure: 20 N·m

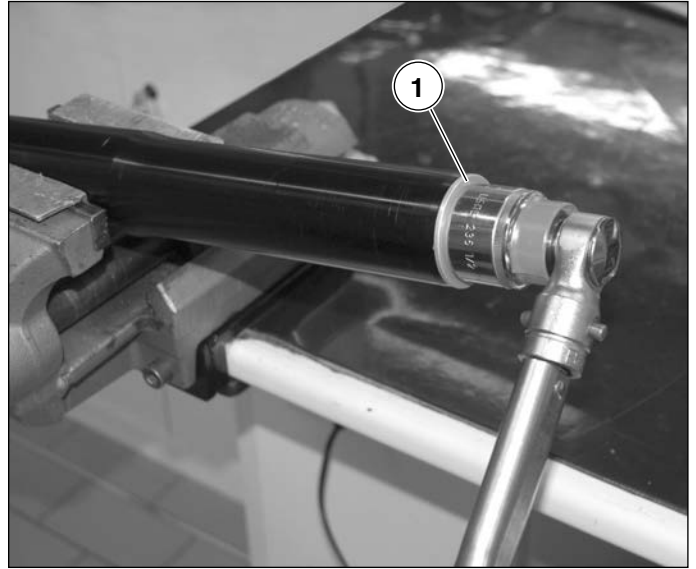

F Fork tube exploding (F3 ORO)

Place the fork leg in a vice, taking care to protect its surface against possible damage.

Release the spring preload by turning the adjustment nut (1) counterclockwise.

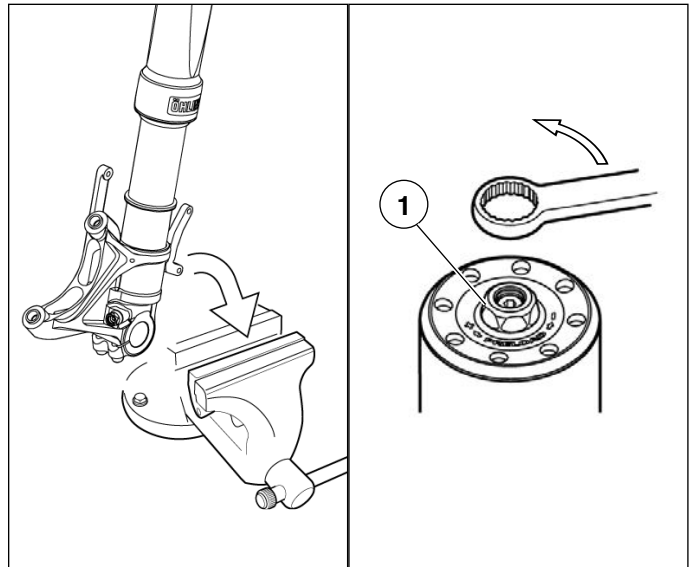

Loosen the top cap assembly (2) by using the special tool.



Special tool No. 8000B6876

Slide the outer fork sleeve all the way down.

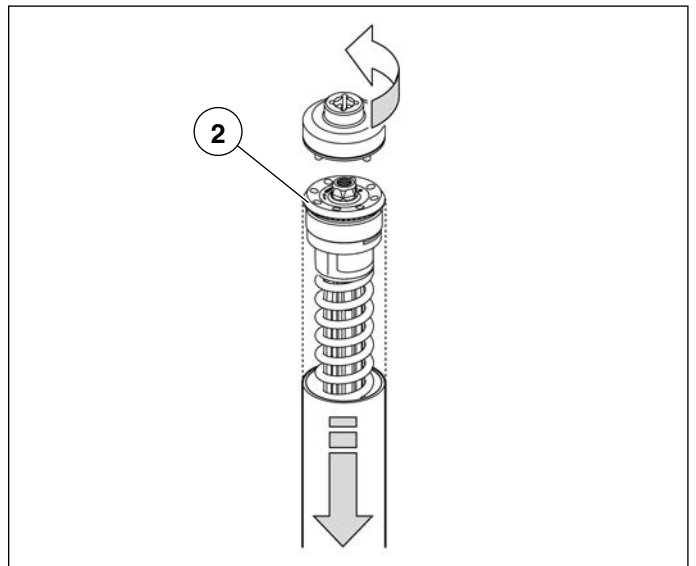

Keep in place the spring support (3) by using the proper spanner (special tool) and remove the top cap assembly by turning it counterclockwise.



Special tool No. 8000B6877

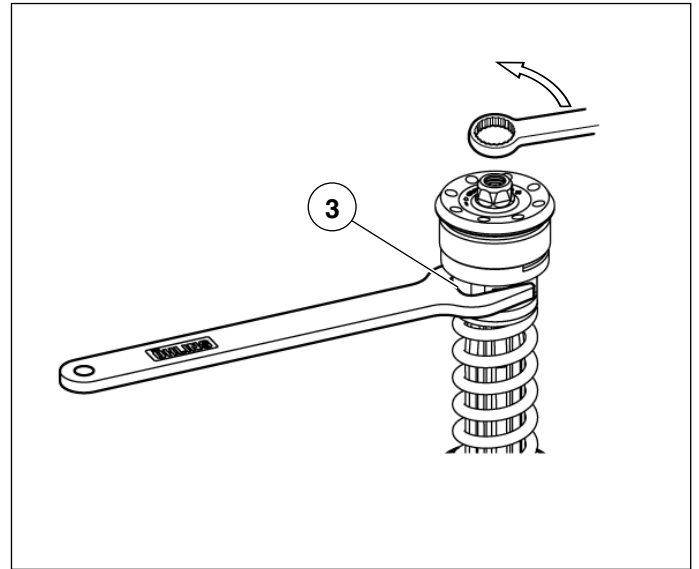

Remove the spanner, the spring support and the spring.

Remove the preload tube by hooking it with a proper wire.

Carefully slide the outer fork sleeve off the inner fork stem.

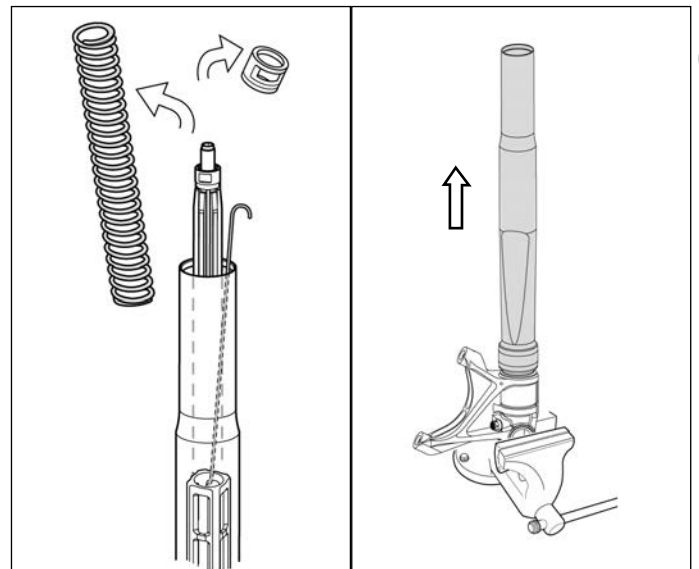

Fork assembly check (F3 ORO)

Check that the sleeve does not have marks on the external part that could have repercussions inside the assembly. Ensure that the inside is completely smooth, without any scratches. If necessary, substitute with a new part.

For the replacement of the inner components of the fork, perform the following operations.

Put the outer fork sleeve upright on a bench with the seal side up. Remove the scraper, the circlip, the oil seal and the support washer.



Protect the edge of the outer fork sleeve with a rag when disassembling the oil seal. Use a flat tire lever to remove the seal as shown in the picture.

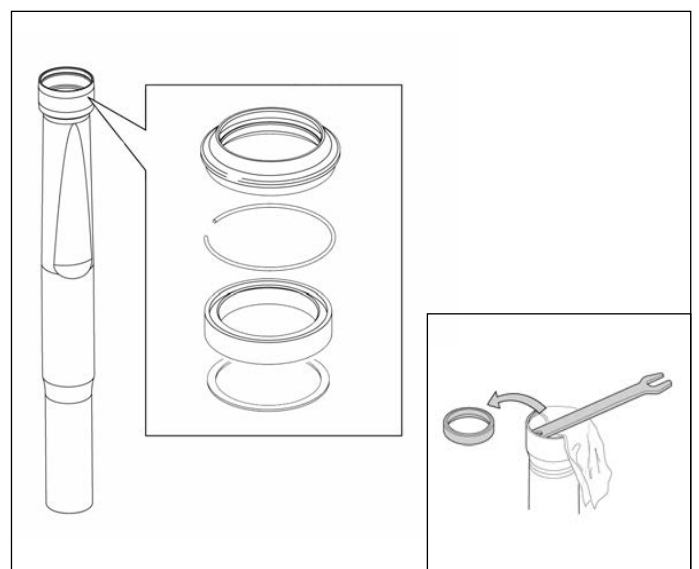

F



Suspension and wheels

For the replacement of the outer fork sleeve bushings, use the special tool.



Special tool No. 8000B6871

NOTE The above tool is made with different parts (see scheme). These parts must be alternatively assembled together according to the operation to be performed, as shown in the following steps.

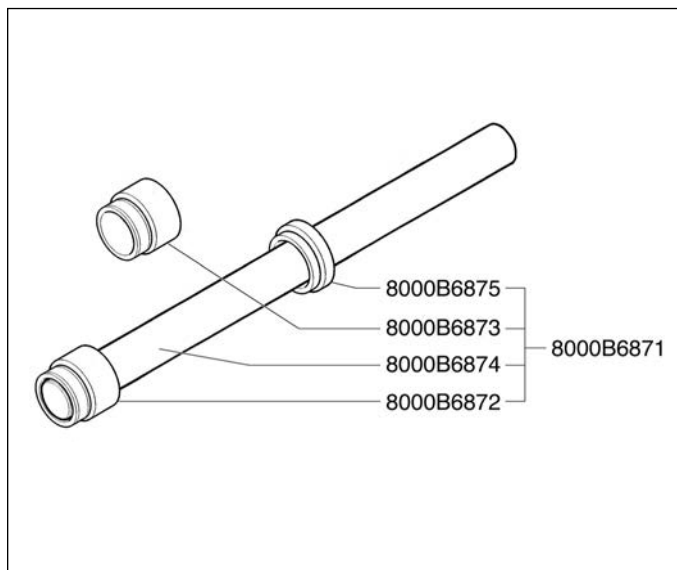

F Use a heat gun to heat the outer fork sleeve in the areas shown in the picture to approximately 100°C.

In order to remove the bushings from the outer fork sleeve, it is necessary to modify the special tool no. 8000B6871 by assembling the following elements:



- Bar No. 8000B6874
- Guide ring No. 8000B6875
- Bushings disassembling tool No. 8000B6873

Put the outer fork sleeve on a soft surface with the seal side facing up, then remove the bushings by inserting the previously assembled tool and tapping it gently with a plastic hammer.

After having carefully checked all components, substitute those damaged and/or deteriorated.

Install the bushings while the outer fork sleeve is still warm. Put the outer fork sleeve on a soft surface with the seal side facing up.

In order to reassemble the bushings on the outer fork sleeve, it is necessary to modify the special tool no. 8000B6871 by assembling the following elements:



- Bar No. 8000B6874
- Guide ring No. 8000B6875
- Bushings installation tool No. 8000B6872

Apply thread-locking fluid of the prescribed type on the outer surface of the upper bushing.



Threadlocking product used: Loctite 648

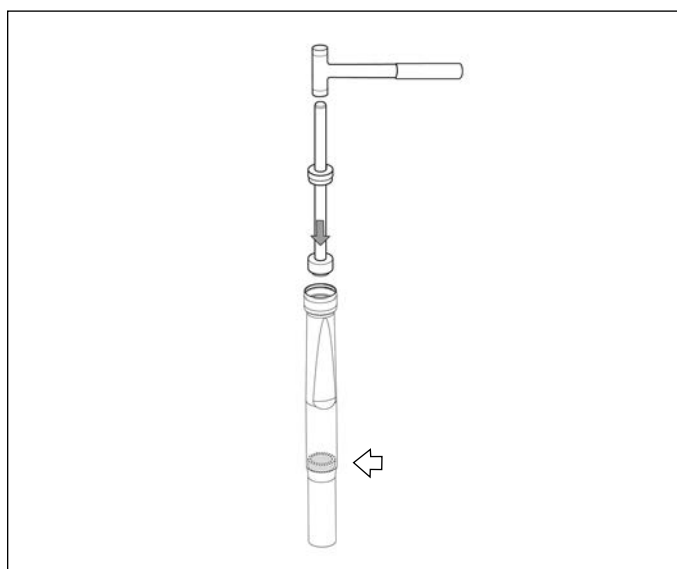
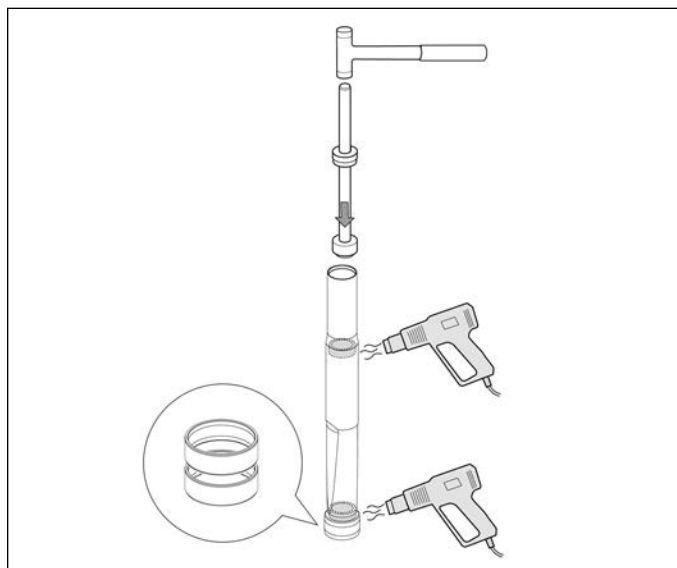



Suspension and wheels

Install the upper bushing into the outer fork sleeve by using the previously assembled tool and tapping it gently with a plastic hammer, until it reaches a solid stop.

Apply the prescribed grease on the outer surface of the lower bushing.



Recommended grease: Ohlins Red Grease (cod. 00146-01)

Install the lower bushing into the outer fork sleeve by using the previously assembled tool and tapping it gently with a plastic hammer, until it reaches a solid stop.

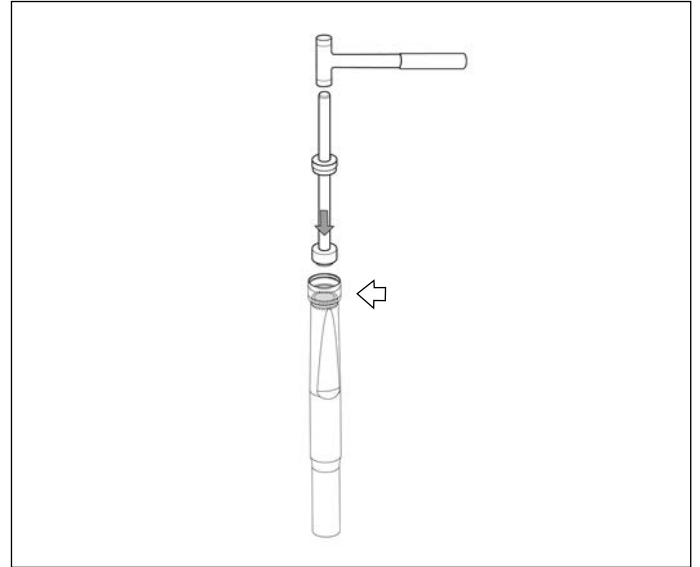

Apply a thin layer of the prescribed grease on the outer surface of the washer and of the oil seal. Install them into the outer fork sleeve.



Recommended grease: Ohlins Red Grease (cod. 00146-01)

Install the circlip behind the oil seal.

Apply the prescribed grease to the scraper seat and carefully press fit the scraper on the outer fork sleeve.



Recommended grease: Ohlins Red Grease (cod. 00146-01)

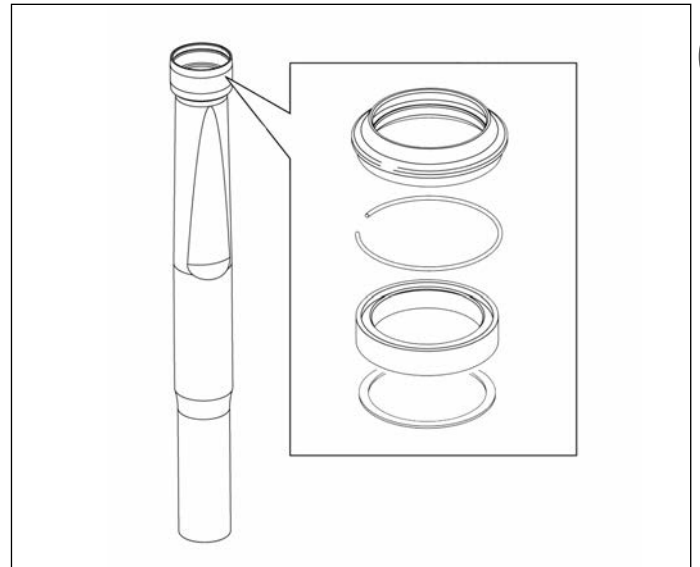

Fork oil substitution (F3 ORO)

Turn the stem upside down and completely pour out the oil into a suitable container.



Recover the oil in an appropriate container. Do not dispose of the used oil in the environment.

Place the fork leg in a vice, taking care to protect its surface against possible damage.

Apply some front fork oil on the inner surface of the fork sleeve. Insert the fork sleeve on the fork stem and carefully slide it all the way down.

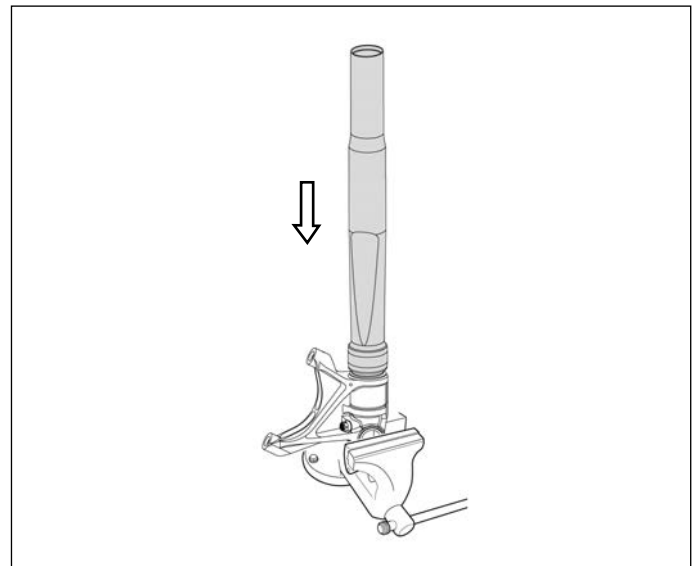

F



Suspension and wheels

While holding the fork leg in an upright position, pour in the following oil quantities:

- **F3 ORO:** **420 cc (*)**

(*): *approximate quantity calculated in relation to the actual maintenance level*

Repeatedly move the fork sleeve up and down until it slides smoothly.



Oil type used: SAE 5W

Recommended oil: Ohlins Suspension fluid 01309-01 SAE 5W 19,0 Cst



Use Ohlins front fork oil only.

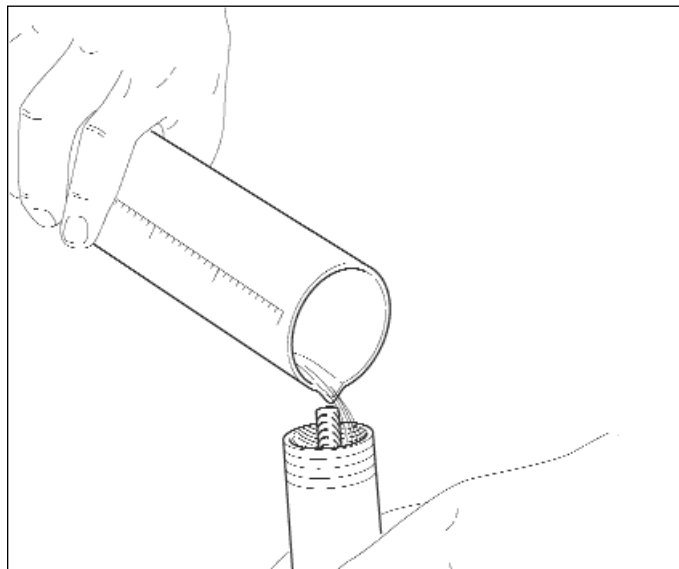

F Check that the oil is at level "X" with reference to the upper fork leg rim, measured when the fork is completely compressed.

- **F3 ORO (**):** **X = 140 mm**

(**): **N.B.:** Measured with the pumping rod at the end of its stroke.

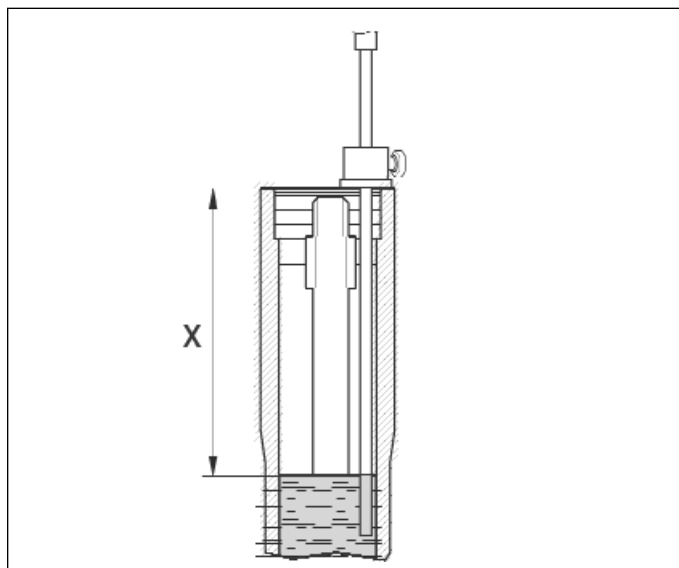

Install the preload tube, the spring (with the marking facing up) and the spring support.

Screw the pull-up tool (special tool) on the pumping rod and pull it upwards. Push downwards the pull-up tool collar to contract the spring. Place the proper spanner in the spring support in order to keep the spring compressed.



Special tools:

- **Pull-up tool No. 8000B6878**

- **Spanner No. 8000B6877**

Remove the pull-up tool.

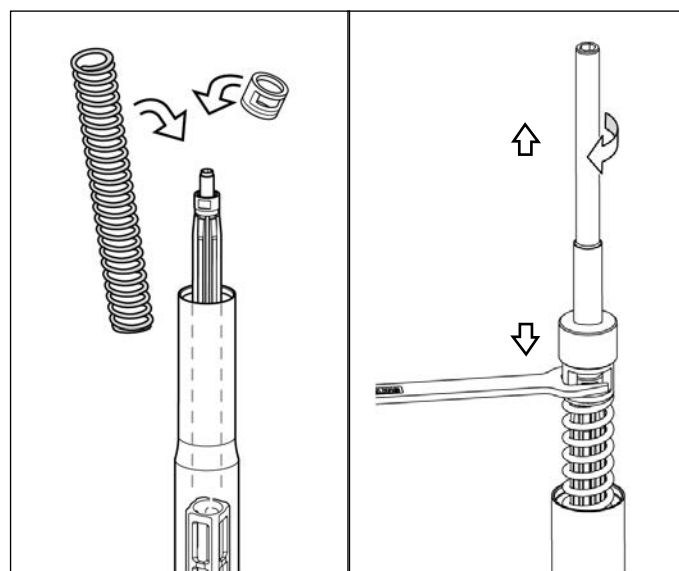



Suspension and wheels

Screw the top cap assembly on the pumping rod until it comes to a stop.

Keep in place the spring support (1) by using the proper spanner (special tool) and tighten the lock nut to the prescribed torque.



Torque pressure: 20 N·m

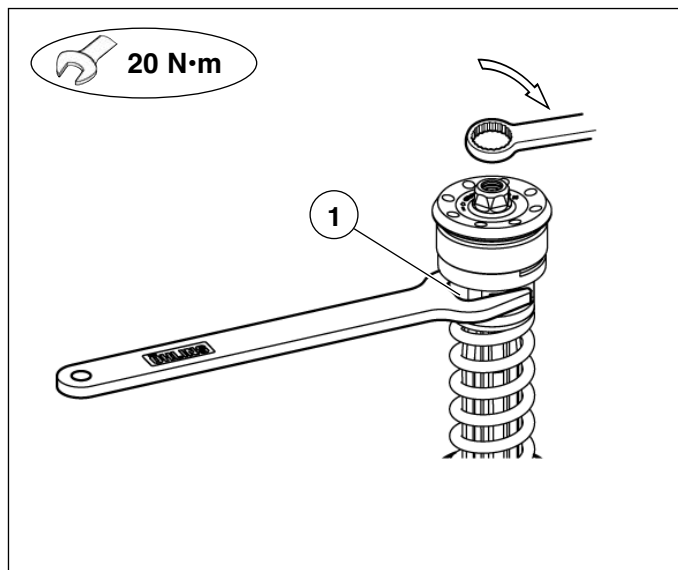

Apply prescribed grease on the top cap O-Ring and threads.



Recommended grease: Ohlins Red Grease (cod. 00146-01)

Fully extend the fork leg.

By using the special tool, screw the top cap into the outer fork sleeve with the prescribed tightening torque.



Special tool No. 8000B6876



Torque pressure: 10 N·m

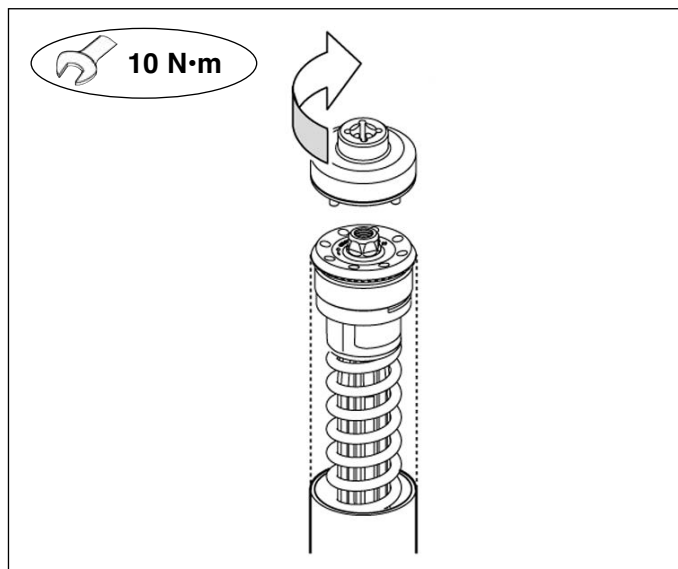

Fitting the fork legs

Reassemble the stem taking care to pass the electrical wiring, the clutch tube and the brake pipe as shown in the picture.

To ensure proper positioning of the rods, refer to the figure at right, taking care to observe fitting dimension "X":

- F3 675:

X = 216 mm

- F3 ORO:

X = 216 mm

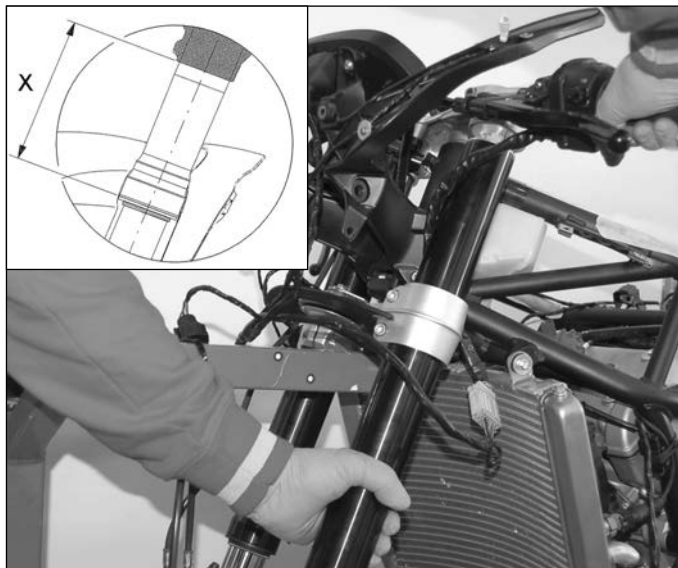



Suspension and wheels

Screw in and tighten the two screws (1) at the base of the steering.

 **Carry out this assembly correctly. A casual or inexact assembly could compromise the stability and steering of the motorcycle.**

Fit the right-hand leg following a similar procedure.

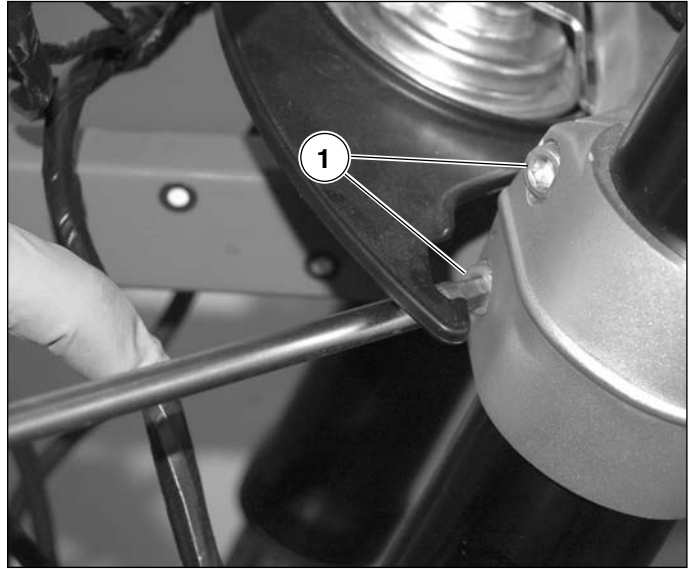

F Tighten the two screws (1) at the base of the steering. **Effectuate the operation several times until the torque wrench does not turn the screw any more.** This operation must be carried for both stems.



Grease only the first threads.



Torque pressure: 18 N·m

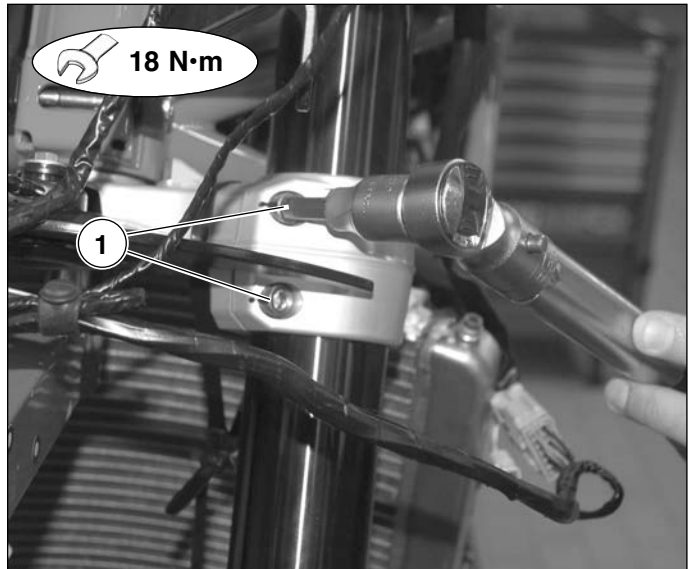

Assembly clip-on handlebars

Position the electrical wiring as shown in the figure.





Suspension and wheels

Install the clip-on being careful of fitting the pin of the clip-on into place when the steering head is re-installed.



Tighten the screws (1) to the prescribed torque pressure.



Grease only the first threads.



Torque pressure: 8 ÷ 10 N·m



Re-install the steering head making sure that it fits perfectly in place.

Tighten the two screws (2) of the steering head/stems to the prescribed torque pressure



**Torque pressure steering head (2):
16 ÷ 18 N·m**



Grease only the first threads.



This check is necessary for the correct positioning of the stems even if the steering head has not been removed. This check guarantees the standard set-up of the motorcycle.

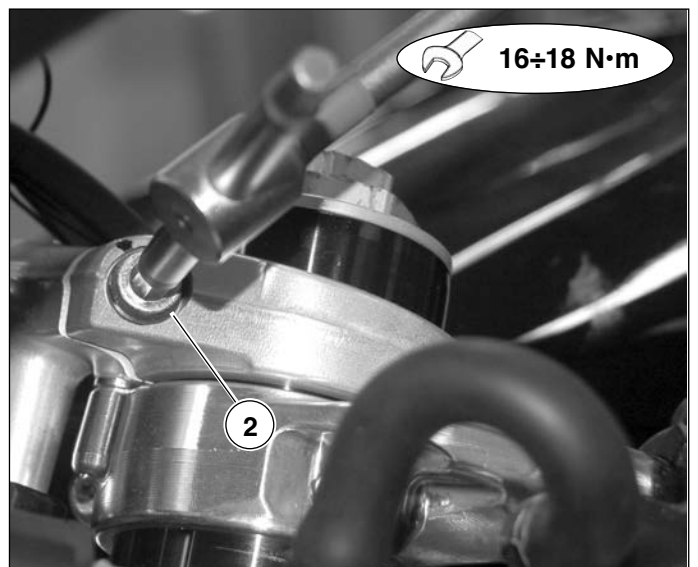



Suspension and wheels

Re-assemble the retaining clamp (1) for the front brake pipe (2) on the right stem.

Mount the front wheel and brake callipers according to procedures contained in the previous pages.

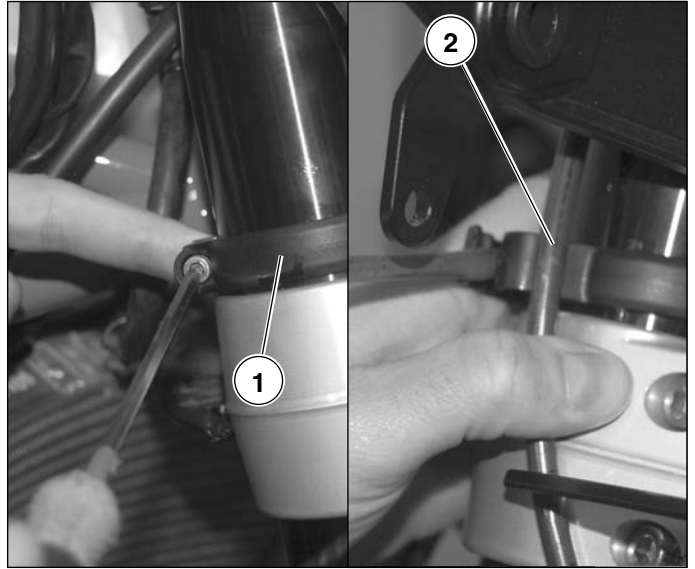

Front suspension adjustment

After properly fitting the fork assembly, adjust the front suspension so as to ensure optimum vehicle geometry.

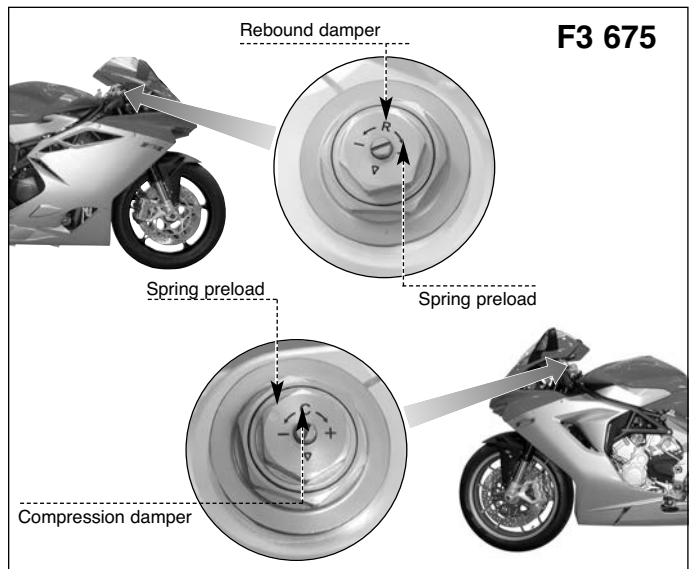

Refer to values contained in the table to adjust front suspension at the bottom of the next page.

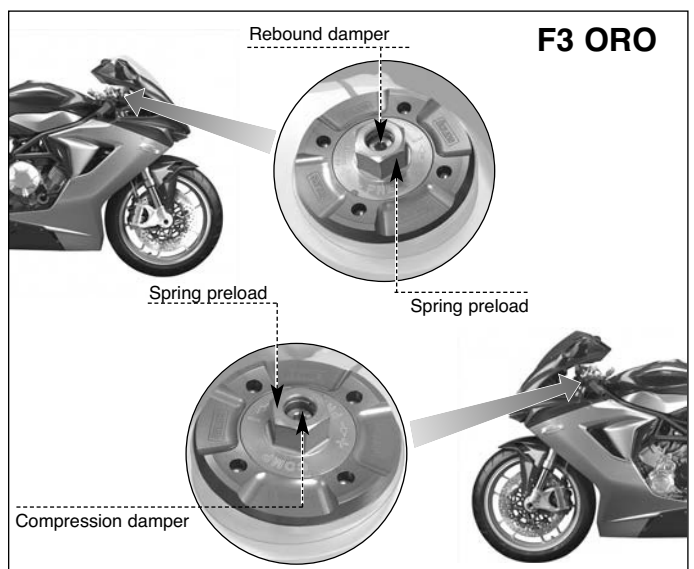



Suspension and wheels

NOTE Adjustments contained in the table must be carried out from initial reference positions:

- Spring preload: Turn counter-clockwise to end stroke.

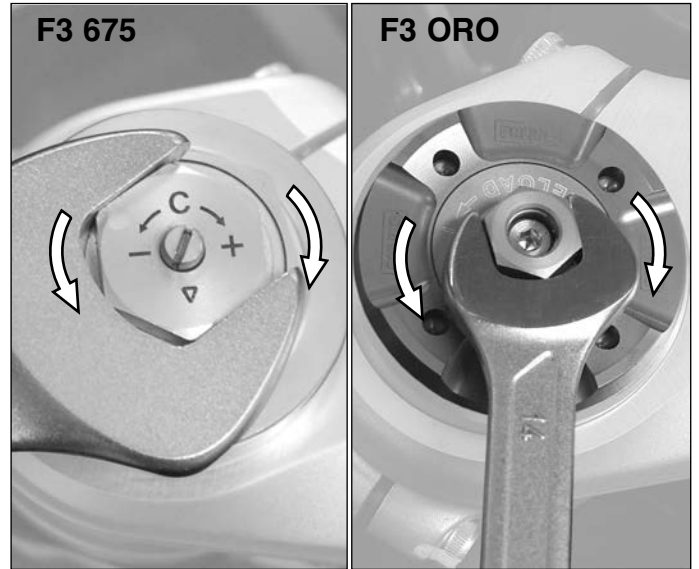

- Extended brake: Turn clockwise to end stroke.

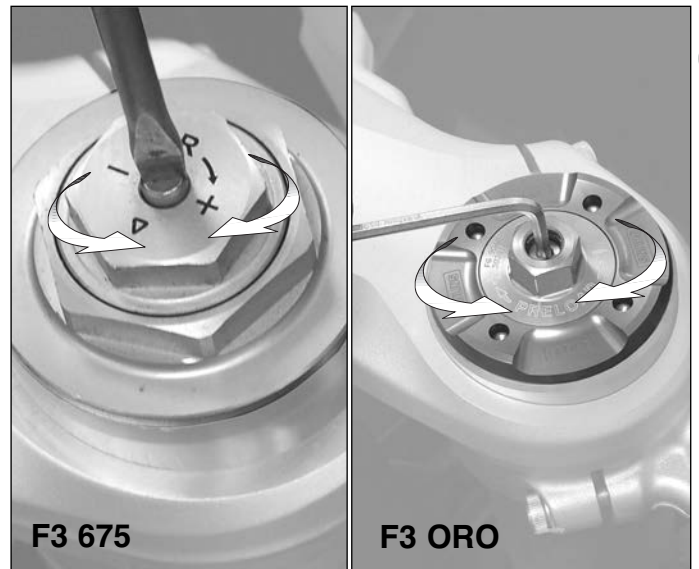

- Compressed brake: Turn clockwise to end stroke.

	Type of set-up		
	F3 675		F3 ORO
	On road	On race track	
Spring preload	5 turns	7 turns	6 turns
Rebound damping	1,25 turns	2 turns	20 clicks
Compression damping	1 turns	0,5 turns	20 clicks

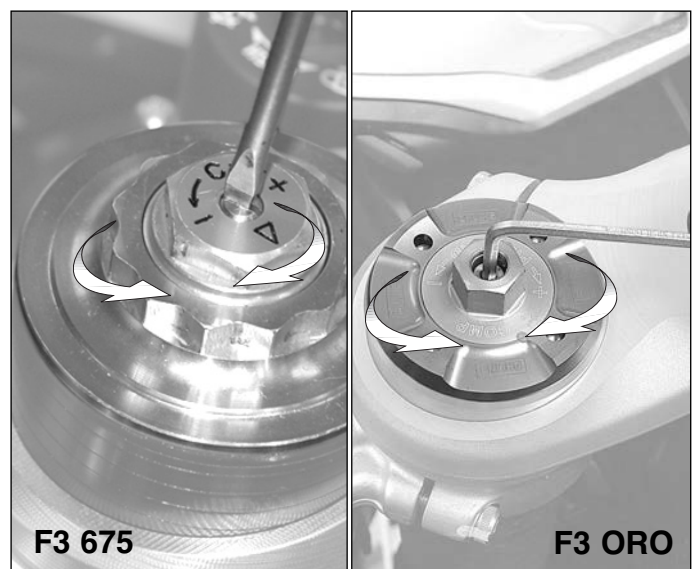

F



Suspension and wheels

STEERING ASSEMBLY

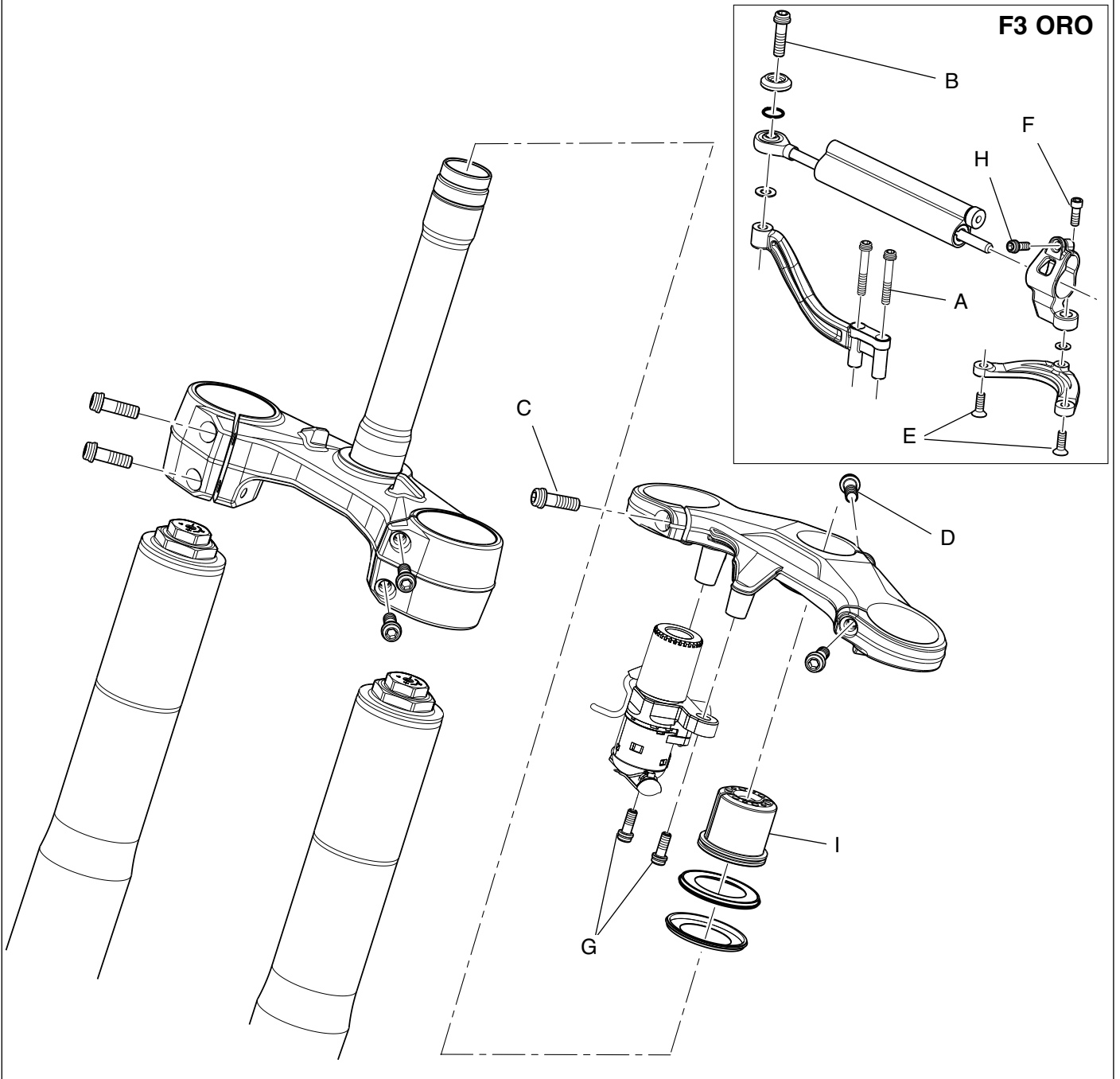

		A	B	C	D	E	F	G	H	I
Torque pressure	N·m	8	25	16 ÷ 18	22 ÷ 24	8	8	10	4	Into contact +10°
	Kg·m									
	ft·lb									
Operation		2400	2400			2700	2700	243		



Suspension and wheels

STEERING ASSEMBLY OVERHAUL

Lift the motorcycle and rest it on the special tool.



Special tool No. 8000B6789



Disassembly of the steering damper (F3 ORO)

Remove the screw (1) that clamps the steering damper to the frame.



F

Steering head removal

Loosen the three fixing screws (2) of the steering head.

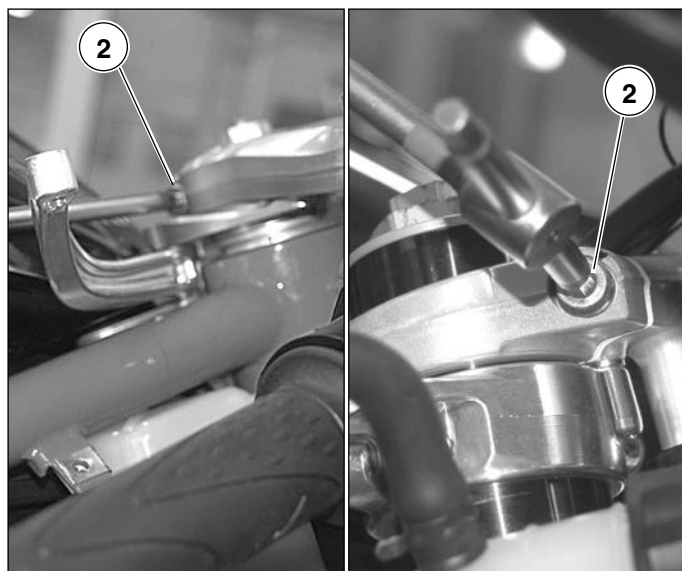



Suspension and wheels

Remove the 3 clamps from the ignition switch cable.

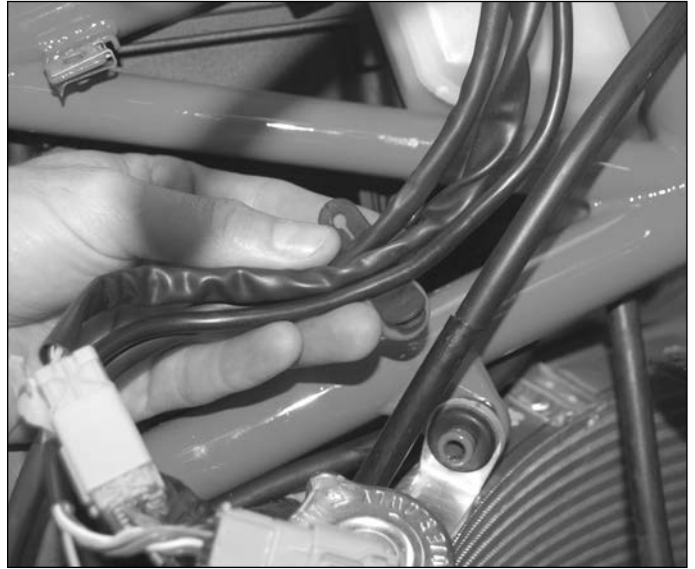

F Then remove the steering head complete with shock absorber and ignition key switch. If necessary, use a rubber mallet to slide the steering head out.



Remove the steering head by disconnecting the key switch connector.



Steering base removal

Preliminary operations:

- Disconnect the connectors (1) of the acoustic warning signal.



- Disconnect the electric connectors leaving the clips assembled on the forks.

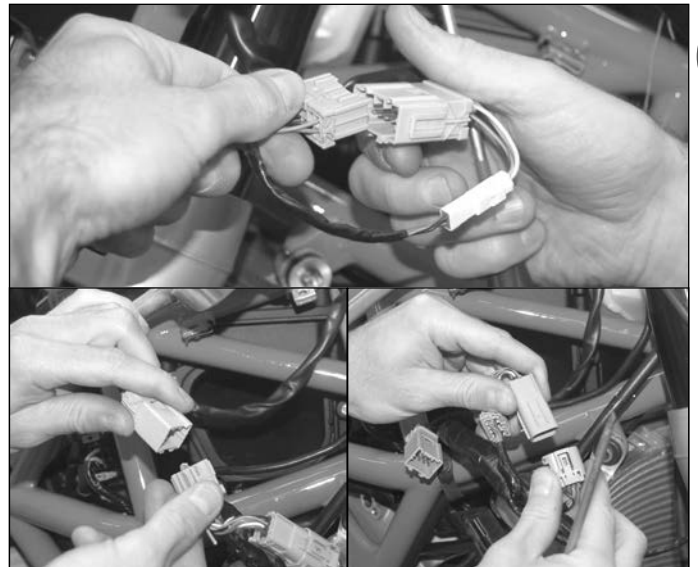

- Then free up the clutch cable (1), the electric cables for the flashing indicator lights (2) and disconnect the connector (3) from the dashboard.

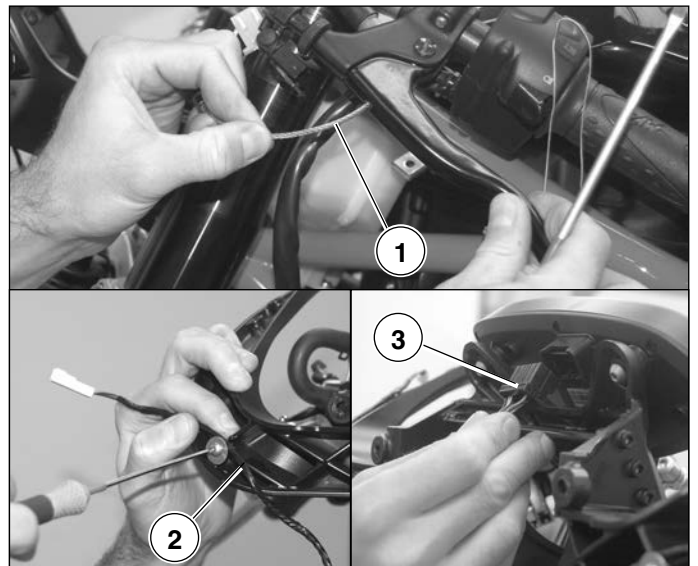



Suspension and wheels

Using the specific tool, loosen the ring nut of the steering spindle, supporting the base of the steering head.

 **Special tool No. 800091645**



F Remove the ring nut that was loosened previously and remove the steering base complete with pin using the relative front stand.

 **Special tool No. 800095807 and 8000B7340**

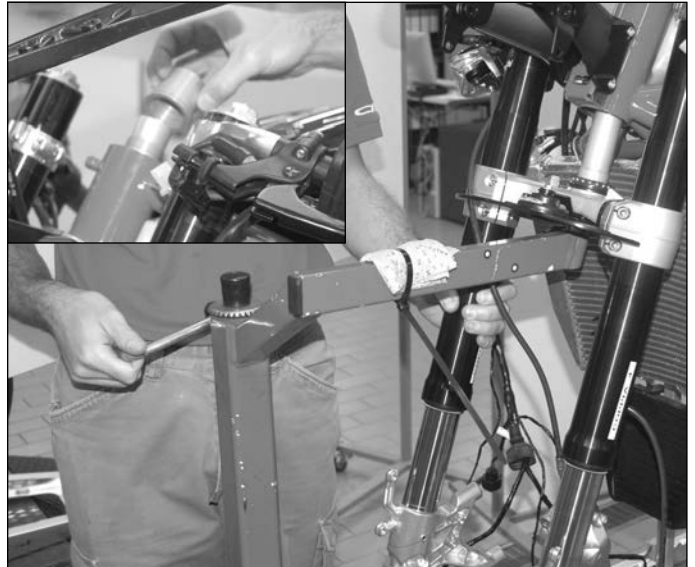

NOTE Support the connecting pipe for the front brake calipers with a clamp (1) anchored to the steering base.

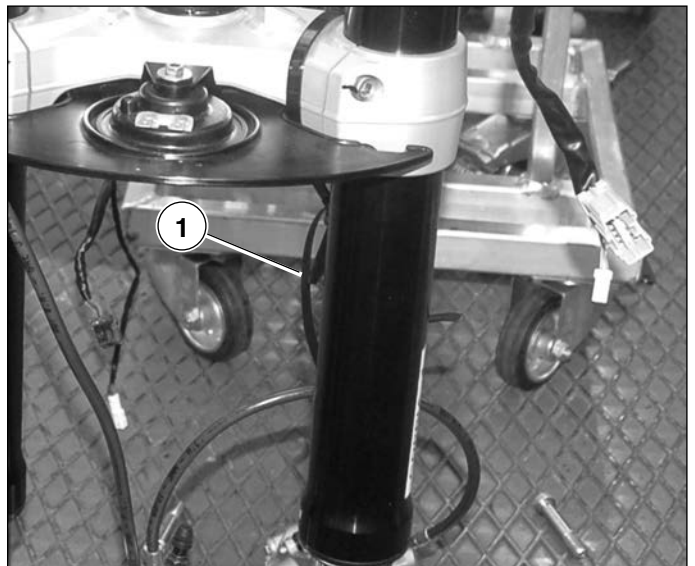



Suspension and wheels

Steering base assembly

Accurately clean all the parts and check the general condition.

Before reassembly, grease the ball bearing ring and place it onto the steering pin.



Recommended grease Agip Grease 30



Fit the lower triple clamp to the frame.

Fit the upper ball bearing race after greasing it.

Fit the bearing inner race, the dust seal and the upper clamping collar.



F

Steering pin tightening

Screw down, without tightening, the screw ring of the steering pin.

This operation must be done manually.

Ensure that the steering base is turned as far as possible to the right.

Utilising the special tool, tighten the screw ring (1) by rotating it 10°



Special tool No. 800091645

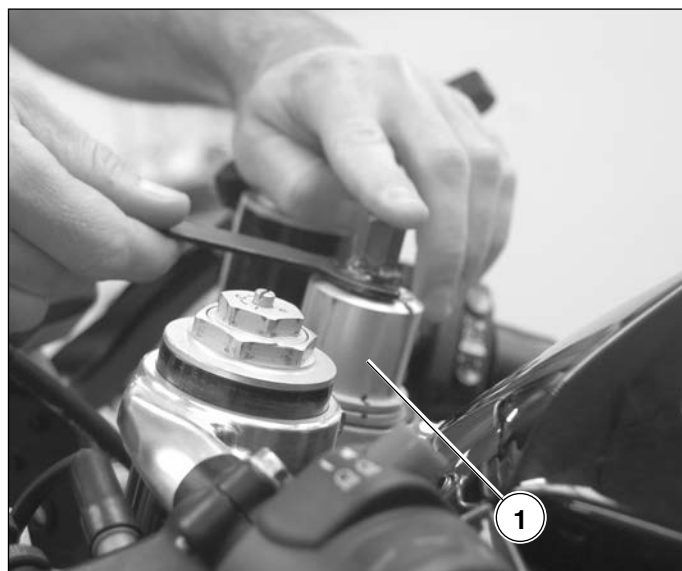



Suspension and wheels

Disassembly of Ignition key switch

To disassemble and replace the ignition key switch, it is best to completely remove the motorcycle steering head.

Remove the three ignition switch connector clamps (1).

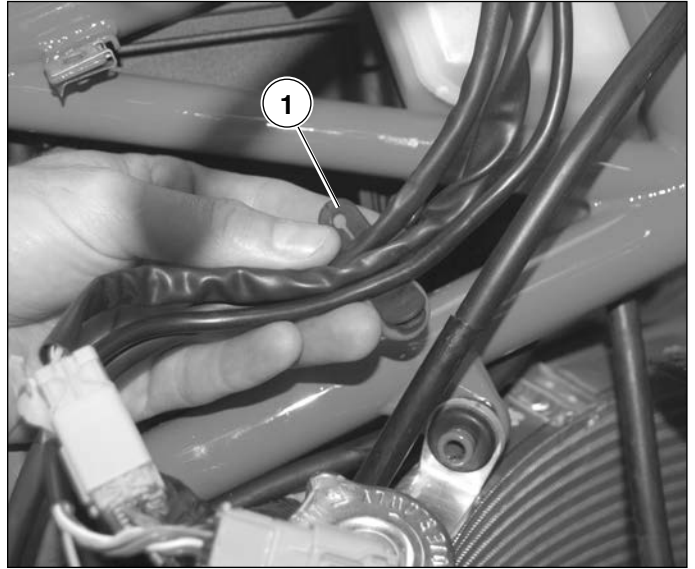

Disconnect the ignition switch connector (2).

F

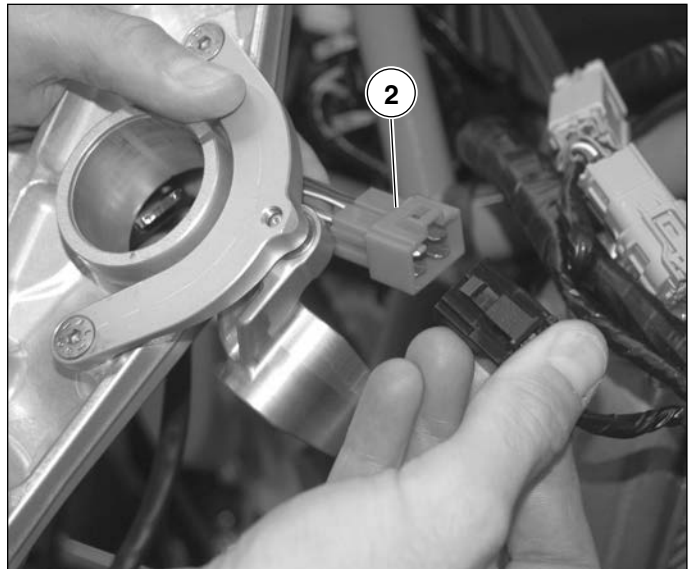

Remove the complete steering head from the motorcycle as described in the "Steering head disassembly" paragraph.

For the ORO version, disconnect the steering damper from the frame as described in the "Steering damper disassembly" paragraph.





Suspension and wheels

Remove the 2 key switch fixing screws and extract them.

 **When reassembling, apply the following tightening torque: 10 N·m**

 **Threadlocking product used : Loctite 243**



Disassembly of the steering damper clamp (F3 ORO)

Loosen the clamp (1) and slide off the damper (2).

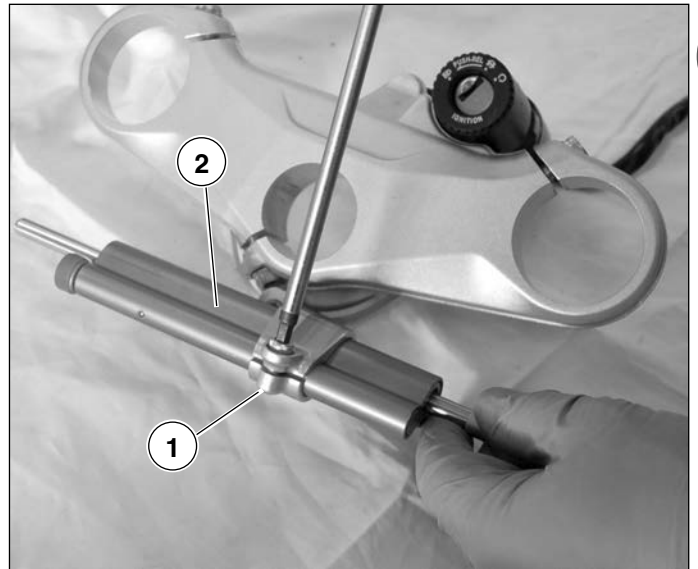

Heat the screw (3) for the clamp using a heat gun, and then unscrew it. The heating procedure is necessary because the ball is locked on with Loctite. Be careful to recover the shim located under the ball joint.

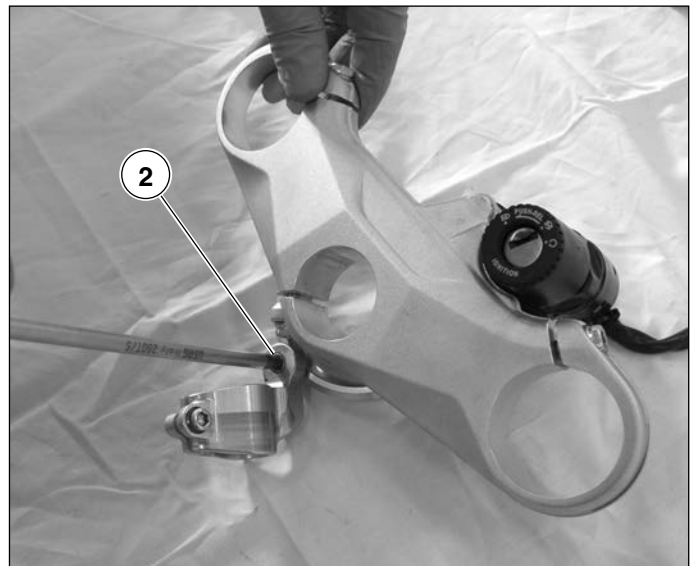

F



Suspension and wheels

Remove the anchoring from the steering head by unscrewing the two screws (4) after they have been heated, as described above.

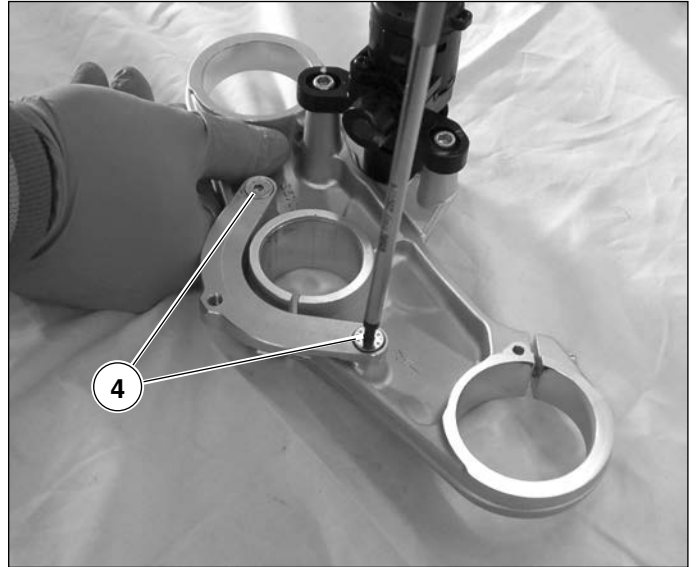

Clamp assembly

F During re-assembly apply Loctite 2700 to the two screws (1) that clamp the anchoring to the head. Tighten the screws to the prescribed torque pressure. Assemble the counter-nut to the prescribed torque pressure.



Threadlocking product used: Loctite 2700



Torque pressure: 8 N·m

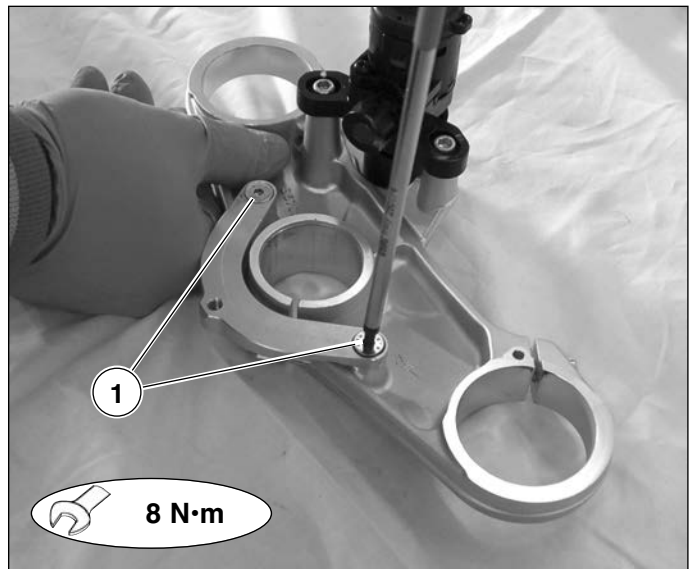

Use Loctite strong threadlocker 2700 on the screw (2) that secures the clamp to the anchoring. Tighten the screw to the prescribed torque pressure.



Threadlocking product used: Loctite 2700



Torque pressure: 8 N·m

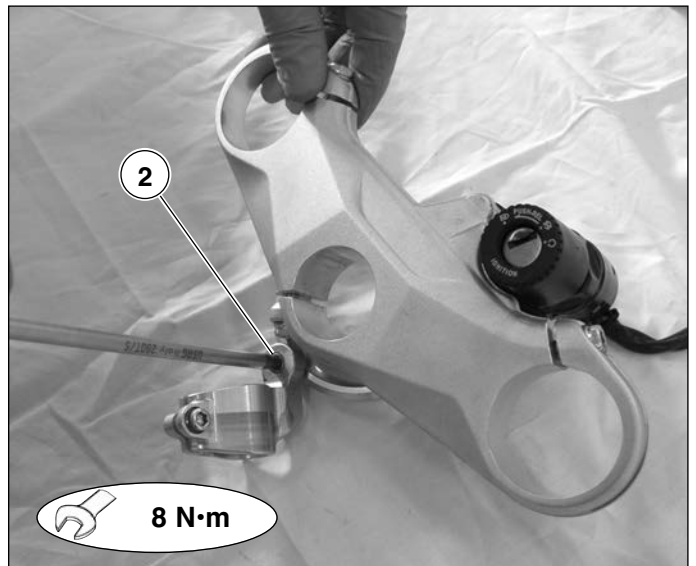



Suspension and wheels

Slide the damper into the clamp observing the direction of assembly and place it at the required distance of 35 mm.

Tighten the screw to the prescribed torque pressure.



Torque pressure: 4 N·m

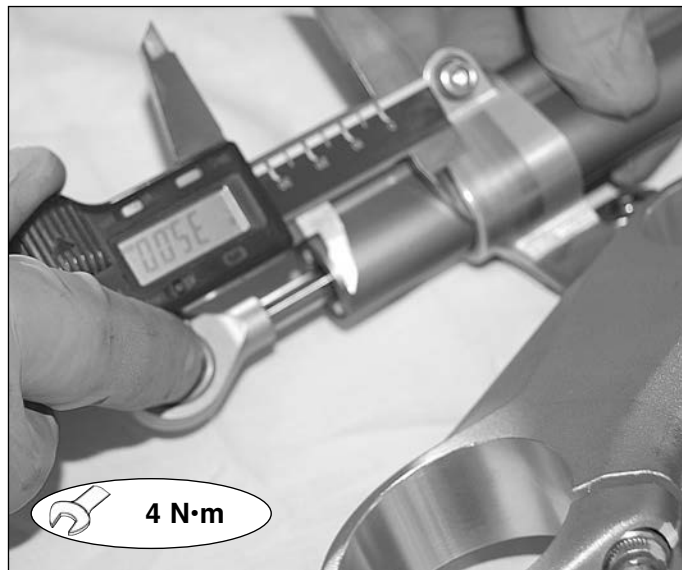

Steering head assembly

Position the steering head in its housing according to the inverse order of disassembly operations.



Tighten the central fixing screw (1) of the steering head.



Torque pressure: 22 ÷ 24 N·m

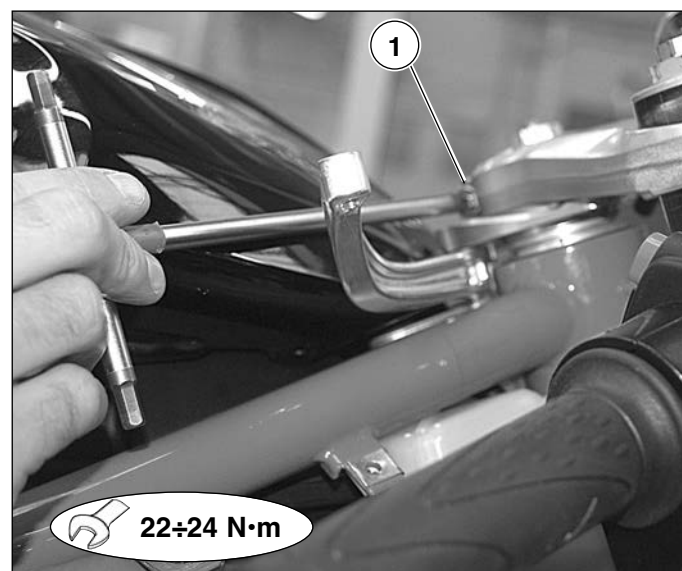



Suspension and wheels

Tighten the two front fixing screws (2) of the steering head.

 **Torque pressure: 16 ÷ 18 N·m**

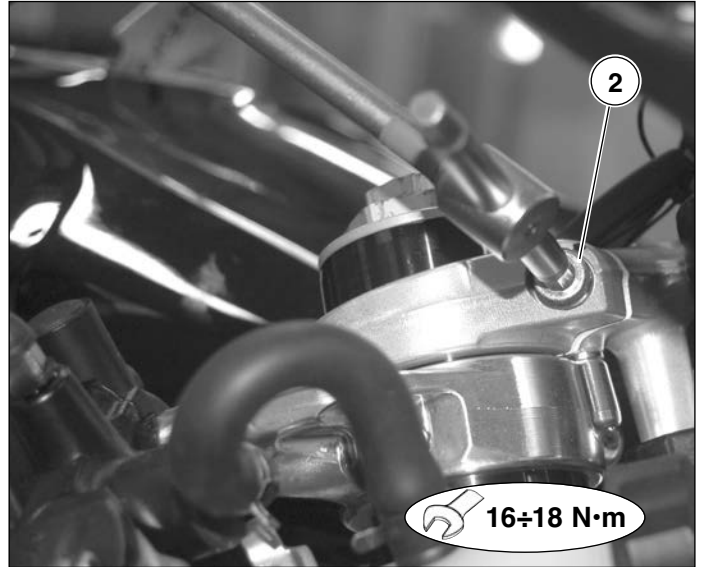

F Block the steering shock absorber in position by tightening the fixing screw to the frame.

 **Threadlocking product used: Loctite 2400**

 **Torque pressure: 25 N·m**

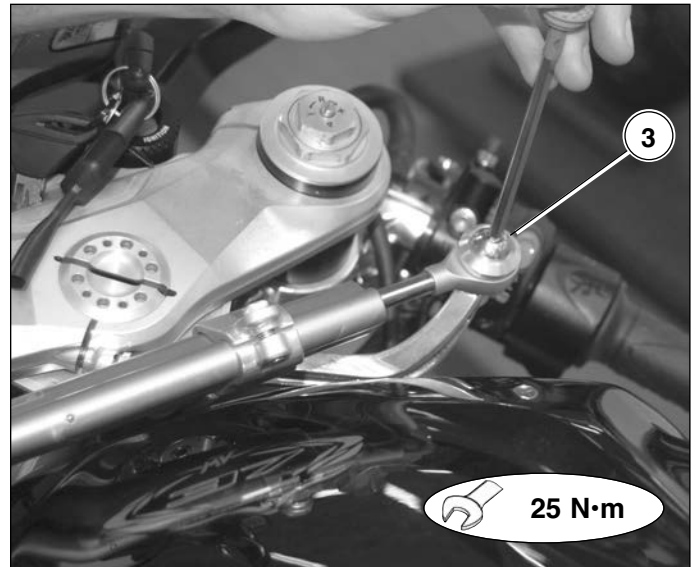

REAR SUSPENSION AND SWINGARM

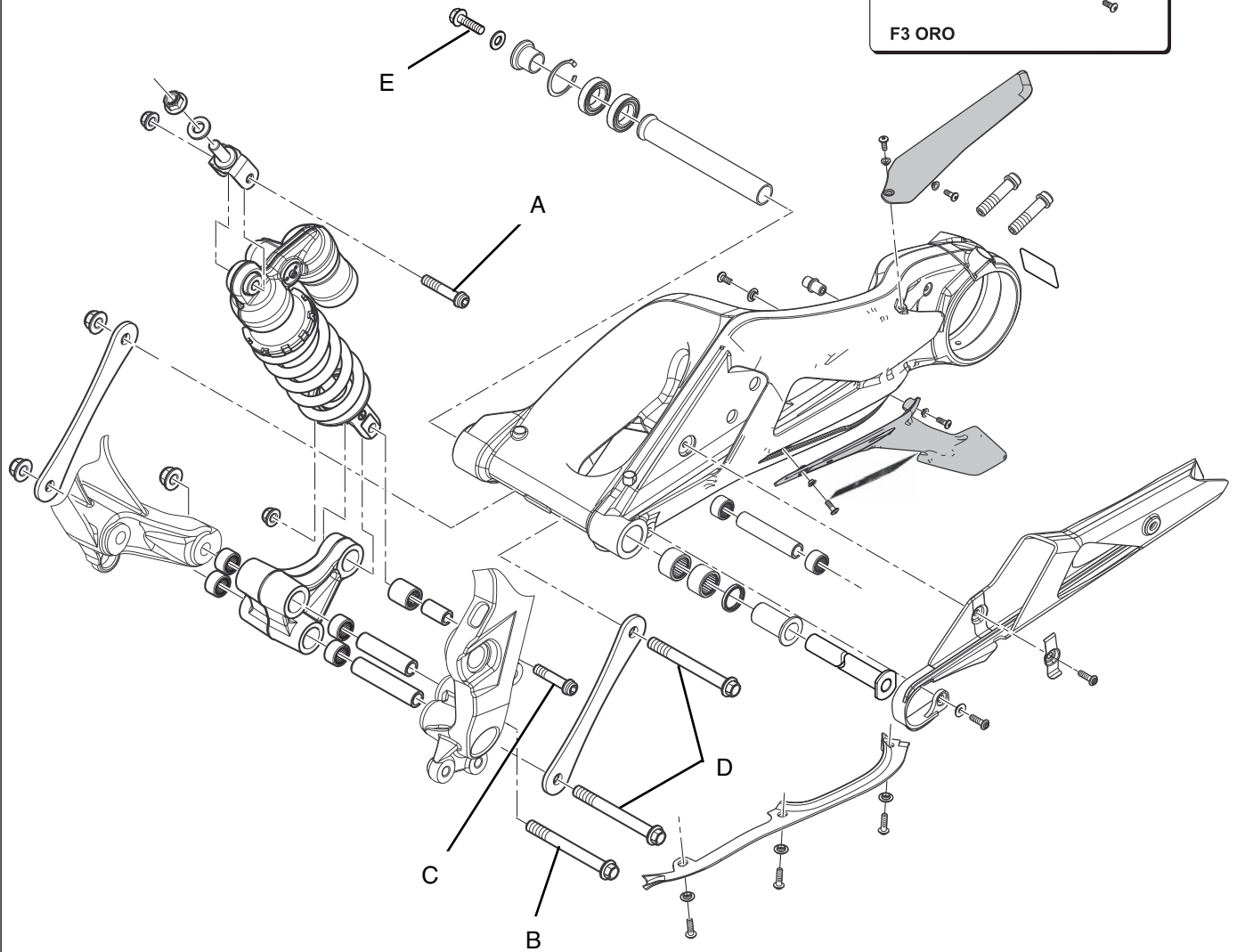
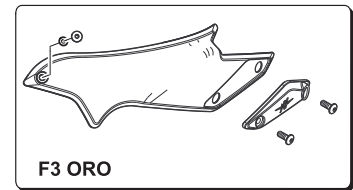

F

	A	B	C	D	E				
Torque pressure	N·m	40 ÷ 44	55 ÷ 60	40 ÷ 44	55 ÷ 60	70 ÷ 75			
	Kg·m								
	ft·lb								
Operation	²⁴³								

Description	F3 675	F3 ORO
REAR SUSPENSION		
Type	Progressive, single shock absorber with rebound-compression damping and spring preload adjustment	
Swingarm	Aluminium alloy	Aluminium alloy
Wheel travel (mm)	123	107

During the disassembly and check of the rear suspension assembly, it is advisable to disassemble the under-engine fairing, fairing side panels, tail unit and fuel tank as described in chapter C "Bodywork".



Suspension and wheels

Rear shock absorber disassembly

Remove the seats, side panels, tank and rear panels as described in Chapter C "Fairings".

Lift up the rear part of the motorcycle with the specific lifter.



F Slacken the upper nut (1) of the shock absorber.

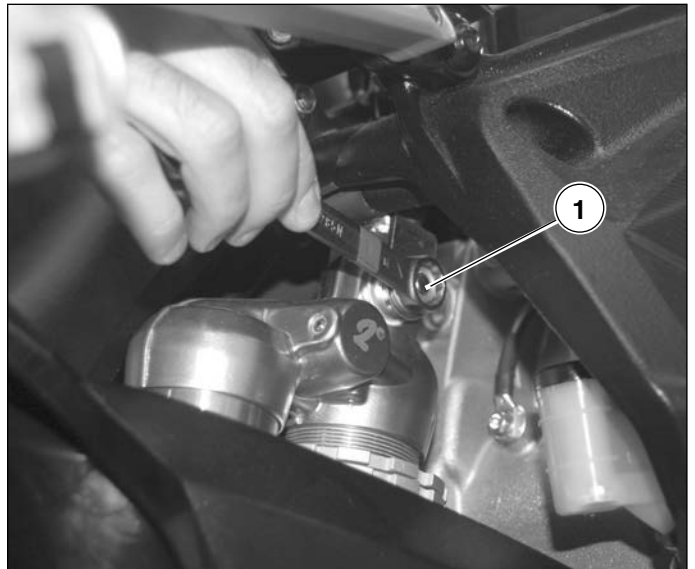

Using a screwdriver push the screw (2) outwards.

Unload the weight onto the damper and remove the screw as shown in the picture.

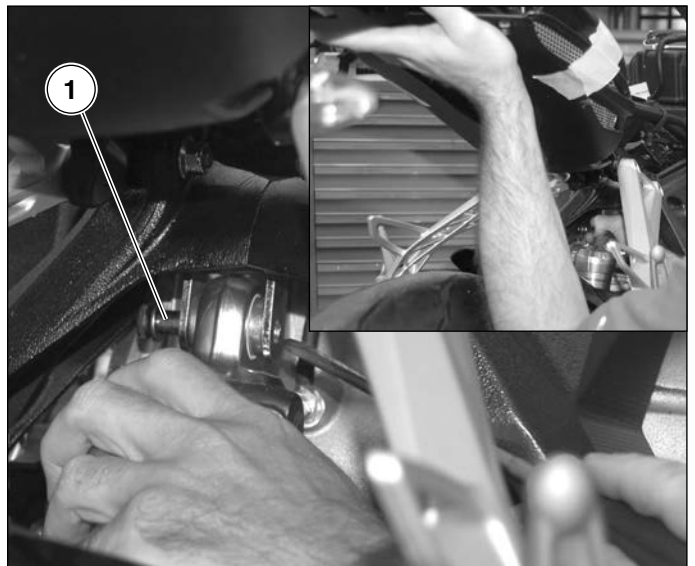



Suspension and wheels

Remove the bottom nut (2) of the damper and slide the screw out.

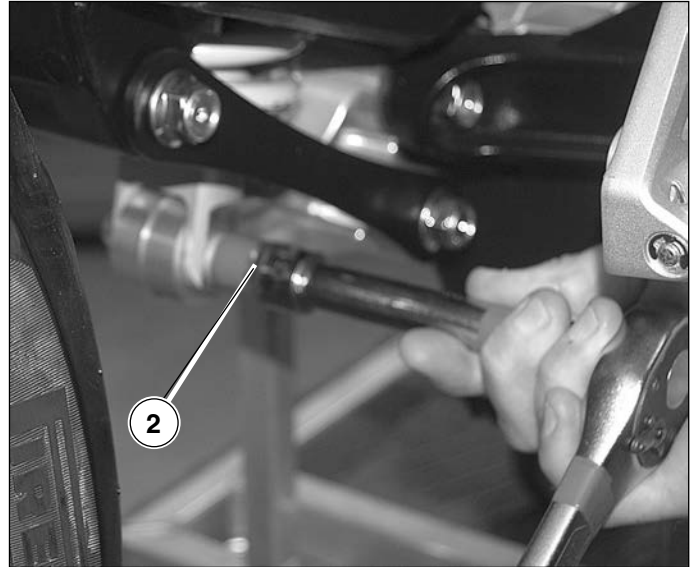

Take out the complete damper.



Rear shock absorber test

Make sure that the top connection of the damper (ball joint) does not have any axial (A) or radial (B) play.

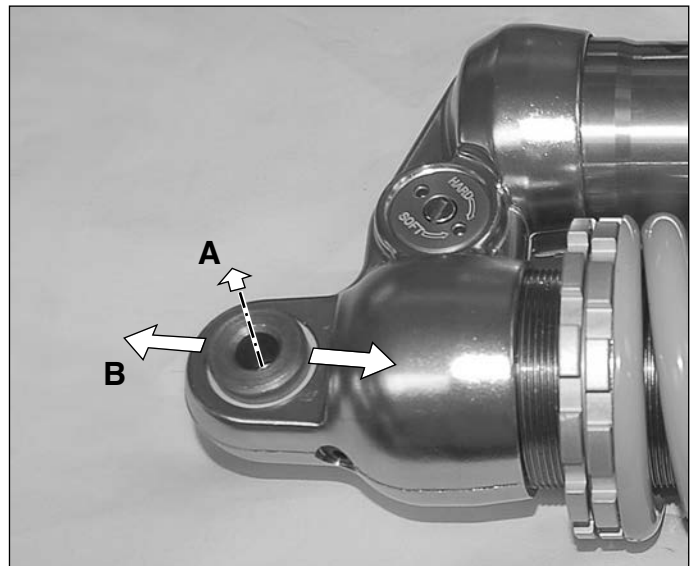



Suspension and wheels

Check the length of the rear shock absorber spring.

Standard spring adjustment (A):

- F3 675 (on road): A = 161,5 mm
- F3 675 (on race track): A = 160,5 mm
- F3 ORO: A = 142 mm

Check the functioning of the adjusters.

⚠ The shock absorber contains high-pressure gas. Do not touch the valve of the shock absorber tank. Do not try to disassemble the shock absorber.

Spring preload and rebound and compression damping for the rear shock absorber:

	Type of set-up		
	F3 675		F3 ORO
	On road	On race track	
Rebound damping	2,5 rounds	2,5 rounds	15 clicks
Compression damping	1 round	1 round	20 clicks

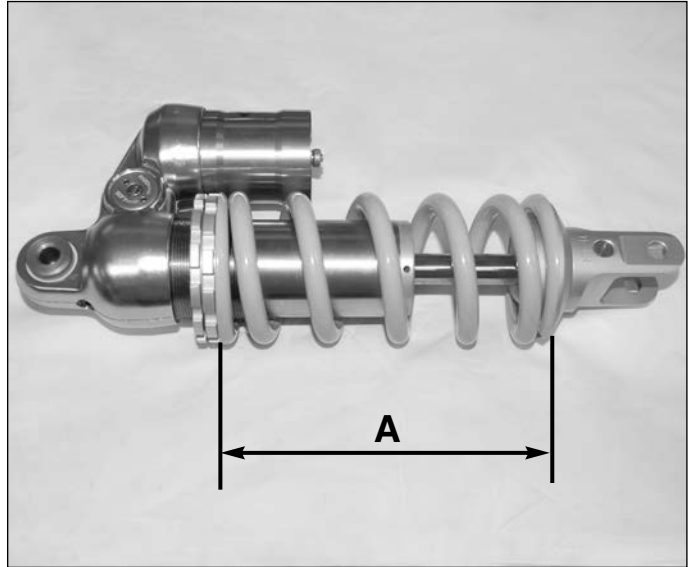

NOTE Adjustments contained in the table must be carried out from initial reference positions. These positions must be determined by means of the following procedures:

- **Extended brake:** Turn clockwise to end stroke, then turn counter-clockwise to the standard position (see table).
- **Compressed brake:** Turn clockwise to end stroke, then turn counter-clockwise to the standard position (see table).

NOTE The following operations can be also carried out with the rear shock absorber assembled to the motorcycle. For further tests on the ball joints of rear shock absorber attachments, it is necessary to follow disassembly phases described in this chapter.

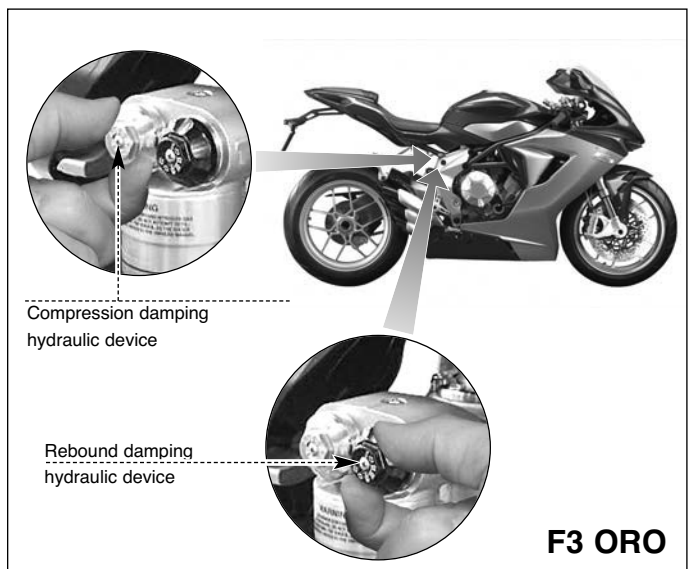
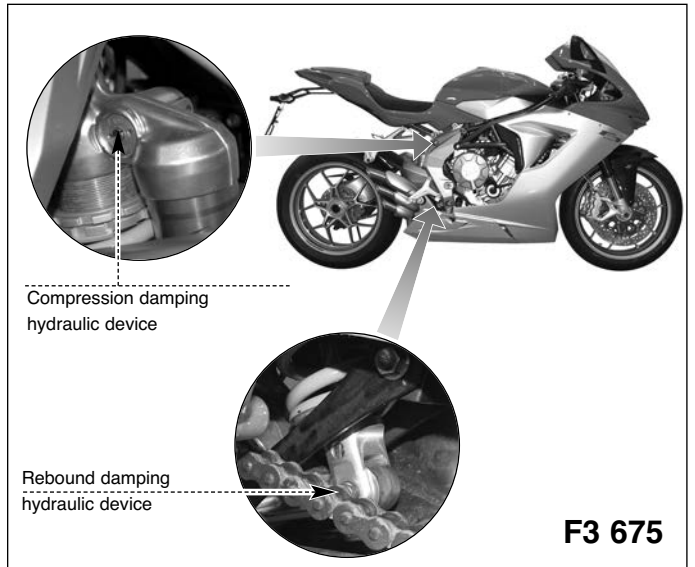

Rear shock absorber assembly

Accurately clean all parts. Grease the screws with Agip Grease 30 before reassembly.

Insert the shock absorber from above and lightly screw in the lower screw of the shock absorber using the relative nut.

Insert the shock absorber into the compensator assembly and lightly screw in the screw using the relative nut.



Lower the motorcycle to the ground, remove the lift and safety straps.

This operation is necessary to recover the play between the shock absorber/compensator assembly/mono-arm fork.



Recommended grease: Agip Grease 30

Tighten the bottom (1) and top (2) damper nut holding the screw on the opposite side still.



Grease only the screw thread.



Recommended grease: Agip Grease 30



Shock absorber torque pressure $40 \div 44$ N·m

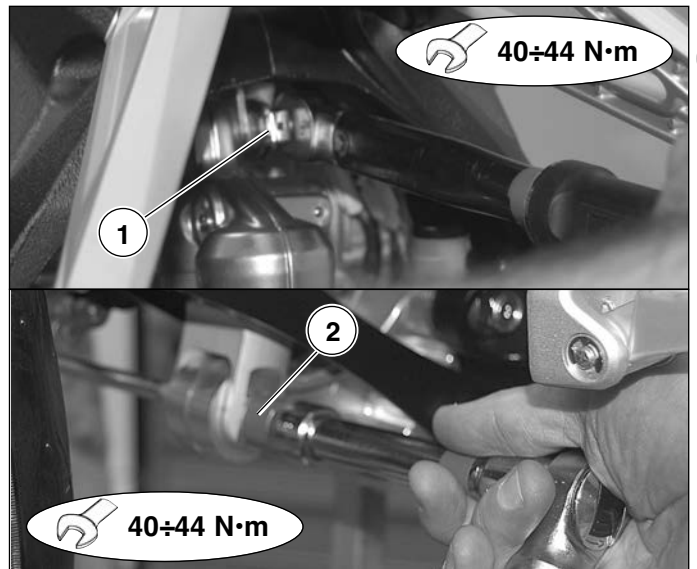



Suspension and wheels

SWINGARM REMOVAL AND OVERHAUL

Remove the rear damper as described in the previous pages.

Rear wheel removal

Remove the rubber and the safety spring clip (1) and unscrew the screw ring of the wheel.

 **Attention!** The screw ring has a left-handed thread.



Footrest removal

F Before disassembling the left foot peg remove the clamping screw (1) from the gear extension.

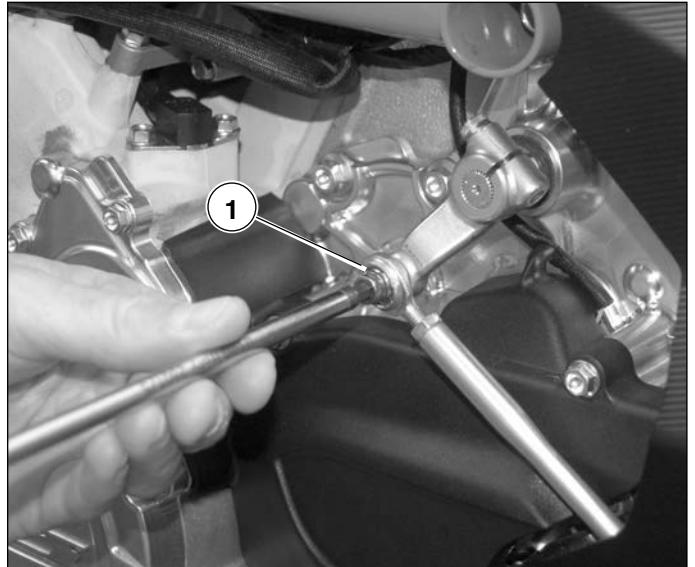

On the right foot peg, also remove the silencer clamping screw (2).





Suspension and wheels

Unscrew the two screws (1) of both footrest supports and remove them.

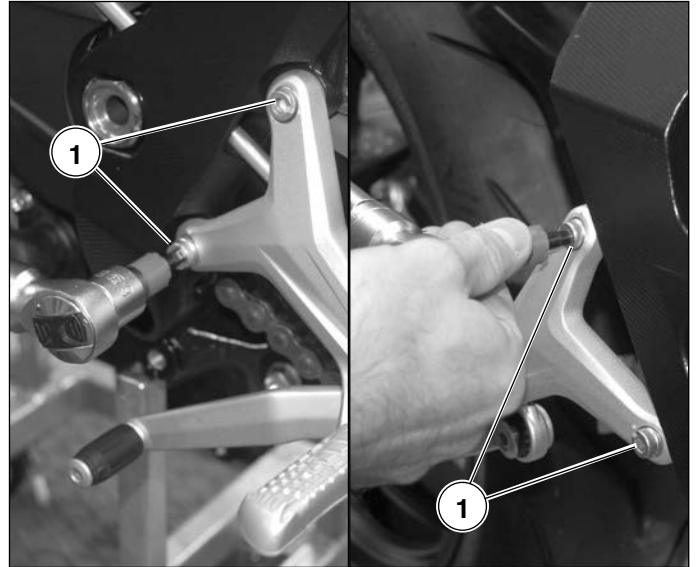

Passenger footrest removal

Remove the passenger foot pegs by acting on the 2 relative screws for each side.



Lower chain guard removal

Remove the two socket head screws (1) of the lower chain guard.

Remove the lower chain guard, taking care to recover the internal bushes.

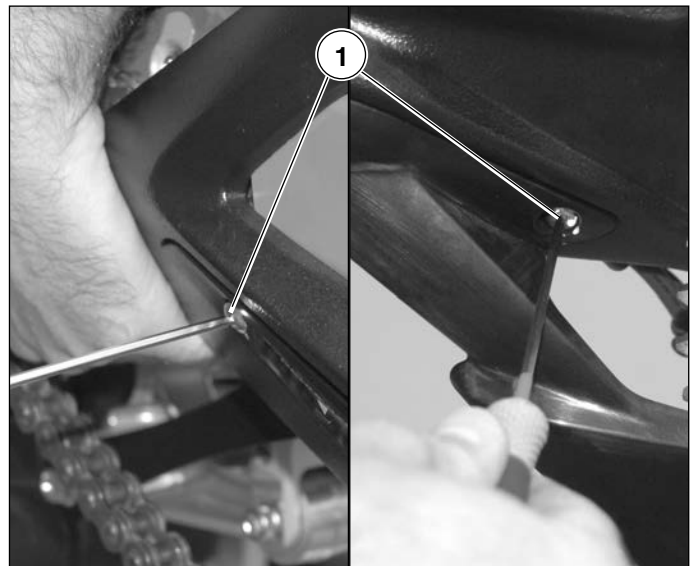



Suspension and wheels

Top chain guard removal

Remove the two top chain guard screws (1).

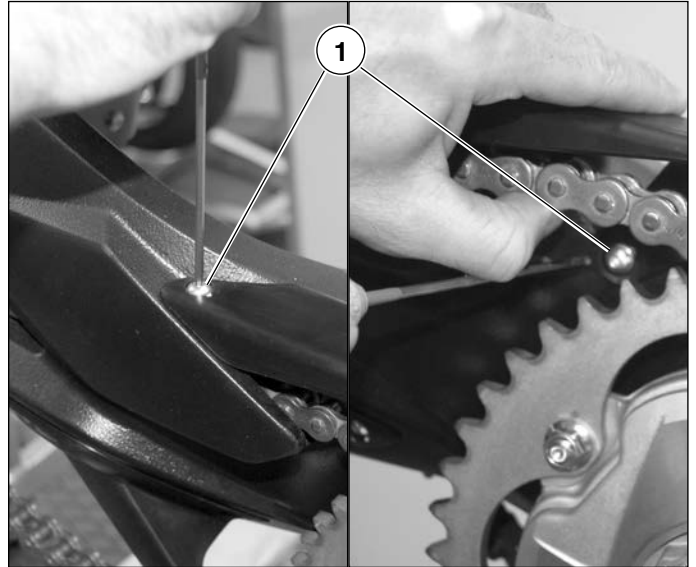

Silencer disassembly

Remove the clamping screw on the lh side.



Remove the socket head screw on the right side holding the nut still with a 10mm wrench.



Remove the silencers unit from the exhausts.



CHAIN REMOVAL

Remove the chain utilising the special tool.



Special tool N. 800095389.

Identify the connecting link.

The part of the tool being indicated must operate on the internal part of the crown wheel.

NOTE The tool has three functions:

- As a chain cutter: with a punch mounted aligned at A.
- Press fitting of connecting link plate: with a raised punch aligned at A.
- As an anvil: with a raised punch aligned at B.

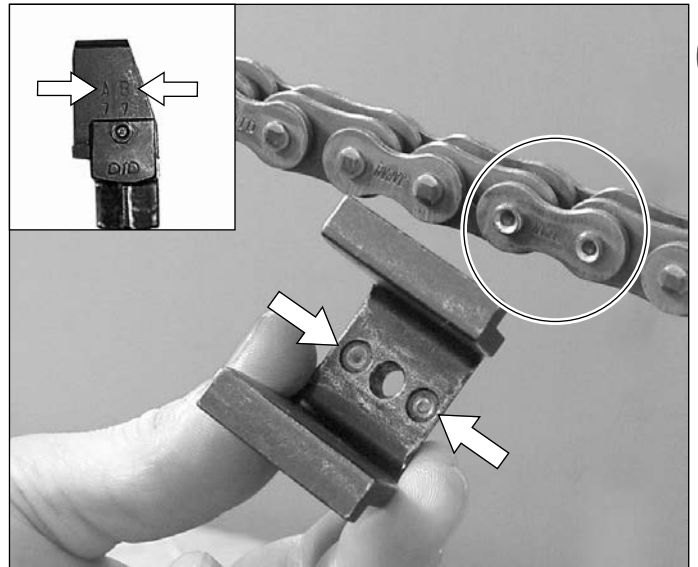

Pre-assemble the tool as shown in the figure. Align a pin with the central hole of the tool.

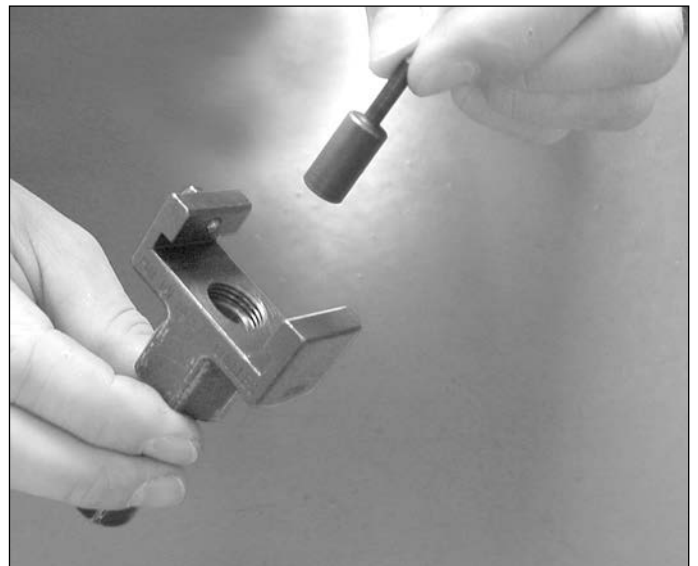



Mount the tool onto the chain as shown in the figure and align the punch on «A».
Operate as shown in the figure, removing both pins from the connecting link.

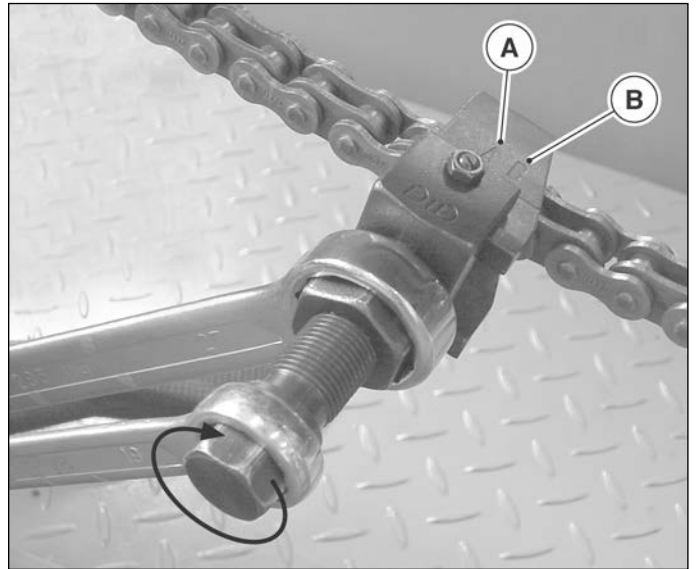

F How to fit the chain back in

Before reassembling the chain, grease the connecting pins and the O-Rings as shown in the figure, by using the special grease supplied with the chain kit.

 **Utilise only new links.**

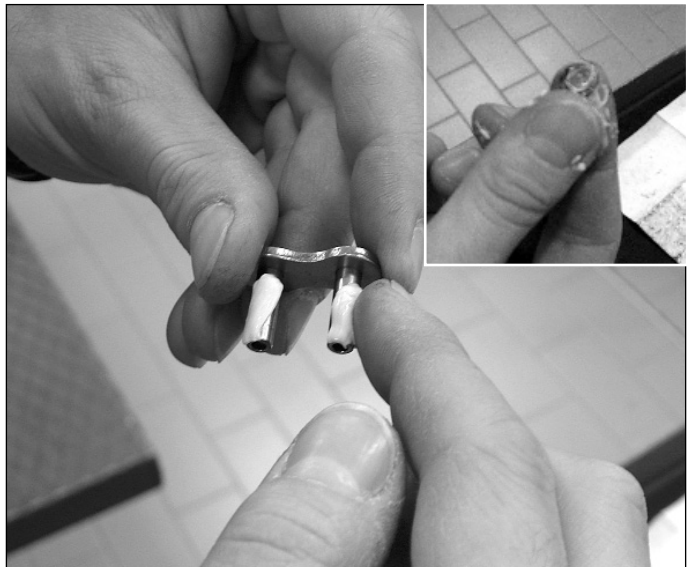

Connect both ends of the chain with the connecting link, and press the connecting plate into the connecting pins by hand.

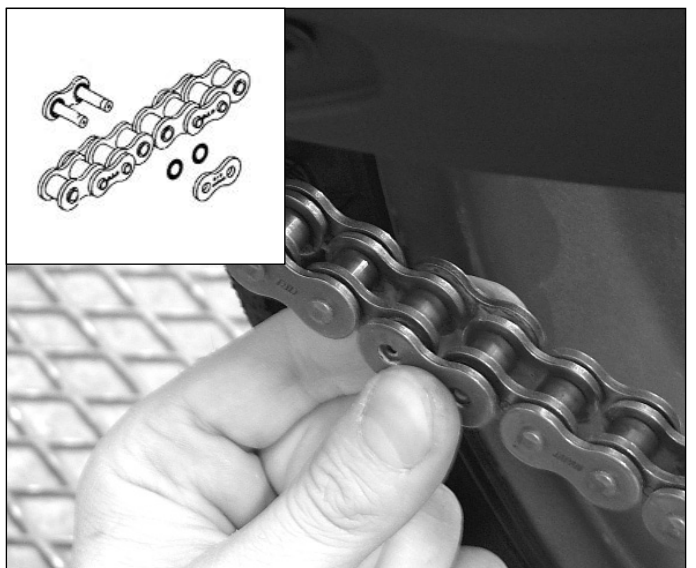



Suspension and wheels

Fit the punch and the plate holder on the tool as shown in the figure.

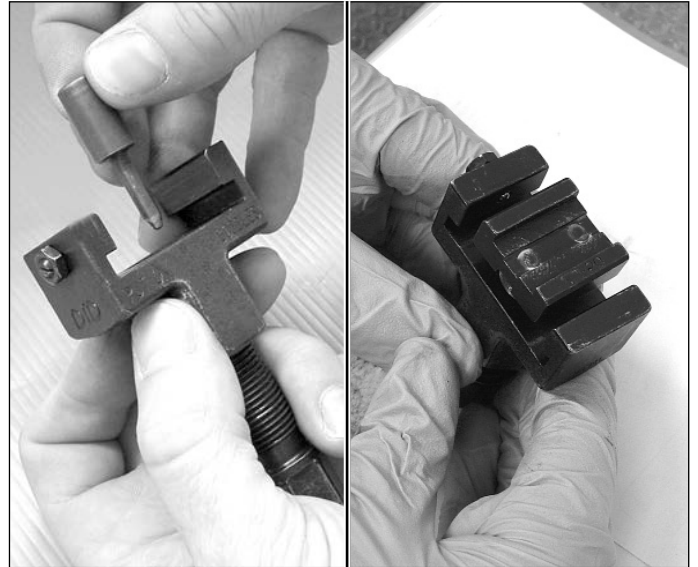

Mount the tool onto the chain as shown in the figure and align the punch on «A».

Turn the pin holder by hand until the plate holder contacts with the connecting link plate.

Tighten at the specified torque.



Connecting link plate press fitting torque pressure:
30 ÷ 35 N·m

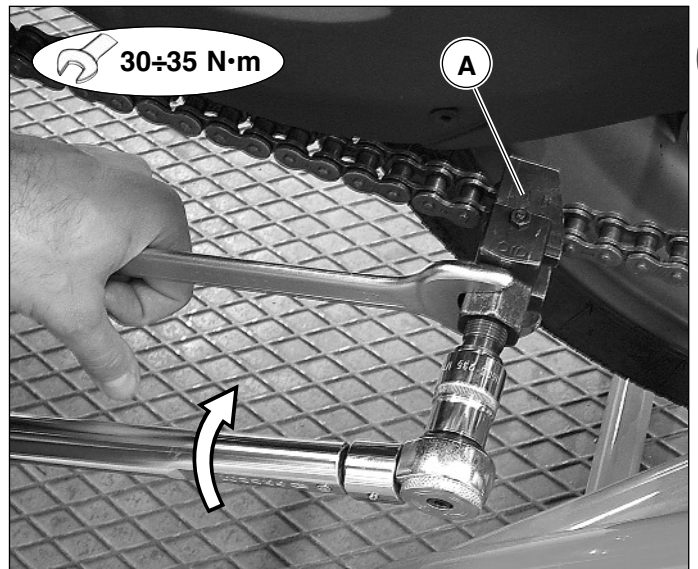

F

Riveting of pin

Pull out the plate holder from the tool, keeping the punch in the position used in the previous operation.

Mount the tool onto one of the pins of the connecting link as shown in the figure and align the punch on «B».

Turn the pin holder by hand until the punch contacts with the pin. Check that the punch and the pin are correctly aligned.

Tighten at the specified torque.



Pin riveting torque pressure:
45 ÷ 50 N·m

Repeat the above operations for the second pin of the connecting link.

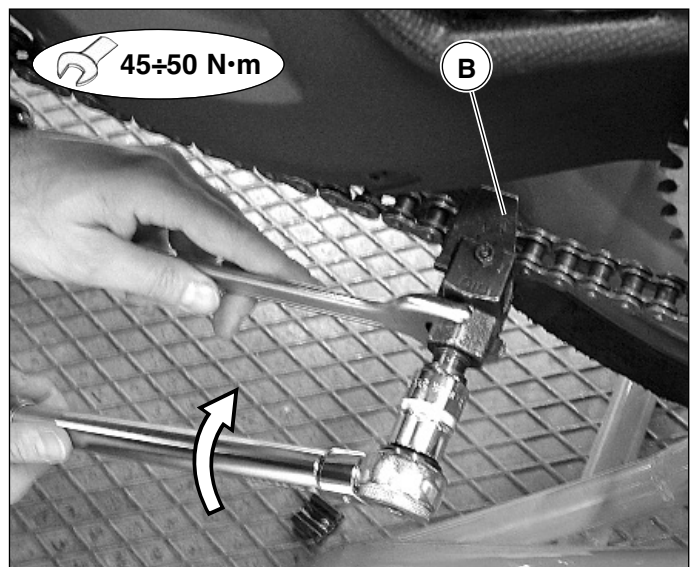



Suspension and wheels

When the riveting is over, check if the diameter of the head of both pins is between the following range:

- **Pin head diameter after riveting:**
 $d = \text{Ø } 5.5 \text{ mm}$

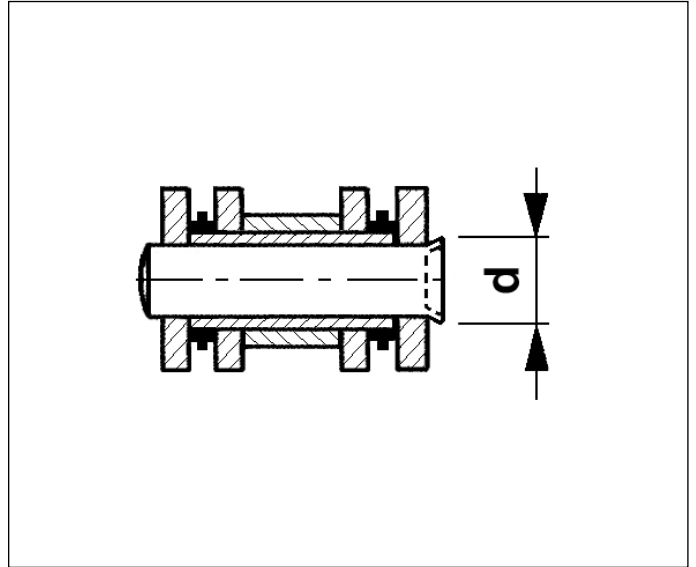

F Removing the rear brake caliper

Loosen the two screws (1) and remove brake caliper (2).

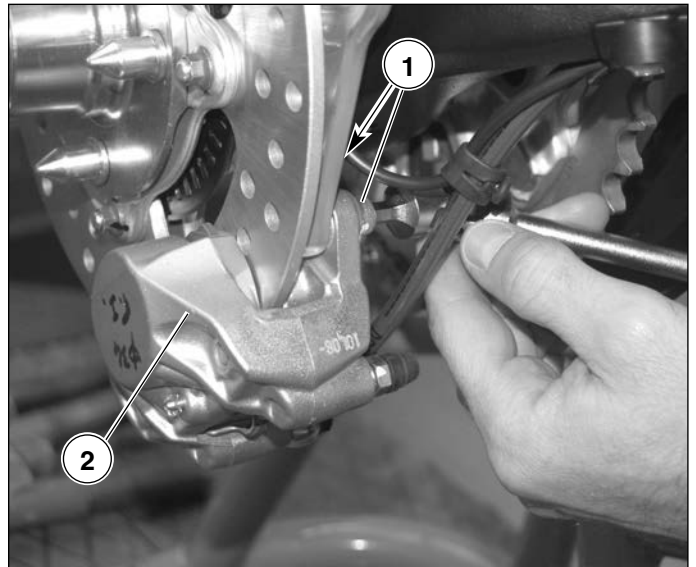

Speed sensor cable disassembly

Remove the speed sensor cable holding clamp (3).





Disconnect the speed sensor cable connector (1).

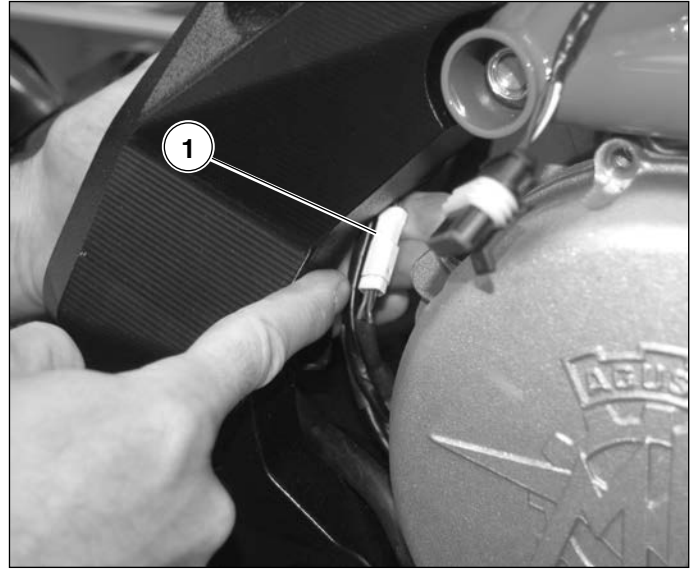

Swingarm pin removal

Before removing the swingarm pin, loosen the suspension rocker pin (1) and the two engine pins (2). (See chapter G "Frame").

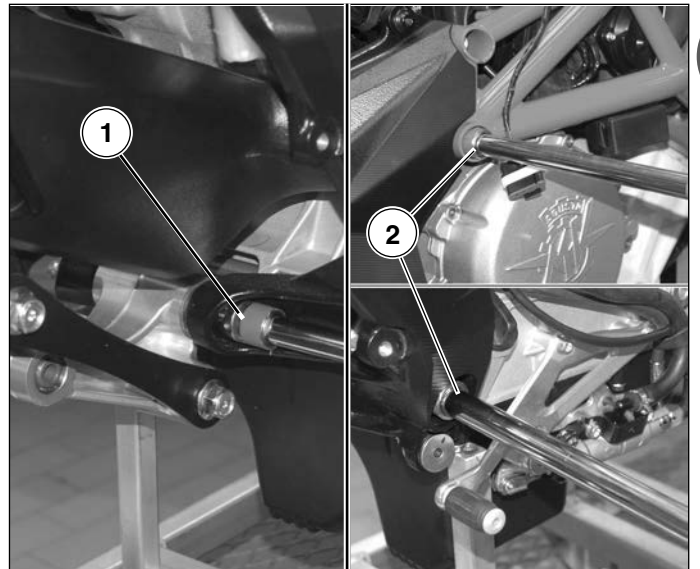

Also loosen the pin for the pads.



F



Suspension and wheels

Remove the screw (1) on the left side of the vehicle.
Remove the washer and push out the pin **manually**.

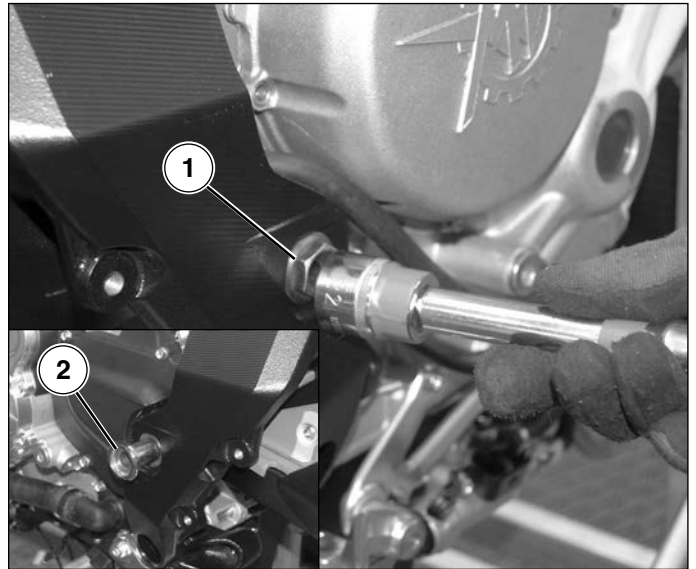

F At this point slide out the rocker arm pin (3).
Support the swing arm to avoid it from falling on the ground and slide it towards the rear part of the motorcycle.

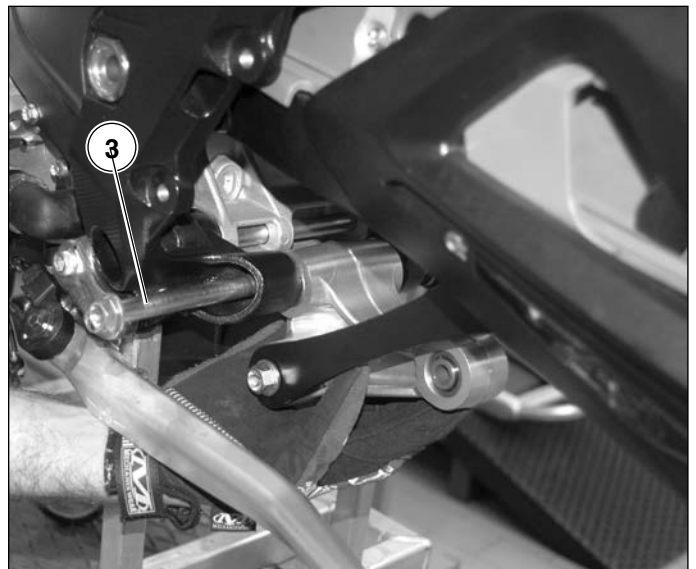

Upper chain guide removal

Remove the 2 screws (1) and relative plates and the screw (2) on the front.

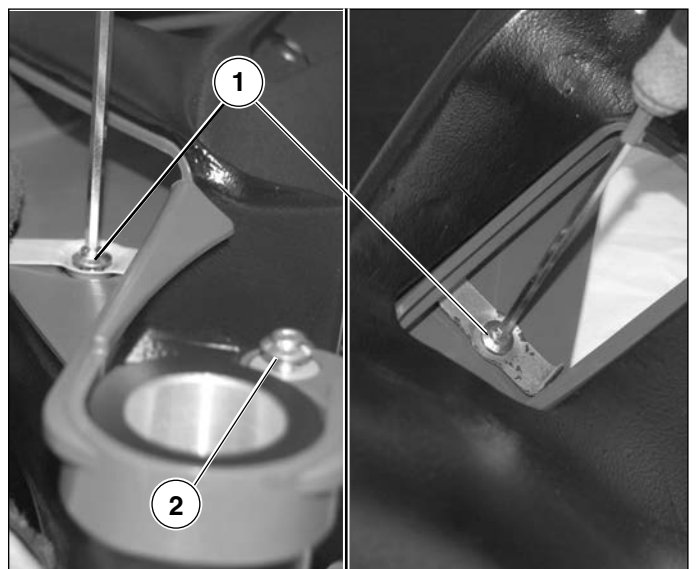



Suspension and wheels

Lift up the front part of the chain guide to remove it from the swingarm (see figure).

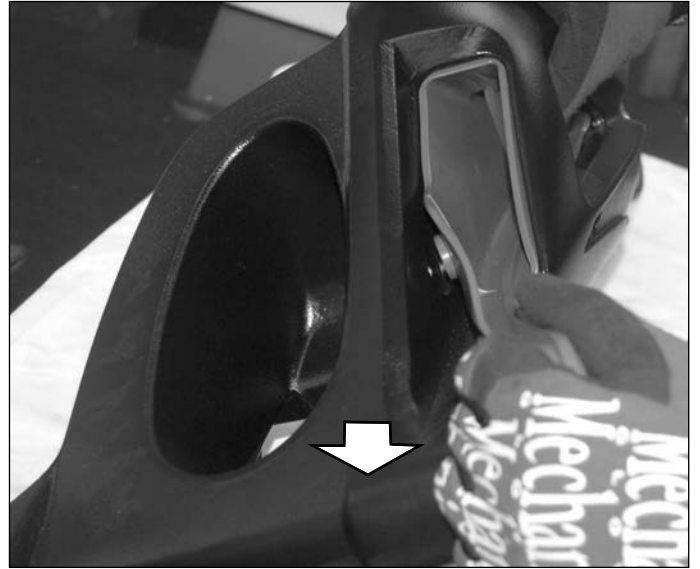

Slide out in a forward position as shown in the figure. During re-assembly, proceed in reverse order making sure that the two front and rear reference elliptical elements are in the correct position.

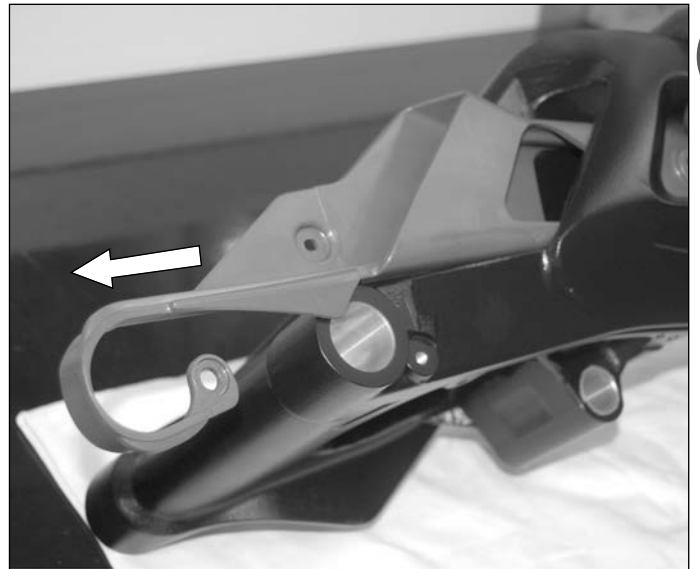

Lower chain guide removal

Remove the 3 screws (1) with their relative spacers.

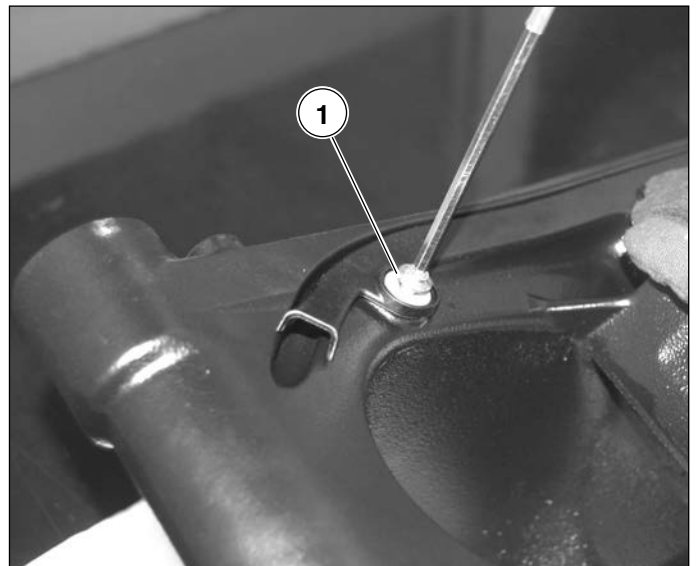

Bearings overhaul

If it is necessary to substitute the bearings of the swingarm because of excessive play, operate as follows:
Remove the right and left spacer.

Remove the Seeger retaining ring on the right side of the swingarm.

Remove the anti-dust seal on the left side.

Utilising the special tool, remove the two roller bearing units.



Special tool N. 800092860 LEFT SIDE



Mount the tool so that both roller bearings are removed.



Utilising the special tool press on both ball bearings and extract them.

Operate in the same way for the bearings on the left side.



Special tool N. 800092860 RIGHT SIDE



Extract the spacer from the right side.

Check the condition of both bearing seats and the seat of the spacer.

If the spacer is in good condition, reinsert it onto the fork from the right side.





Suspension and wheels

Fitting the bearings and the roller cases on the rear swingarm.

Take two new roller cases (Part No. 800084936) and two new ball bearings (Part No. 800084938).

Preassemble the 2 roller cases (Part No. 800084936) on specific tool **Part No. 800092866** (see figure).

Fit the assembly to the left side of the swingarm.

Assembly the inner bearing spacer (Part No. 800084872) and the two ball bearings (Part No. 800084938) on the tool Part No. 800092866 on the right side of the swingarm (see figure).

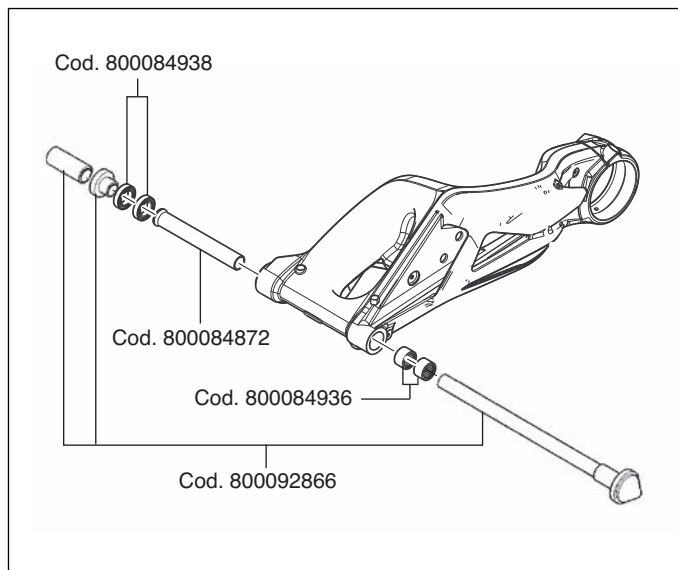

Complete the assembly by fitting the two bushings relating to the tool **Part No. 800092866** on the right side of the swingarm.



Special tool no. 800092866



F

Utilising a press fit the bearings and the roller bearing units (see figure).

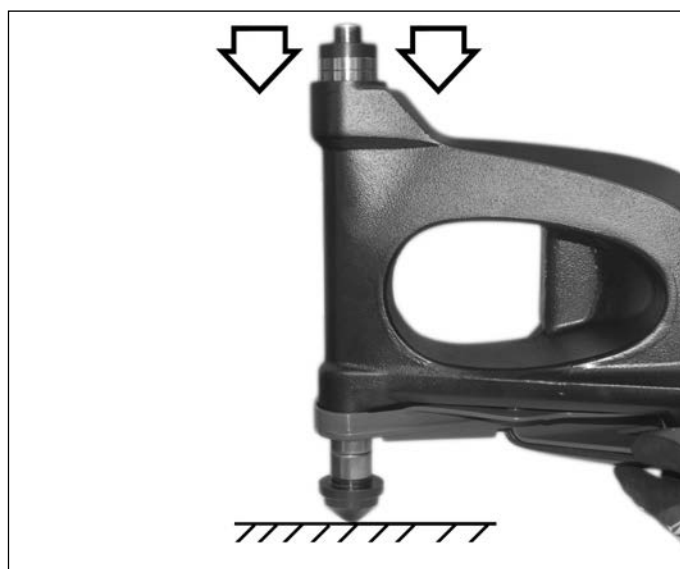

REAR WHEEL HUB

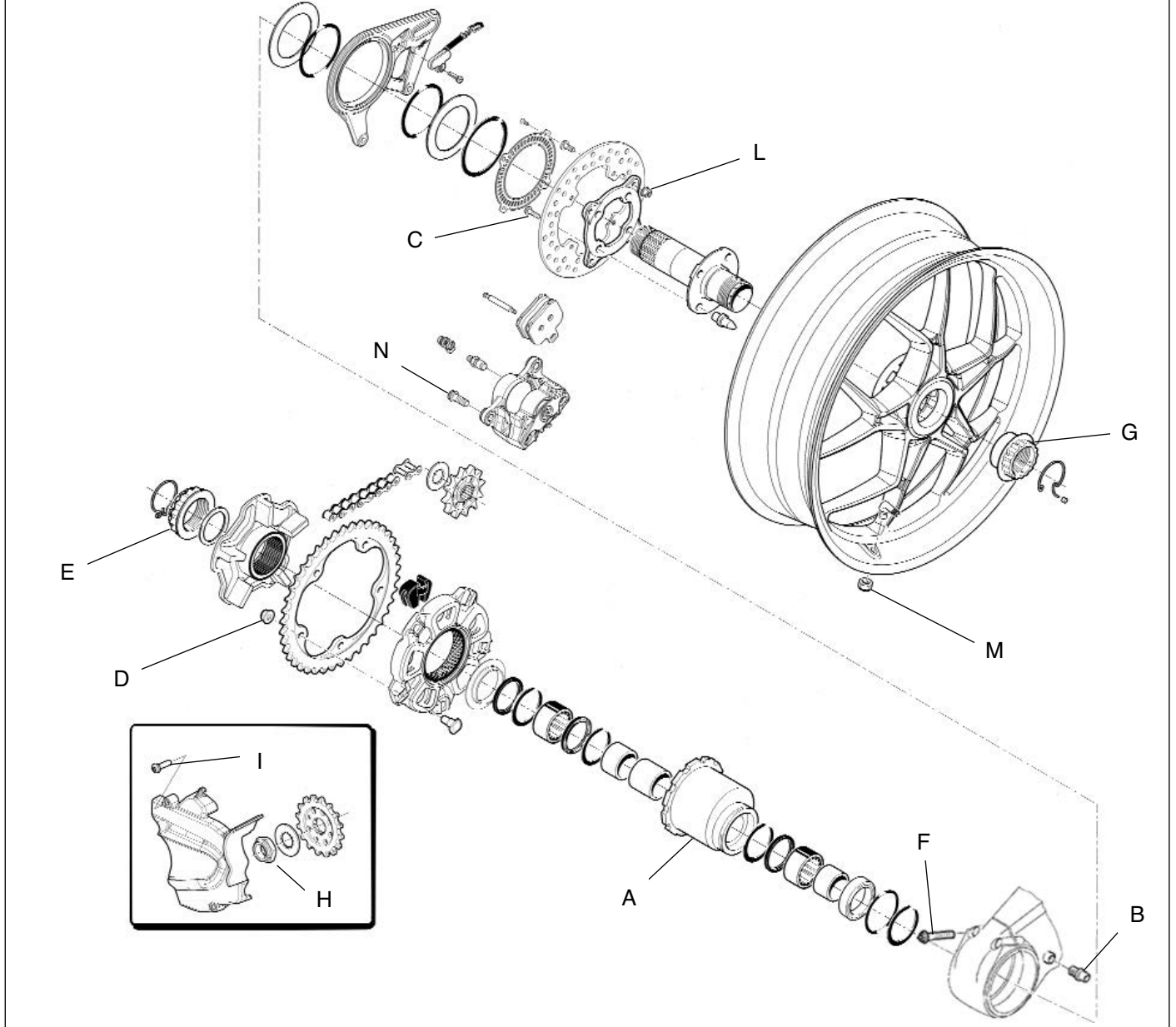

	A	B	C	D	E	F	G	H	I	L	M	N		
Torque pressure	N·m	30÷35	20÷22	25	200÷220	28÷32	220÷240	140	10	18÷20	5÷7	18		
	Kg·m													
	ft·lb													
Operation		243	270						270	270		243		

Description	F3 675	F3 ORO
REAR WHEEL		
Material	Aluminium alloy	Forged Aluminium alloy
Dimensions	5,50" x 17"	
REAR TYRE		
Dimensions	180/55 ZR 17 M/C (73W)	
Brand and type	PIRELLI - Diablo Rosso Corsa	
Rear tyre pressure:	2.3 bar (33 psi)	

Before checking and overhauling the rear wheel hub assembly it is necessary to carry out the following preliminary operations:

Place the motorcycle on the rear stand.



Special tool no. 800092642

Remove the rear wheel by removing the polygonal nut. Utilise the following tools:



• **Torque wrench 55 mm polygonal spanner**



The polygonal fixing nut of the rear wheel has a left hand thread. To effectuate the removal it is therefore necessary to turn the torque wrench in a clockwise direction as shown in the figure.

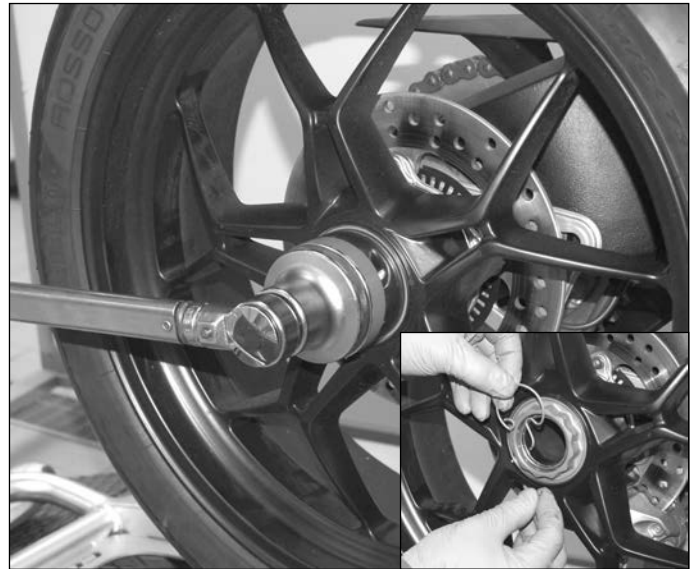

After having effectuated the rear wheel removal, support the motorcycle with a lift as shown in the figure. Remove the rear stand.



F

Remove the safety ring (1) of the crown flange-fixing nut.

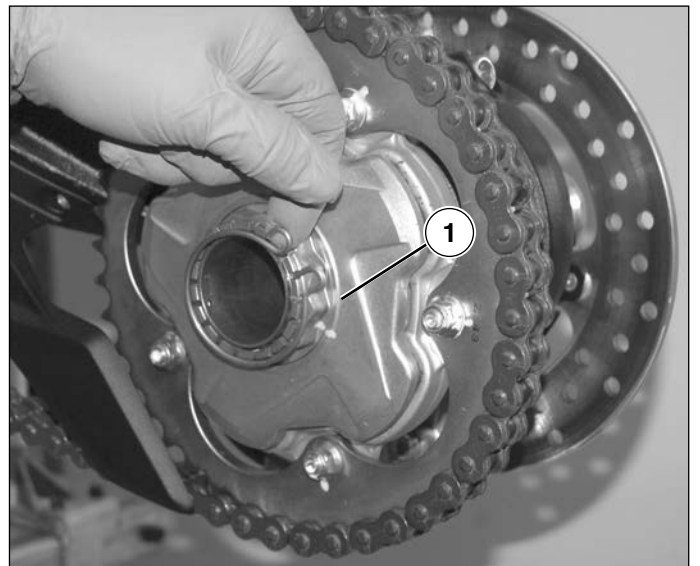



Suspension and wheels

Slacken the nut of the flange by rotating it in an anti-clockwise direction as shown in the figure. Utilise the following tools:

- Torque wrench
- 55 mm polygonal spanner



F Remove the nut (1) with the shim (2) underneath.

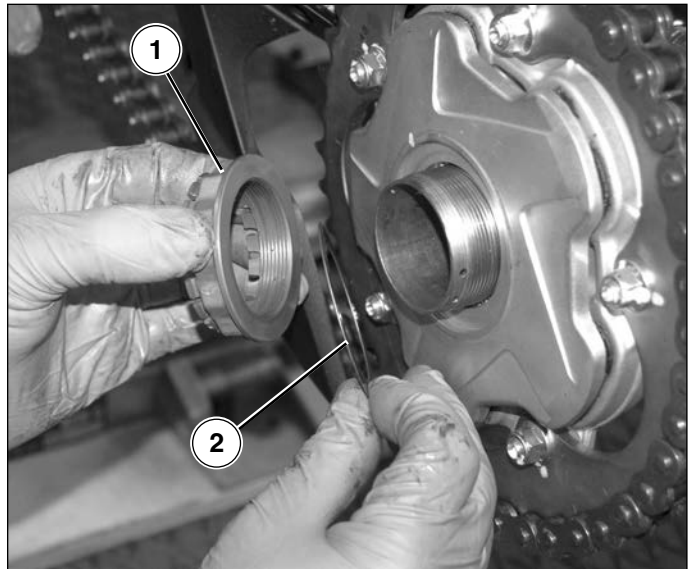

Slacken the fixings (1) of the wheel hub.





Suspension and wheels

With the special spanner mounted on the extension tube, pull forward the eccentric adjuster and slacken the chain.



Special tool:

Eccentric adjuster spanner
Spanner extension

N. 800092854
N. 800092855

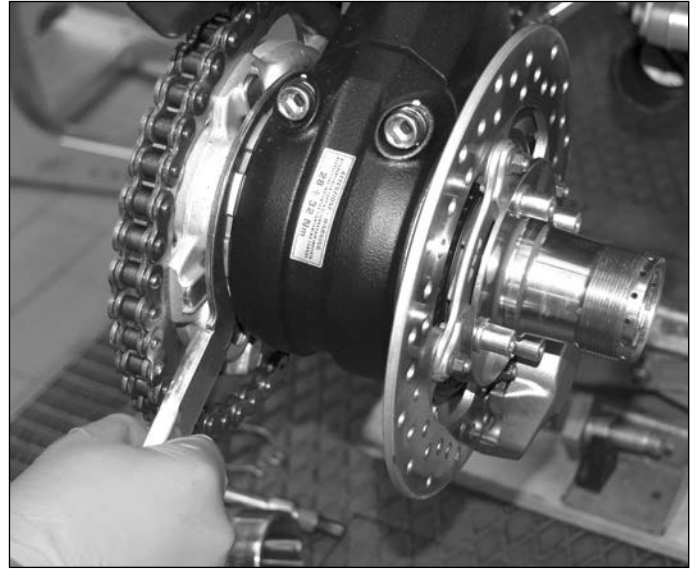

Remove the rear sprocket unit (3) and the spacer ring (5) underneath.

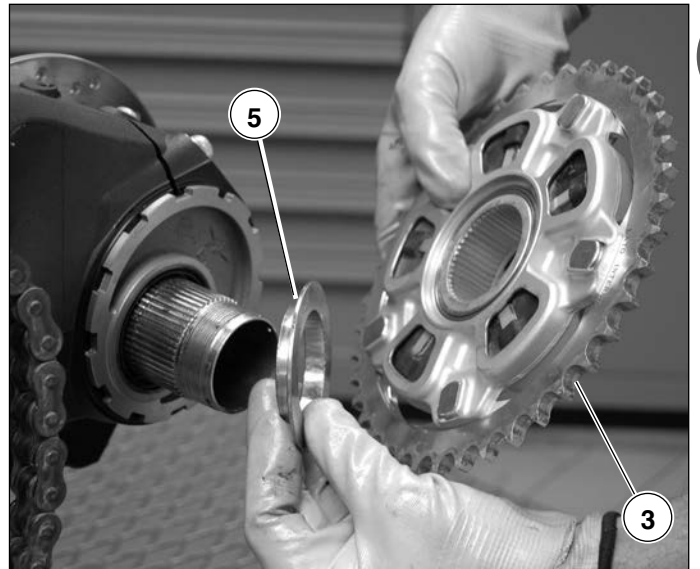

Remove the rubber clamp (1) around the rear brake pipe.

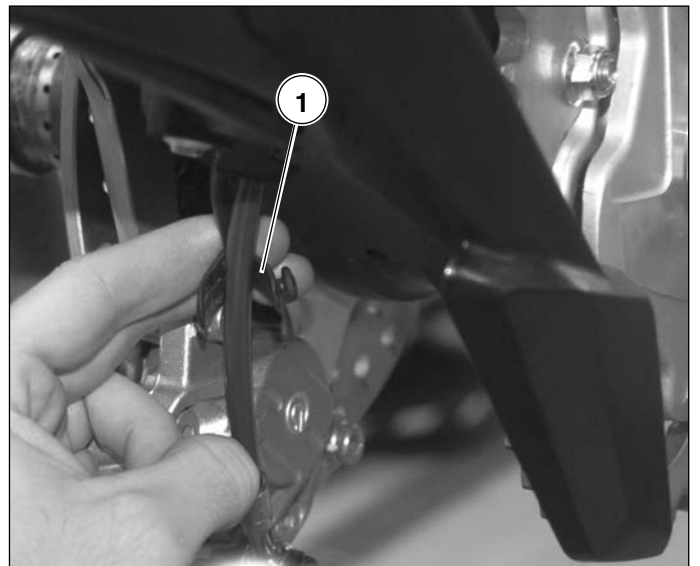

F



Suspension and wheels

Slacken the two screws (6) and remove the brake caliper (7).

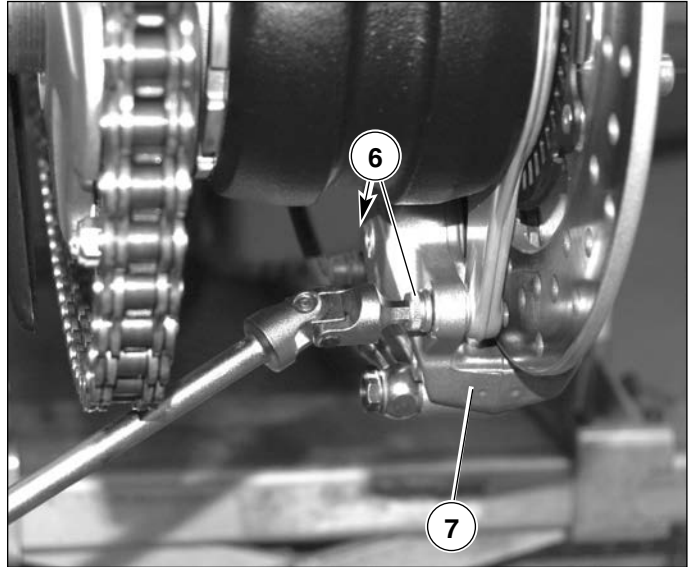

Disassembly of the wheel pin

Remove the wheel spindle complete with the brake disc, extracting it from the right side of the motorcycle as shown in the figure.

At the same time, support the ring gear unit with one hand.

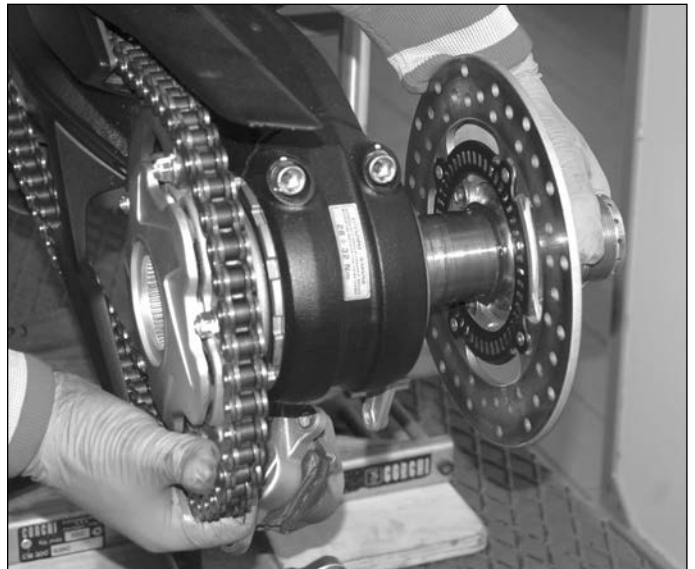

Brake caliper support flange removal

Remove the Seeger retaining ring (1), the spacer ring (2), the flange (3) and the spacer ring underneath.

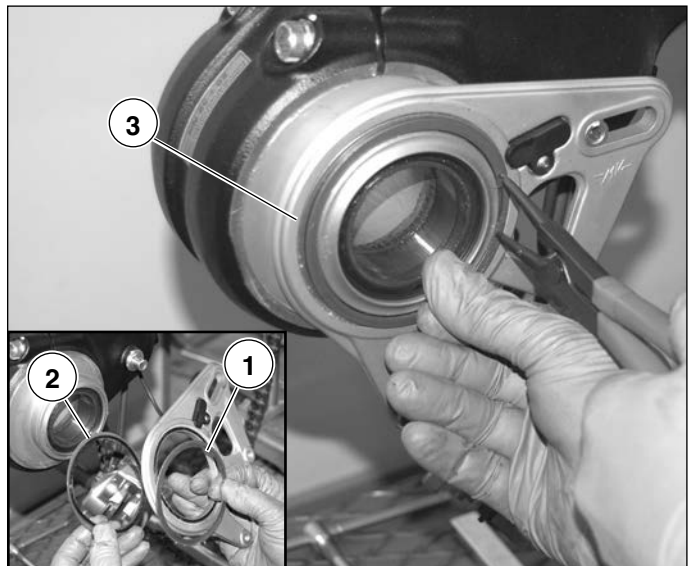

Wheel hub disassembly

Extract the wheel hub from the left side of the fork.

Carefully wash all parts.

Check the condition of the roller bearing and the ball bearing.

If there is excessive play (even only one of the bearings) or chamferings during rotation, substitute the wheel hub, complete with bearings with a new unit.



If only one bearing is worn, substitute the complete unit. Never substitute one bearing only.

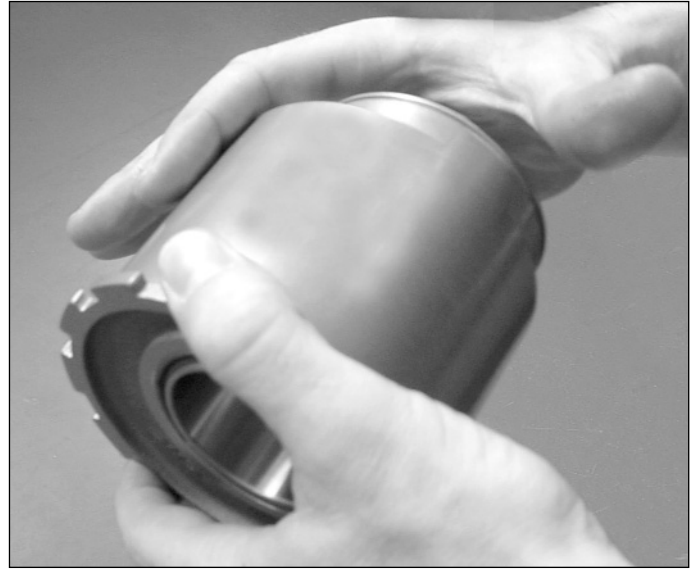

For normal maintenance, the ring gear spacer (1) and the three internal spacers (2) (wheel spindle seat), wash the roller bearing units, dry them and grease them.

Check the condition of the ball bearings.



The grease used must have the following characteristics:

- Lithium soap grease with a mineral oil base
- Consistency NLGI: 2
- Dripping point: 181° C
- Viscosity at 37.8°C: 140 cSt
- Temperature field: from -25°C to +120°C

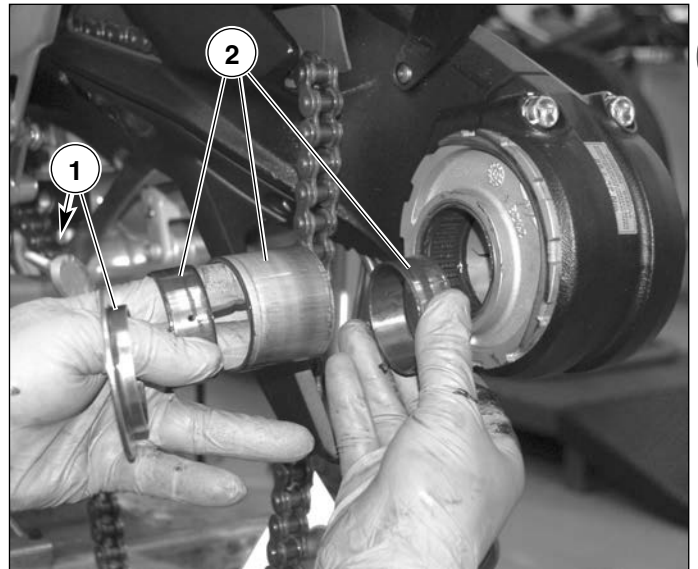

Caliper holder pin

NOTE Unscrew the caliper holder pin (1) only if it is damaged.

When reassembling apply the prescribed type of Loctite and tighten to the prescribed torque pressure.



Recommended thread-locking fluid: Loctite 243



Caliper holder pin torque pressure: 30 ÷ 35 N·m





Suspension and wheels

Wheel spindle unit check

Check the condition of the wheel drive engagement splines.

If it is worn, substitute as follows.

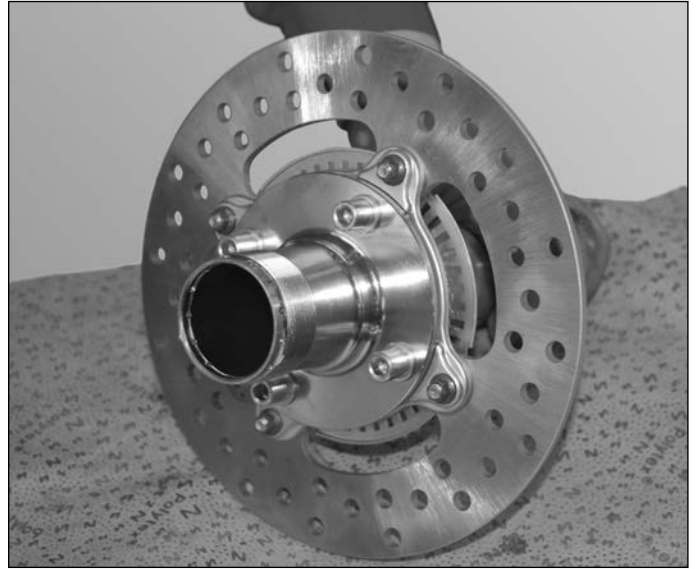

F Disassemble the phonic wheel by acting on the 4 screws (1).

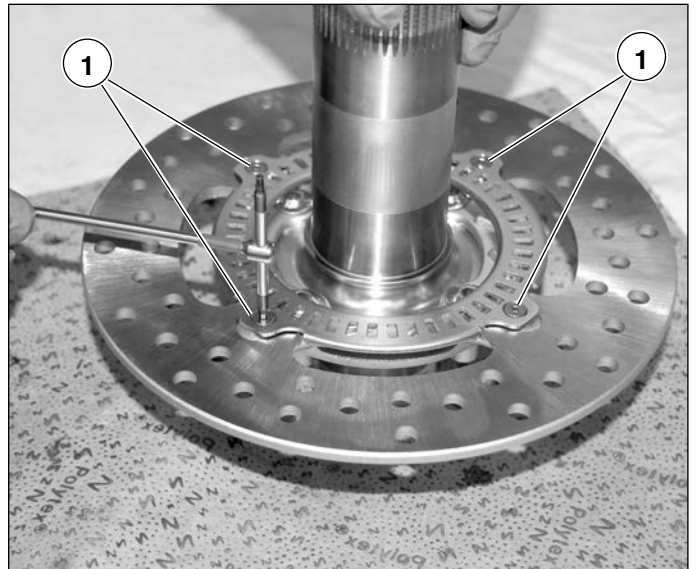

Remove the four clamping screws (1) of the brake disc holder flange, as they are usually assembled with threadlocker fluid, after having heated them with a heat gun.

Remove the flange itself.

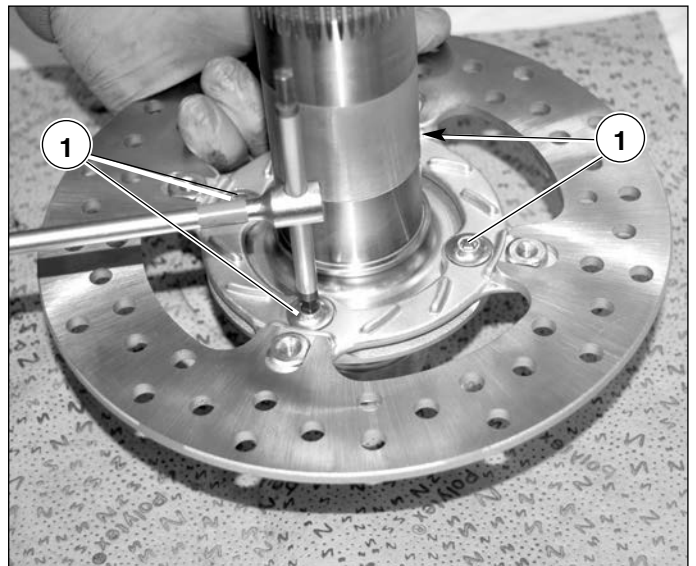

Check the extra-smooth parts of the wheel spindle for wear (A).

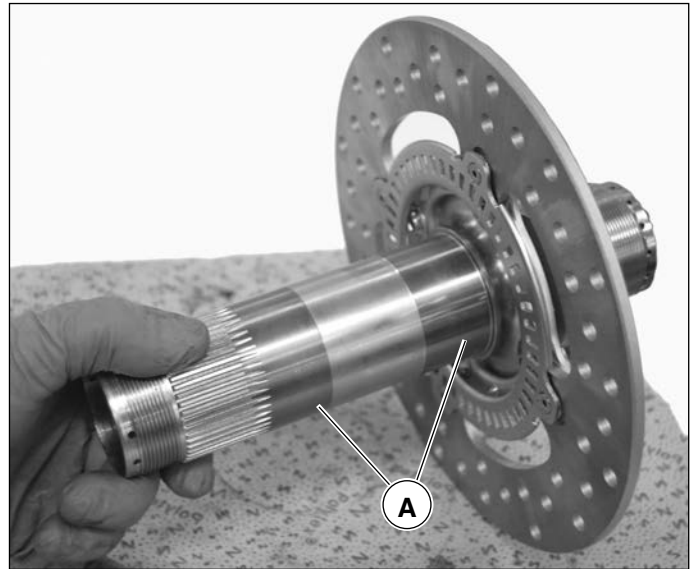

Utilising a press with an adequate punch for both the removal and assembly of the pins of the wheel drive engagement.

When assembling, apply force on the crown of the peg not on the point. (see figure).

Assemble the brake disc carrier plate by tightening the screws to the prescribed torque pressure and the recommended type of threadlocker fluid.



Recommended thread-locking fluid: Loctite 270



Brake disc carrier plate screw torque pressure: 20 ÷ 22 Nm



F

Crown wheel assembly check

Remove the driving flange (1) by pulling it upwards.





Suspension and wheels

Evaluate the state of wear of the ring gear. If it appears to be too worn, proceed as described in the following operation.

Flexible coupling check

Extract the 5 spring drives (2) from the gear flange support (3) and assess its condition.

If the spring drives are worn, replace with new ones.

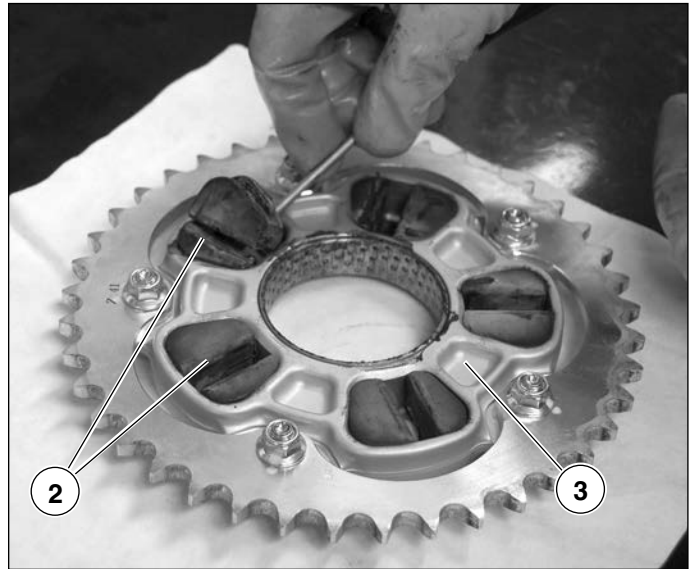

F Remove the 5 nuts (3) to free the crown (1) from the crown flange (2).

Replace the crown.

Remount the new crown on the crown flange, making sure the pins (4) enter the holes.

Screw the nuts back on to the required torque pressure.



Ring gear nuts torque pressure: 25 N·m

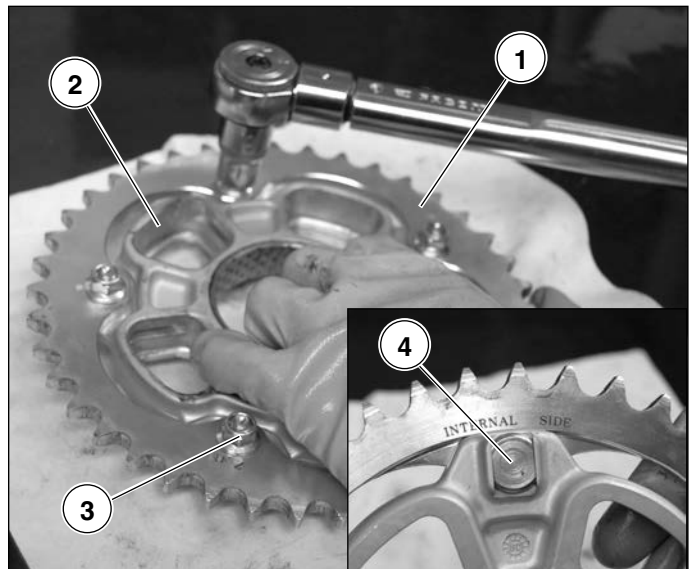

Check that the coupling bushes of the gear flange support (1) and the driving flange (2) do not show any signs of excessive or uneven wear.

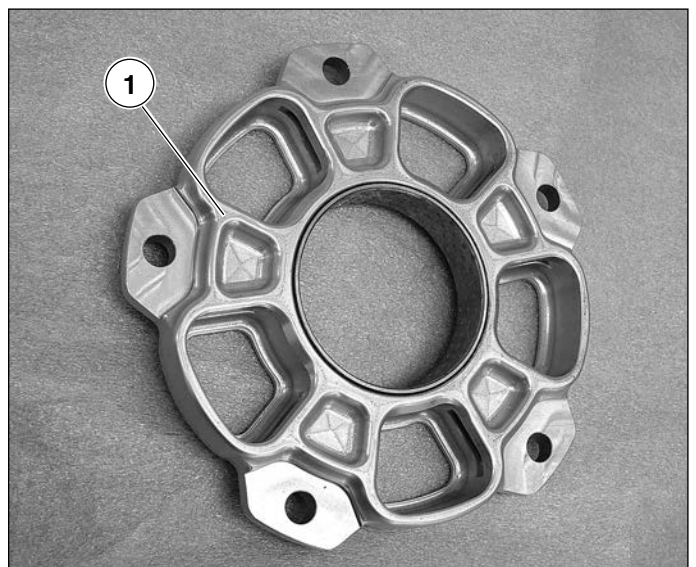



Suspension and wheels

If the bushes are excessively worn, replace the entire set of flanges.

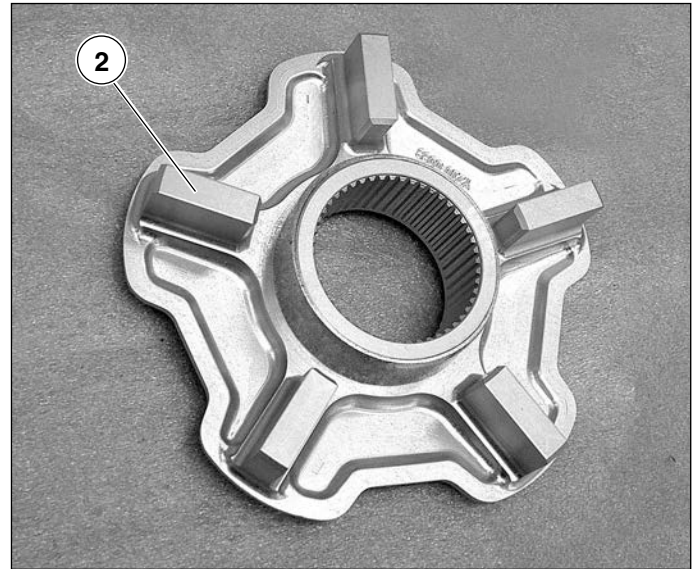

When the ring gear unit is being re-assembled with the drive flange unit, grease the coupling areas.



Bushes coupling area (1):

Grease AGIP GR SM

Bushes coupling area (2):

Grease AGIP GREASE 30



Do not apply grease to the threads of the pins.

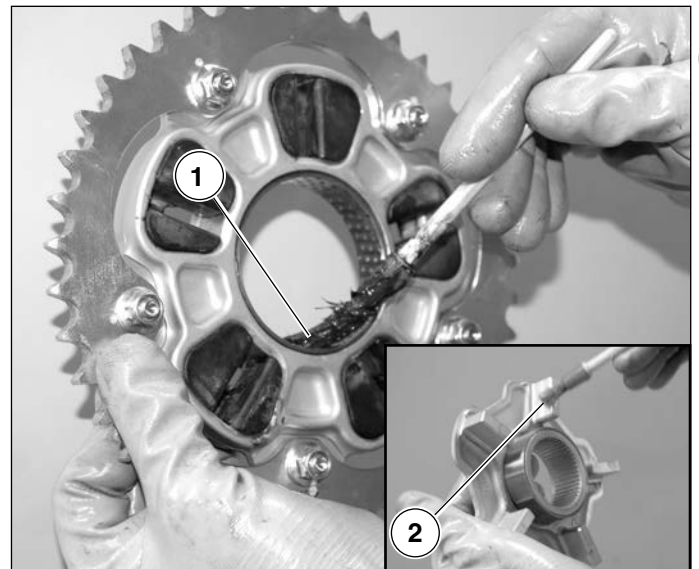

F

Reassembly wheel hub

Lightly grease the wheel hub.

Introduce the hub to the swingarm from the left side of the motorcycle and push it in.

Screw in the two screws on the swingarm without tightening.



Recommended grease: Agip Grease 30





Suspension and wheels

To assemble the brake caliper-carrying flange, carry out the following operations:

Grease the O-rings and insert them into their respective seats on the flange.

Assemble the rear spacer ring in contact with the hub, then the brake caliper-carrying flange (1), the second spacer ring and the Seeger retaining ring (1).

It is important to ensure that the Seeger retaining ring is inserted around the whole circumference of the seat.

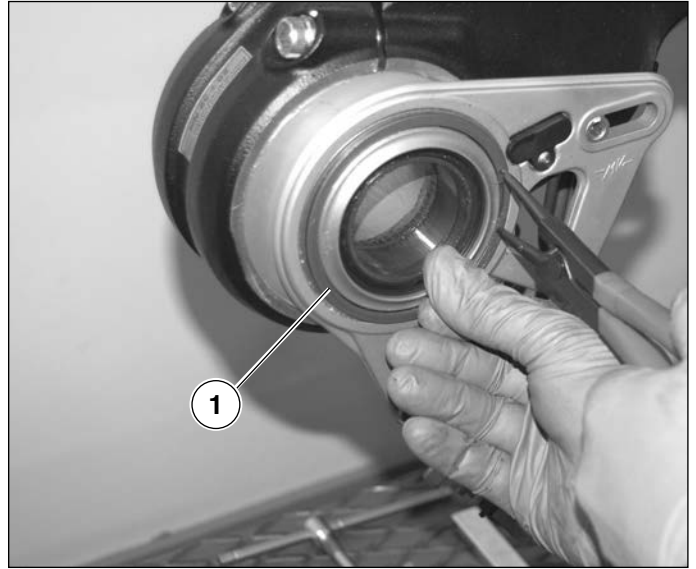

Grease the rollers bearings.

Introduce the first bush, the spacer and then the second bush.



The grease used must have the following characteristics:

- Lithium soap grease with a mineral oil base
- Consistency NLGI: 2
- Dripping point: 181° C
- Viscosity at 37.8°C: 140 cSt
- Temperature field: from -25°C to +120°C



Reassembly rear wheel pin

Grease the wheel pin in the two tracks where the bearings slide and gently insert it into the hub; at the same time, from the left side, position the ring gear unit that is already engaged on the chain. Finish inserting the wheel pin until you feel it reach the end.

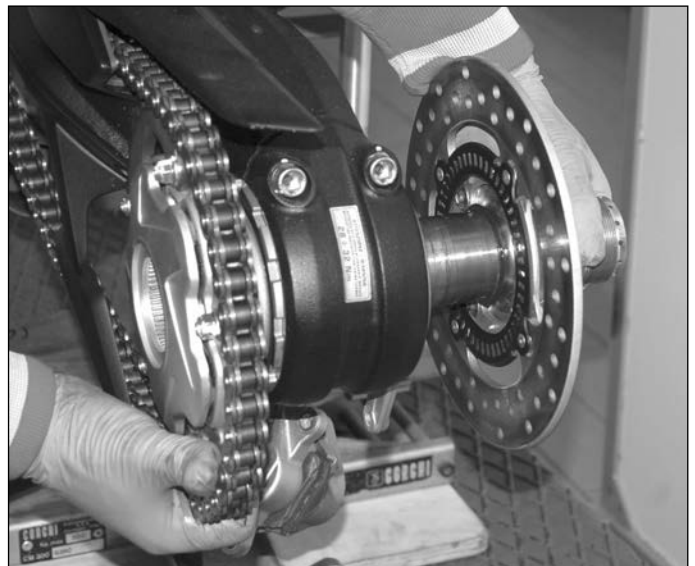



Suspension and wheels

Reassemble the brake caliper (1) and tighten the fixing screws (2) at the specified torque.



Special product: Loctite 243



Torque pressure: 18 N·m

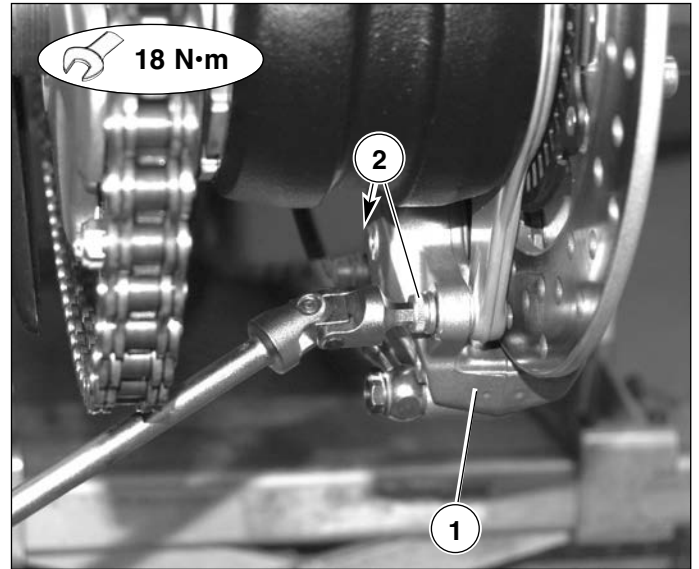

Reinsert the rubber clamp (1) around the rear brake pipe.

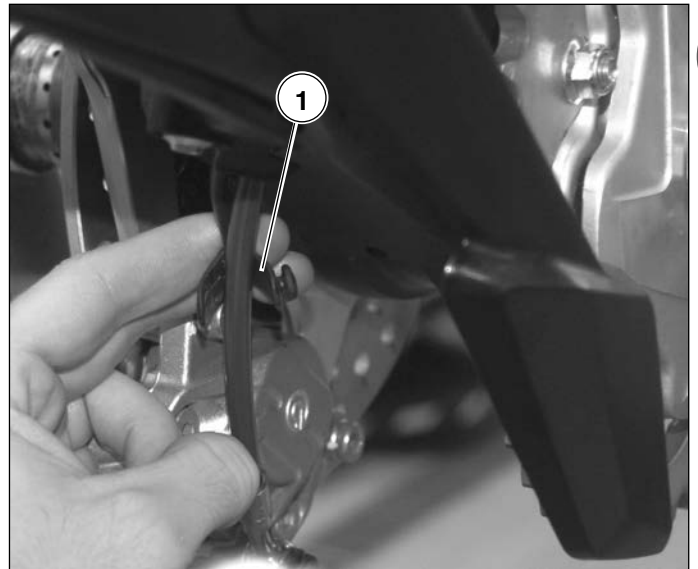

Reposition the nut of the flange (1) with the relative washer (2) without tightening.

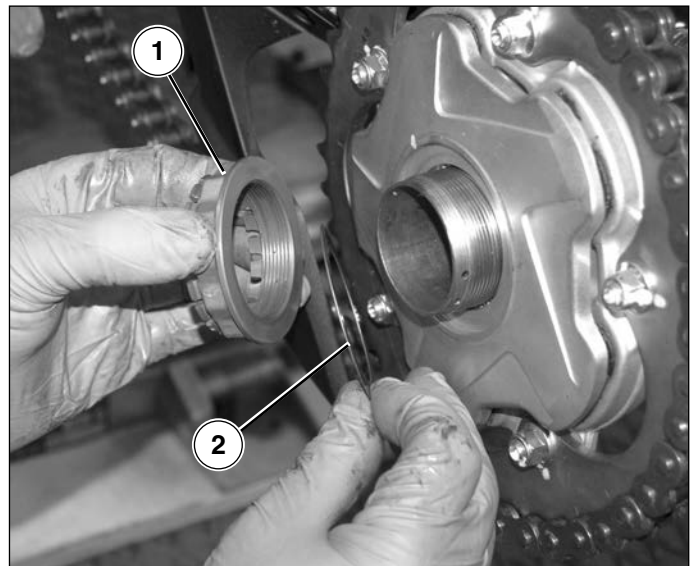

F



Suspension and wheels

Using the special spanner, bring the eccentric back into position by rotating in an anti-clockwise direction to tighten the chain.



Special tool:

Spanner for eccentric hub

Extension for spanner

N. 800092854

N. 800092855

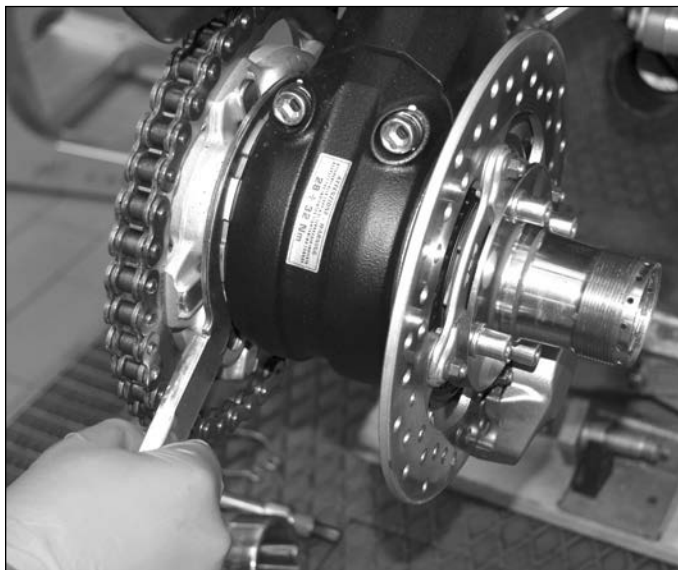

F Tighten the two fastening elements (1) of the wheel hub.



Tighten the wheel pin fixing nut by rotating it clockwise as shown in the figure, by using the following tools:



• **Torque wrench**

• **55 mm polygonal socket wrench**



Slip flange nut coupling torque:

200-220 Nm



Apply grease only on the threaded part

Assemble the retaining ring (1).

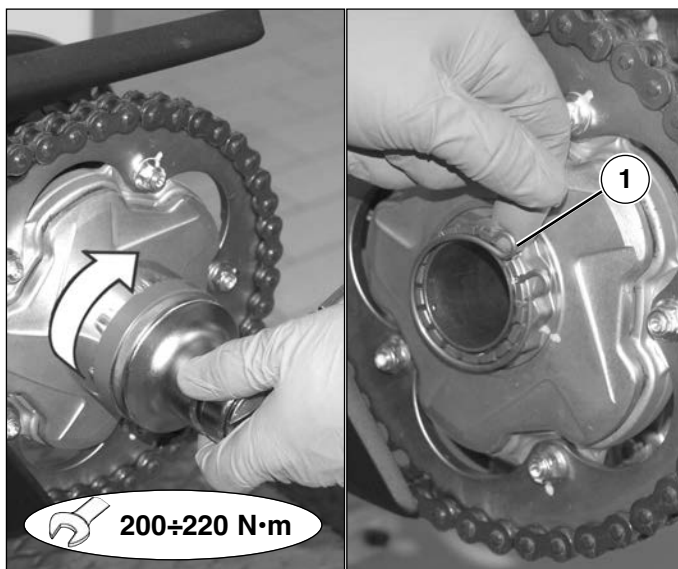

Rear wheel assembly



In the case of substitution of the rear tyre it will be necessary to effectuate the balancing of the wheel before assembling it. Follow the instructions indicated in page 81.

Insert 1st gear. Reassemble the rear wheel.
Tighten the wheel axis nut to the prescribed torque pressure.



Rear wheel RH nut torque pressure: 220 ÷ 240 N·m



Apply grease only on the threaded part

Insert the retaining ring (1).

At the end of the re-assembly procedure, restore the tension in the chain.

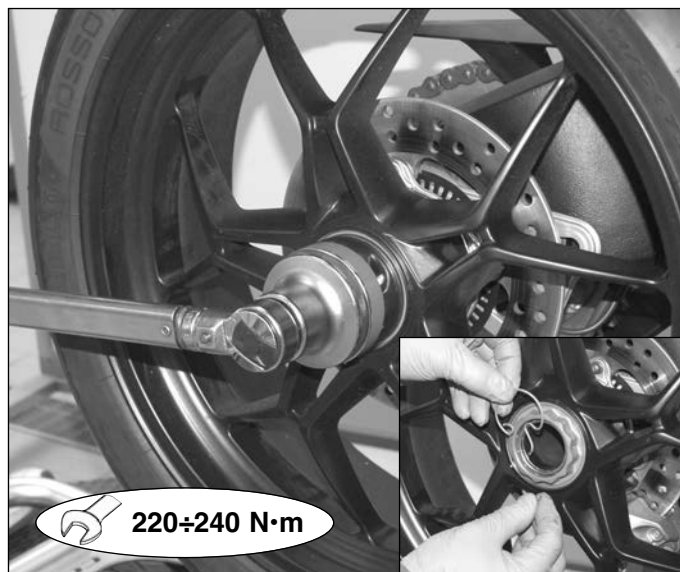

Pinion disassembly

Remove the fastening elements of the gear extension (1).

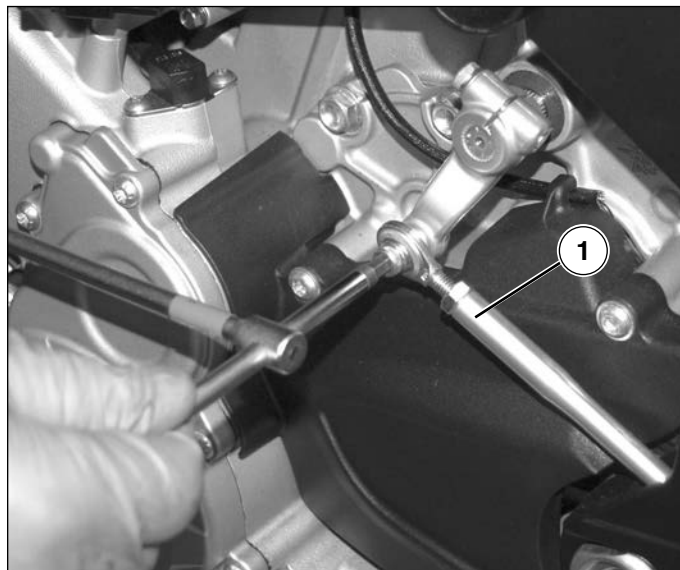

F Remove the fastening elements of the left foot peg (2).
Remove the gear extension and the foot peg to access the pinion cover.

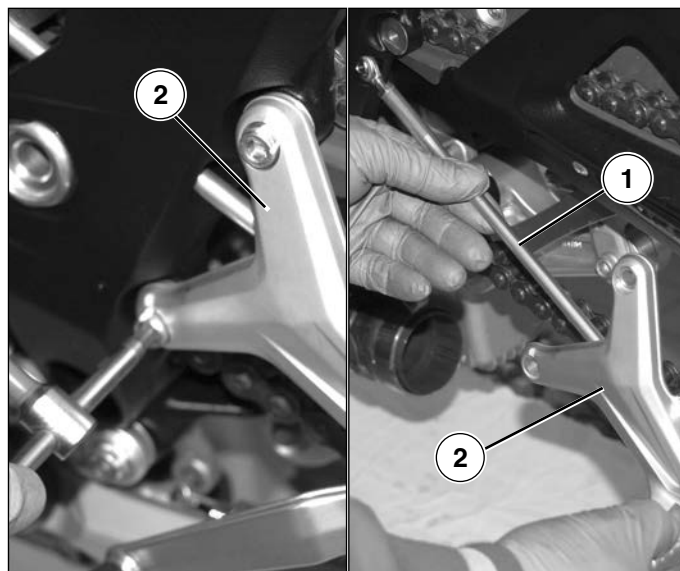

Remove the 3 clamping screws (2) and remove the pinion cover (1).

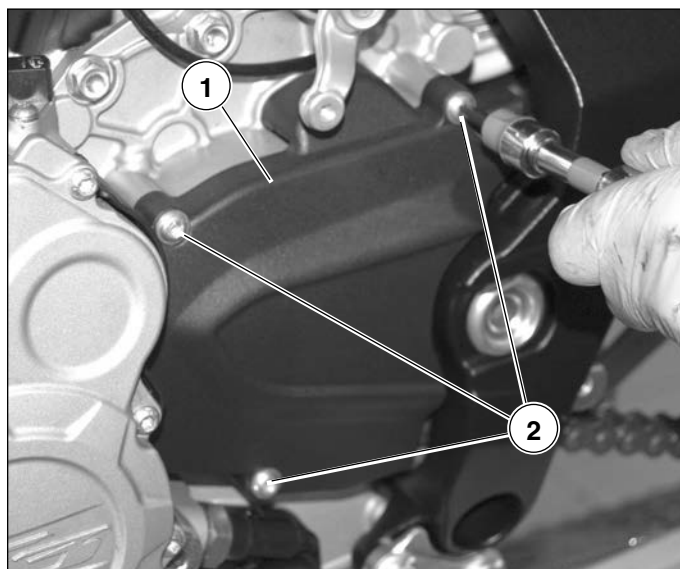



Suspension and wheels

Straighten the metal tongue with a flat-head drift and hammer.

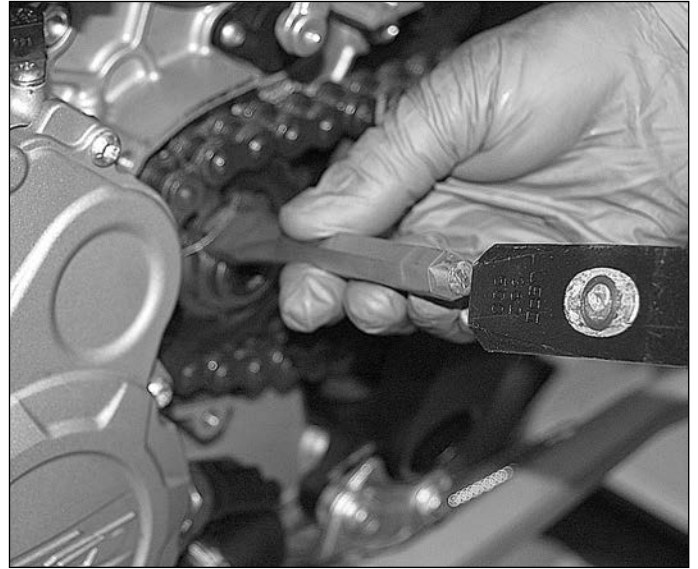

Put it in first gear by moving the lever clockwise by hand.
Heat the nut with a heat gun.



Unscrew the pinion wheel retaining nut.

Now cut and remove the chain as described on pages 53-54.

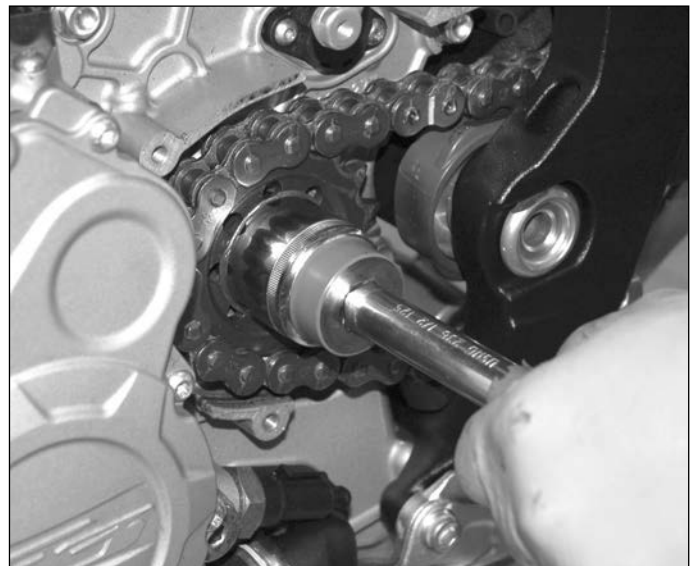



Suspension and wheels

Using the specially designed spanner, remove nut (1) and washer (2).

Remove the pinion and replace it with a new pinion.

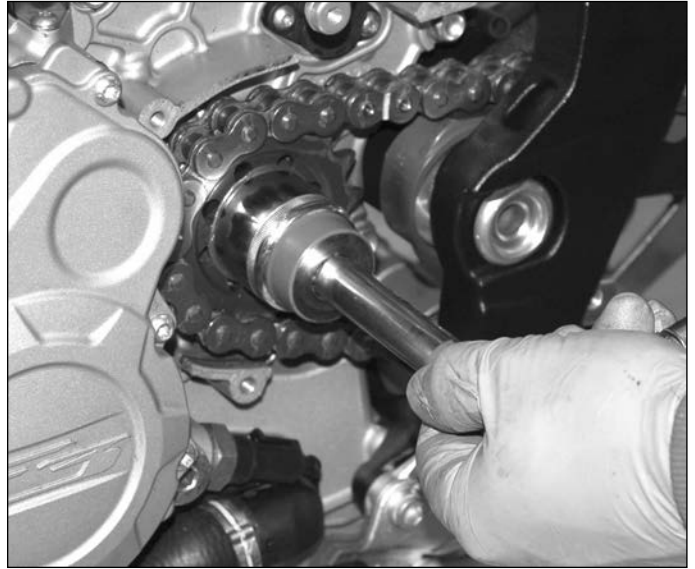

F For reassembly, insert the pinion to end stroke. Take a new washer, assemble it with the nut and tighten to the prescribed torque pressure utilising Loctite thread-locking fluid.



Torque pressure: 140 N·m



Recommended thread-locking fluid: Loctite 270

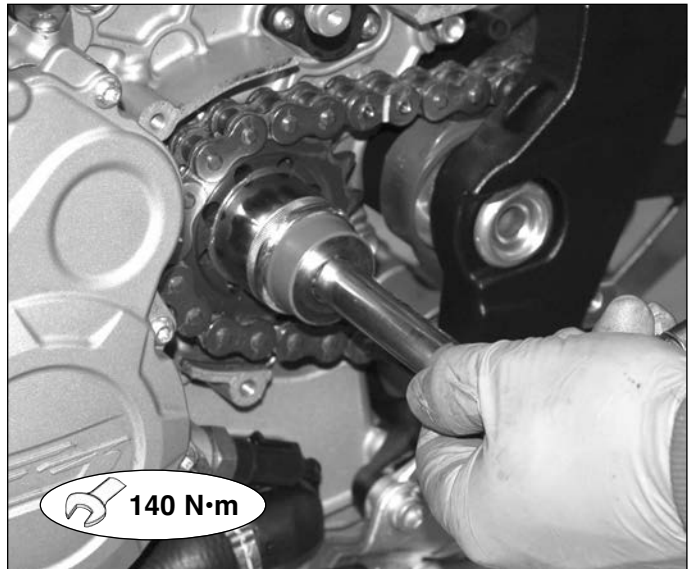

Hammer the new washer down onto the two opposite faces of the hexagon.

Remove the chain as described on pages 54-56.

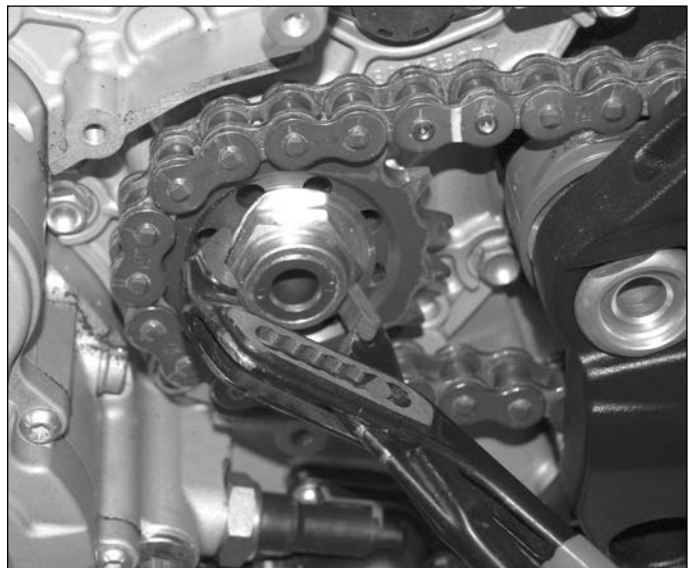



Suspension and wheels

Reassemble the pinion wheel cover after having cleaned the support base.
Proceed with the tightening, screwing down respectively on the three screws M6 (1)

 **Torque pressure (M6 Screws): 10 N·m**

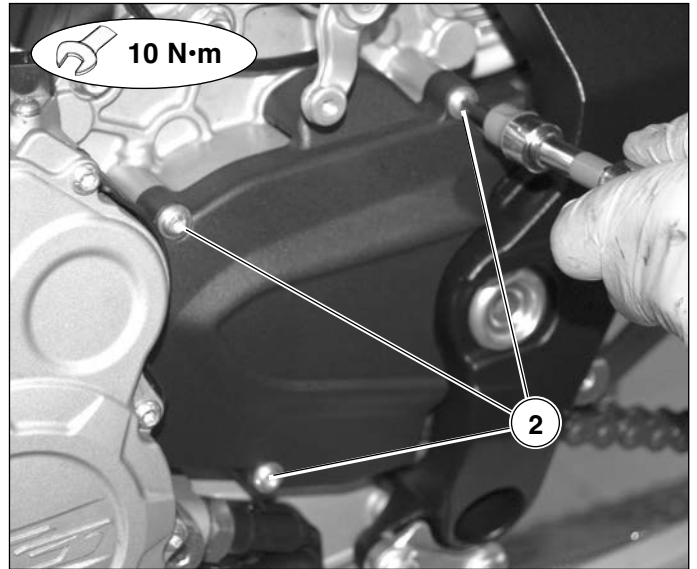

MOTORCYCLE SET-UP ADJUSTMENT

Place the motorcycle on the rear stand.

 **Special tool no. 800092642**

 **WARNING: The following adjustments must be made when the fuel tank is full.**

Insert the setting-up arm (1) of the rear suspension (special tool) in its appropriate seats as shown in the figure.

 **Special tool no. 8000B6787**

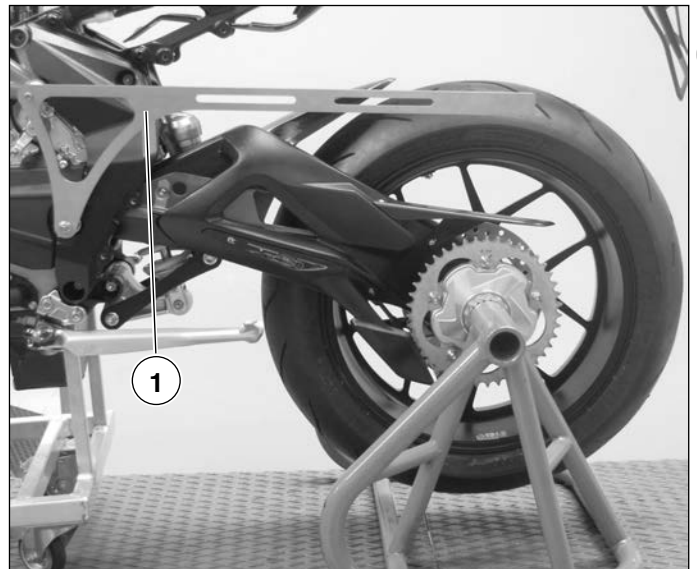

Raise the rear part of the motorcycle until the full extension of the rear shock absorber is reached. Contemporaneously measure the distance X_1 between the upper extremity of the rear stand and the point on the setting-up arm shown in the figure.

NOTE Two persons must carry out this operation.

Check that dimension X_1 is equal to:

F3 675: $X_1 = 300$ mm
F3 ORO: $X_1 = 300$ mm

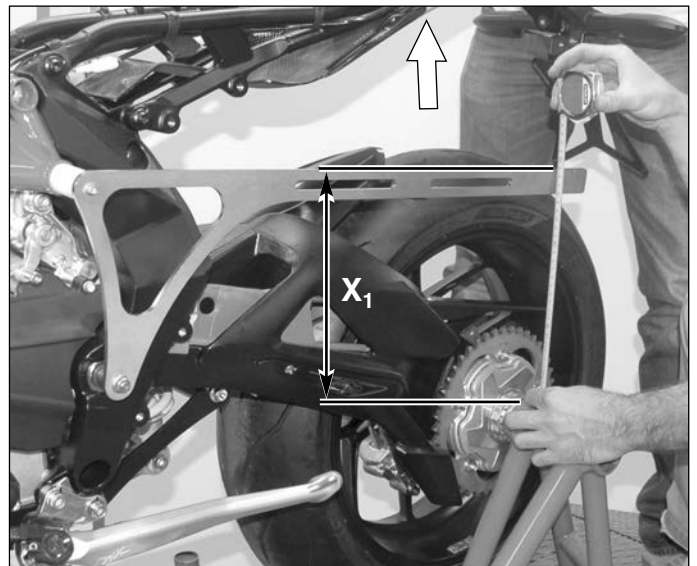



Suspension and wheels

Press down the saddle to compress the rear shock absorber, then allow the vehicle to spring back to its rest position.

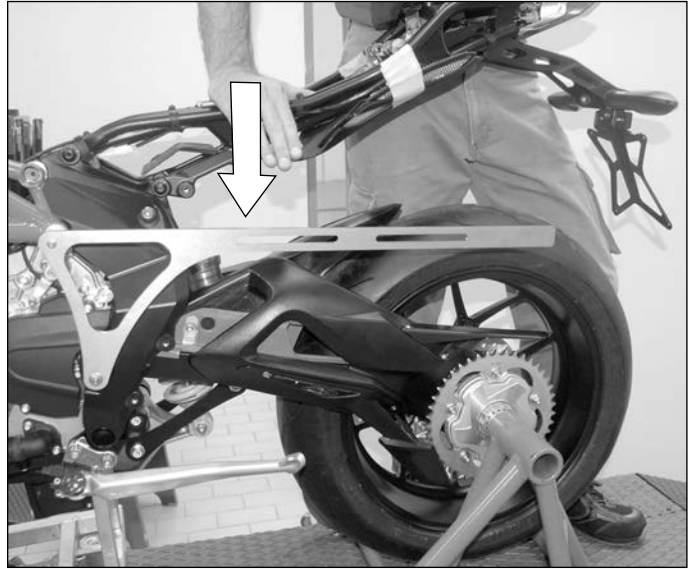

F Measure the distance X_2 between the upper end of the stand tube and the point on the setting rod indicated by an arrow (see figure).

Calculate static settling Δ using the following formula:

$$\Delta = X_1 - X_2$$

The static settling value should be:

F3 675: $\Delta = 10 \text{ mm}$

F3 ORO: $\Delta = 13 \text{ mm}$

If the value differs, act on the spring pre-load adjustment ruing nut using the required tool, in either one direction or the other depending on the calculated value of Δ static sag.

- **F3 675:**

 **Special tool no. 75 mm hook wrench**

$\Delta < 10 \text{ mm}$: Turn anticlockwise

$\Delta > 10 \text{ mm}$: Turn clockwise

- **F3 ORO:**

 **Special tool no.: Wrench n° 8000B7038**

$\Delta < 13 \text{ mm}$: Turn anticlockwise

$\Delta > 13 \text{ mm}$: Turn clockwise

After having completed the adjustment of the motorcycle set-up, it is necessary to adjust the tension of the chain.

Check also the orientation of the front headlight and if necessary effectuate the necessary adjustments.

Both these operations are described in chapter B "Maintenance".

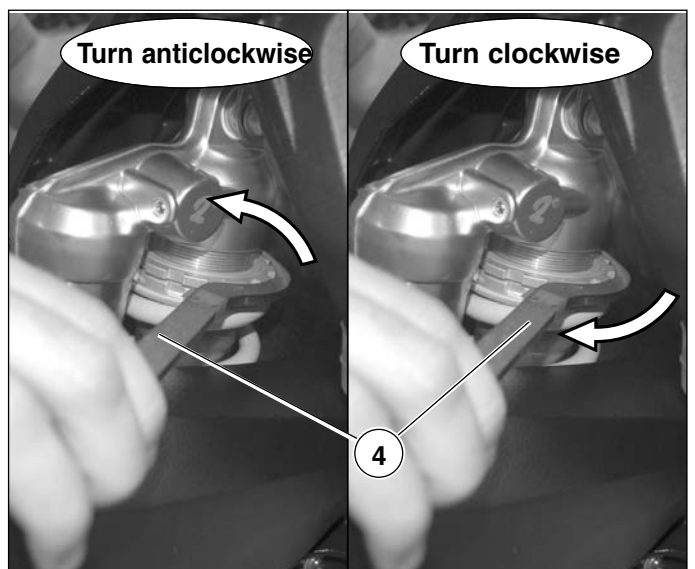
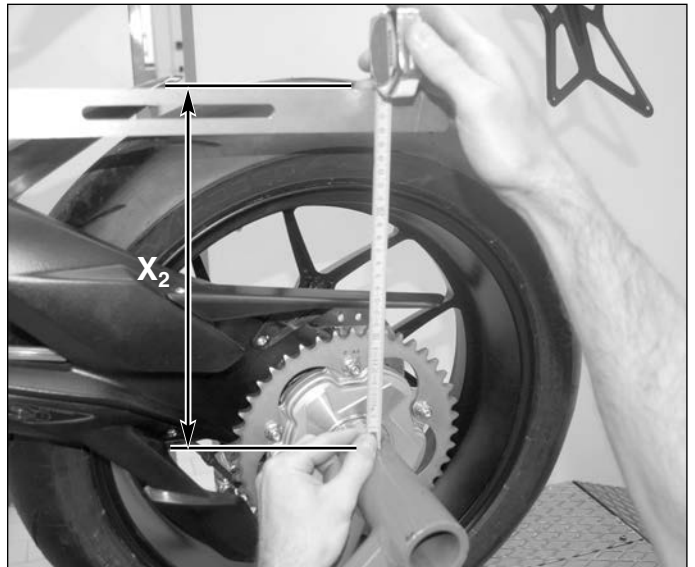

WHEEL BALANCE CHECK

If the tyres are substituted, it is necessary to effectuate the following operations balancing and checking the wheels.

Front wheel balancing

Mount the wheel onto an adequate support similar to that shown in the figure, utilising a ground pin of **35 mm** diameter. Check the wheel. Utilising a dial gauge, check the following tolerances:



Ovalization and maximum eccentricity must not exceed **0.5 mm**.
Flatness must not exceed **0.5 mm**.

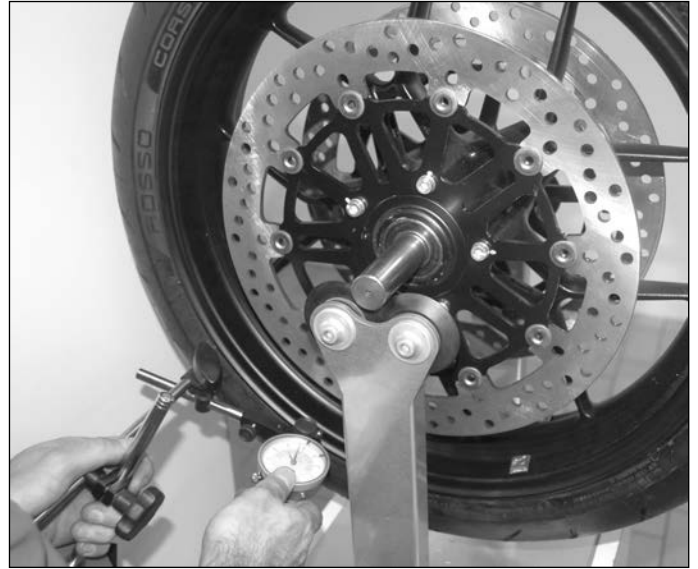

 **When effectuating balancing on certain makes of tyres, it is necessary to refer to the yellow mark (1) present on the side of the tyre as shown in the figure. It indicates the lightest point of balancing and must be situated close to the tyre valve when the tyre is mounted onto the wheel rim.**

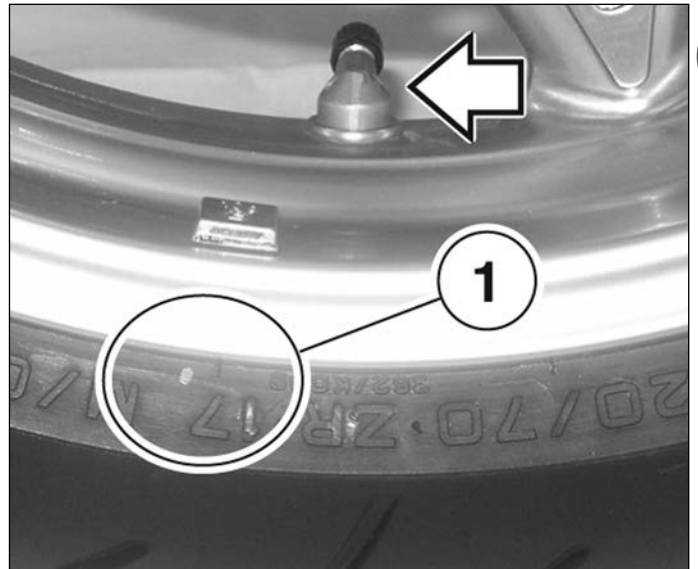

F

Rear wheel balancing

Before mounting the rear wheel on the appropriate tool, insert the balancing tool into the central hole of the wheel.



Special tool N. 800092865





Suspension and wheels

Insert the polygonal nut of the balancing tool from the opposite side and screw it onto the threaded part of the tool so that the tool can be fixed to the wheel.



F Mount the wheel onto an adequate support similar to that shown in the figure, utilising the special tool cod. **8000A1953**. Check the wheel utilising a micrometer gauge and check the following tolerances:



Ovalization and maximum eccentricity must not exceed **0,5 mm**.



Special tool N. 8000A1953



Place the dial gauge as shown in the figure, and check the flatness.



Flatness must not exceed: 0.5 mm.

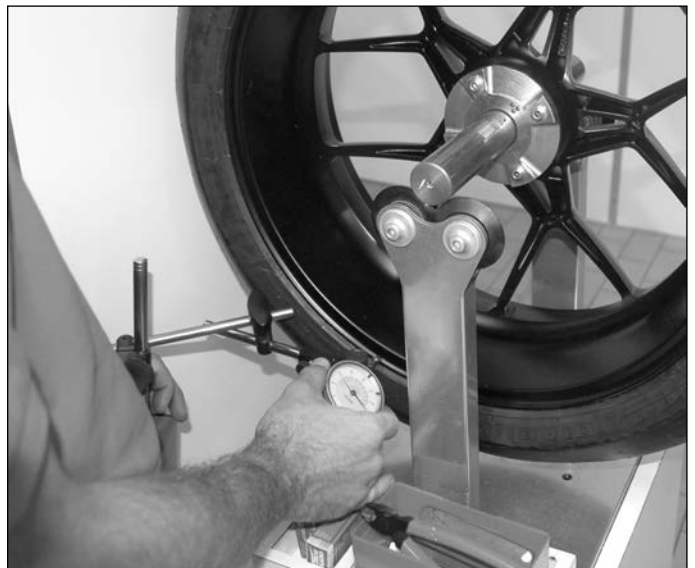



When effectuating balancing on certain makes of tyres, it is necessary to refer to the yellow mark (1) present on the side of the tyre as shown in the figure. It indicates the lightest point of balancing and must be situated close to the tyre valve when the tyre is mounted onto the wheel rim.

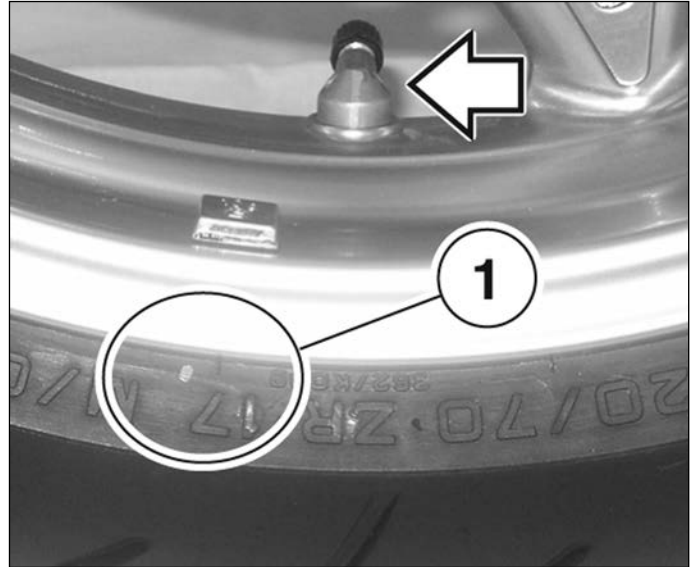



Suspension and wheels

F



Frame

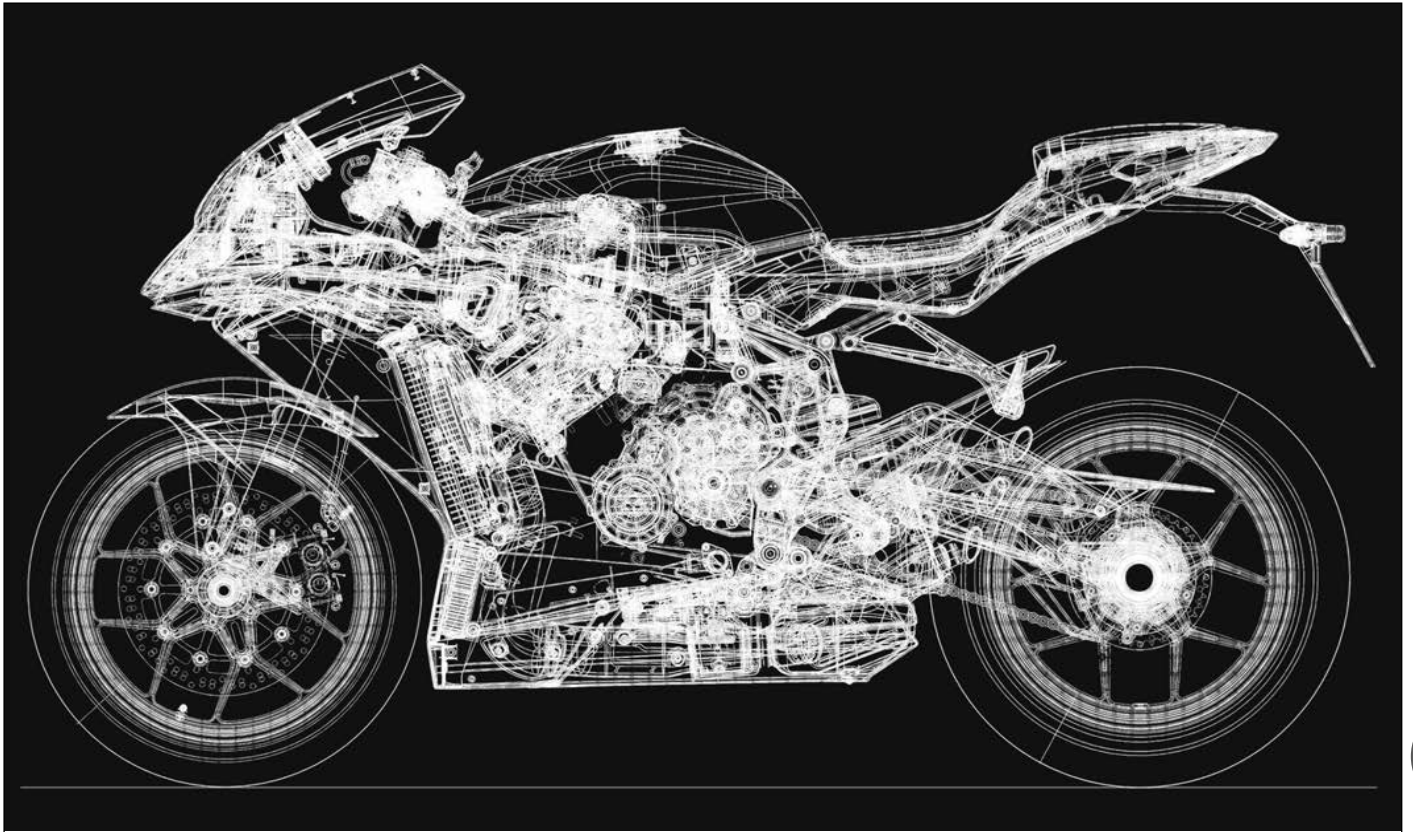

G

SECTION G
Revision 0



Frame

SUMMARY

BATTERY CABLES	PAGE 3
SIDE STAND REMOVAL	PAGE 6
FOOT PEG REMOVAL	PAGE 8
EXHAUST SILENCER DISASSEMBLY	PAGE 9
EXHAUST TUBES REMOVAL	PAGE 10
FRAME REMOVAL PRELIMINARY OPERATIONS	PAGE 12
THROTTLE BODY REMOVAL	PAGE 13
PLUG-TOP COIL DISASSEMBLY	PAGE 16
REMOVING THE BATTERY BOX	PAGE 18
REMOVING THE SOLENOID STARTER	PAGE 19
REMOVING THE MAIN CABLING	PAGE 20
REMOVING THE PASSENGER SEAT LOCK	PAGE 23
REMOVING THE FUSE PANEL MOUNTING PLATE	PAGE 23
REMOVING CLUTCH CONTROL TRANSMISSION	PAGE 24
REMOVING THE FRONT COWL MOUNTING FRAME	PAGE 25
FRAME DISASSEMBLY	PAGE 25
FRAME CHECKS AND INSPECTION	PAGE 27
STEERING BEARINGS HOUSING CHECK	PAGE 30
FRAME ASSEMBLY ON THE VEHICLE	PAGE 31
REAR FRAME DISASSEMBLY	PAGE 35
FRAME PLATE REMOVAL	PAGE 36
RE-ASSEMBLY OF THE VEHICLE	PAGE 41
REAR FRAME UNIT ASSEMBLY	PAGE 41
EXHAUST VALVE TRANSMISSIONS ASSEMBLY AND ADJUSTMENT	PAGE 42



BATTERY CABLES

 It is a good rule to disconnect the battery cables before removing components from the motorcycle.

Remove the cowl and tank as described in chapter C "Bodywork".

Remove the screw (1) indicated in the figure
Disconnect the negative pole of the battery.

 When removing the battery, it is necessary to remove the negative pole cable first and then the positive pole cable. When reassembling, proceed in the reverse order.

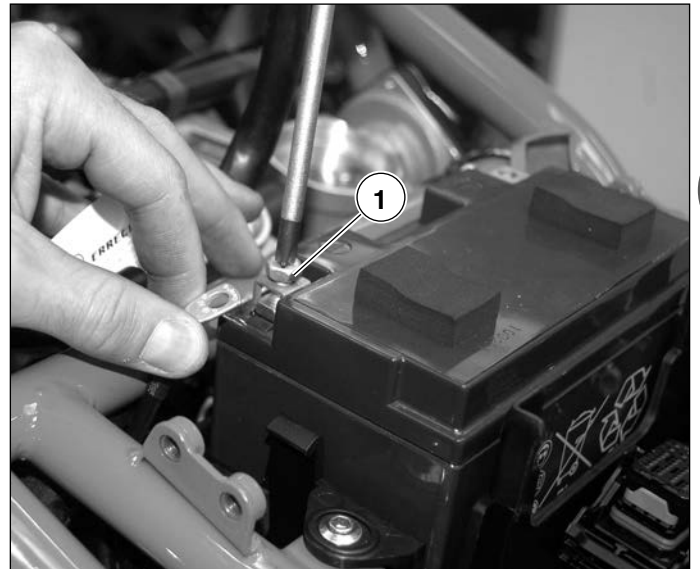

Disconnect the positive pole of the battery.

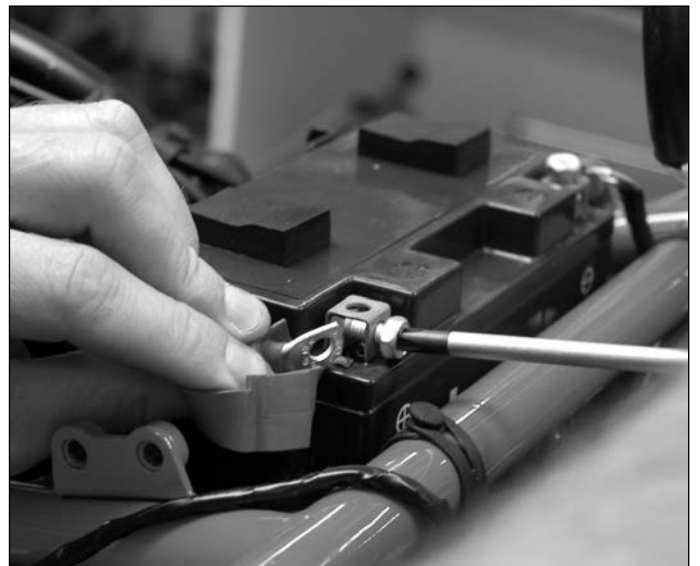



Frame

Remove the battery from its compartment.

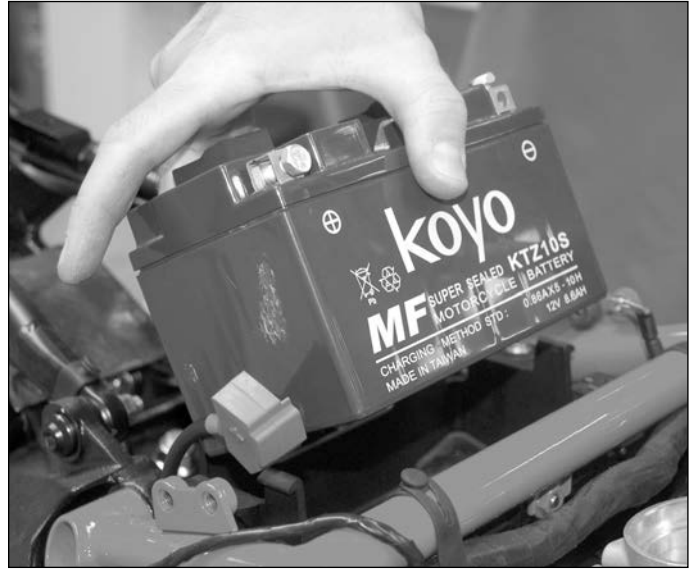

Remove the battery mounting by unscrewing the 3 screws.



Remove the 4 Relais (2 per side).





Frame

If it is necessary to remove the engine power and earth cables, once the battery has been removed as described above, remove the screws as shown in the figure.

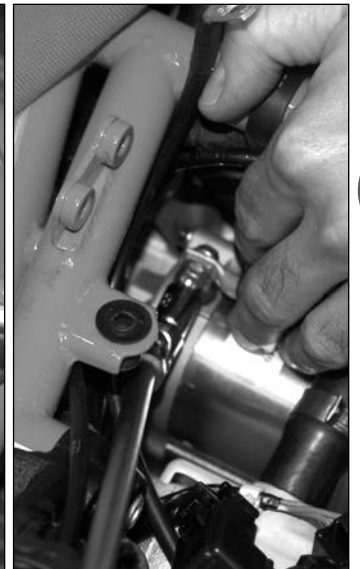

G



Frame

SIDE STAND REMOVAL

If the side stand needs to be replaced, use the following procedure:
Place the motorcycle on the rear stand (special tool).

 **Special tool No. 800092642**

Remove the side fairings and the underfairing as described in the chapter "Superstructures."

Disconnect the electrical connector of the safety switch(1).

Remove the side stand safety switch by unscrewing the screws (2) indicated in the figure.

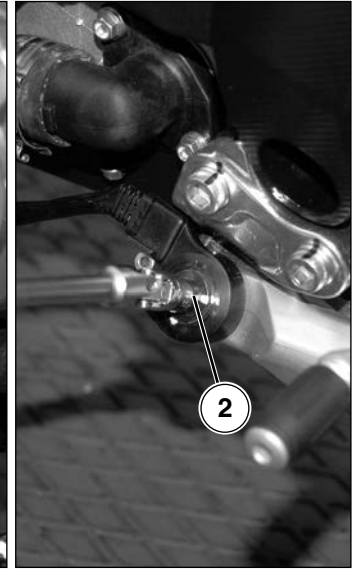
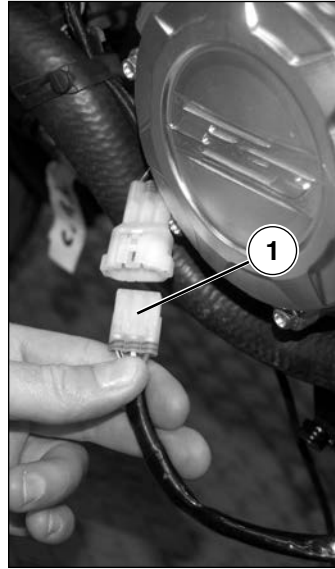

Release the two springs (3).

Remove the nut (4) located behind the stand mount.

Remove the screw (5).

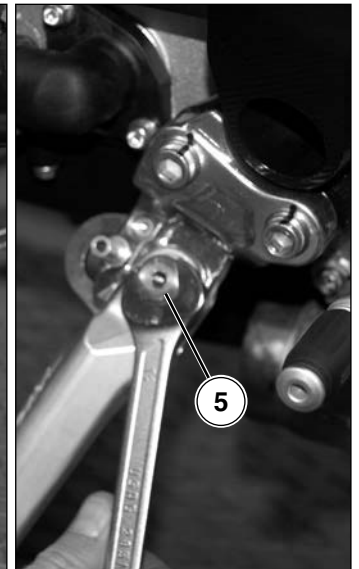
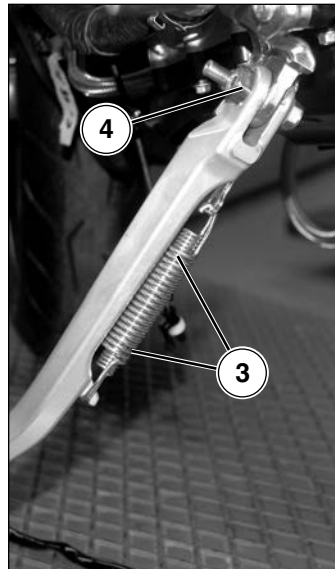

If the stand plate needs to be removed, remove the 2 fixing screws (6).

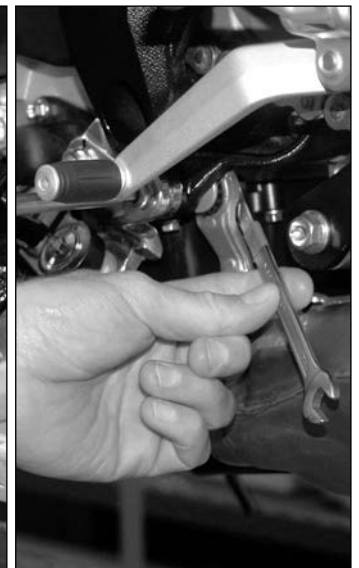
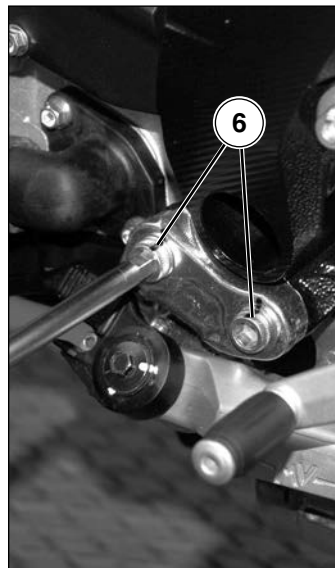



Frame

For reassembly, proceed in the reverse order of removal.

Apply the recommended thread-locking liquid to the 2 plate fixing screws.

Tighten to the prescribed torque pressure.

 **Tightening torque for the stand plate screws (6):**
 $40 \div 44 \text{ N}\cdot\text{m}$

 **Recommended thread-locking liquid: Loctite**
243



 **Side stand switch screw tightening torque**
(2): $8 \div 10 \text{ N}\cdot\text{m}$

 **Recommended thread-locking liquid: Loctite**
243

 **The springs must be removed with a specially designed tool.**

Before reattaching the springs, ensure that the stand can swing freely (with no friction or sticking).



G



Frame

FOOT PEG REMOVAL

Before disassembling the left foot peg remove the clamping screw (1) from the gear extension.

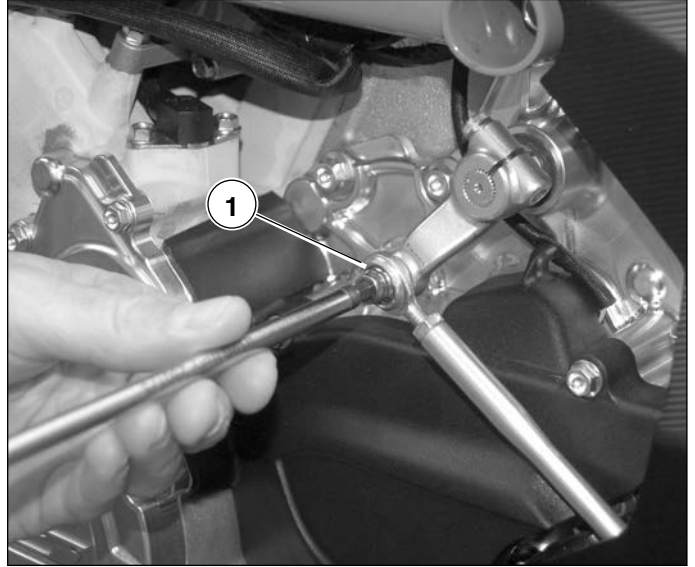

On the right foot peg, also remove the silencer clamping screw (2).

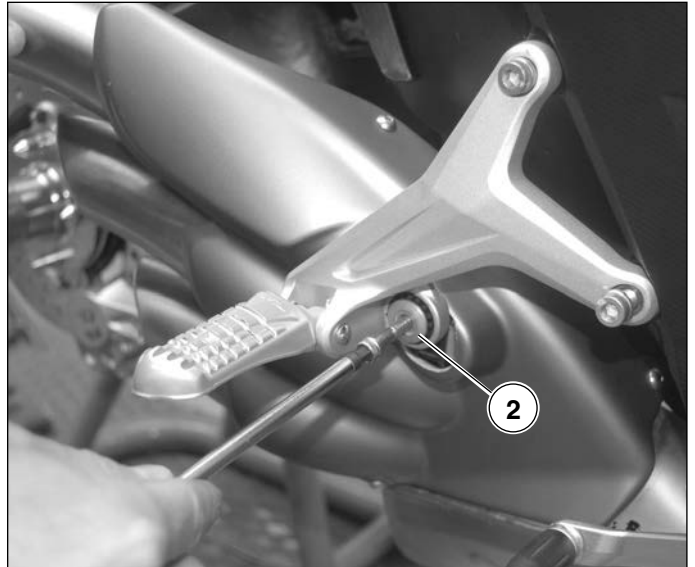

Act on the 2 screws (1) of both foot peg mountings and remove them.

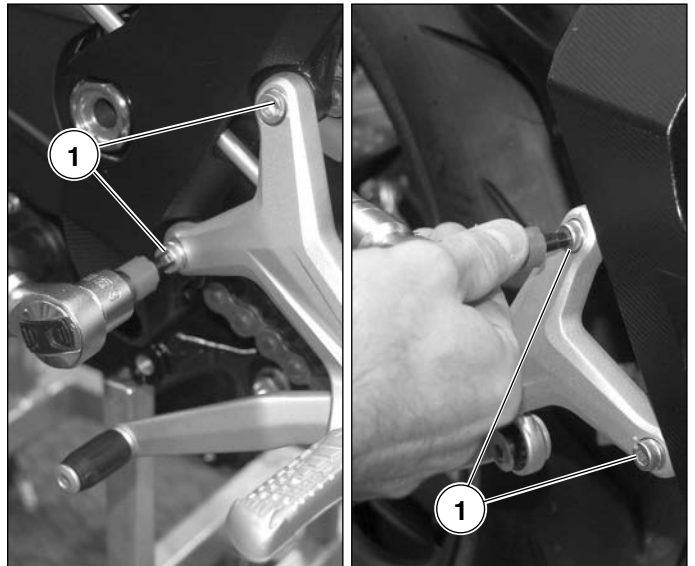



EXHAUST SILENCER DISASSEMBLY

Remove the clamping screw on the lh side.



Remove the socket head screw on the right side holding the nut still with a 10mm wrench.



Pull the silencer unit out from the exhausts.

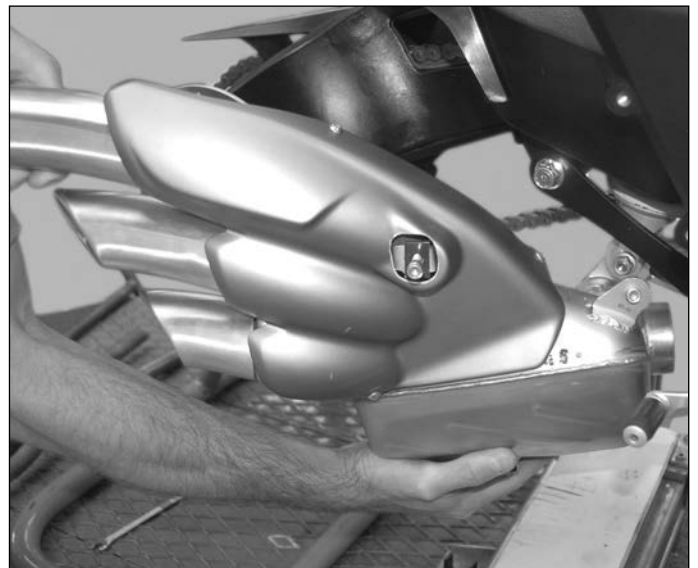

G



EXHAUST TUBE REMOVAL

NOTE: This operation is not necessary for disassembly of the engine or frame. Proceed as described below for exhaust manifold replacement.

Disassemble the water radiator and oil radiator beforehand, as described in chapter L "Cooling system".

Slide off the Lambda probe connector (1) and lift.

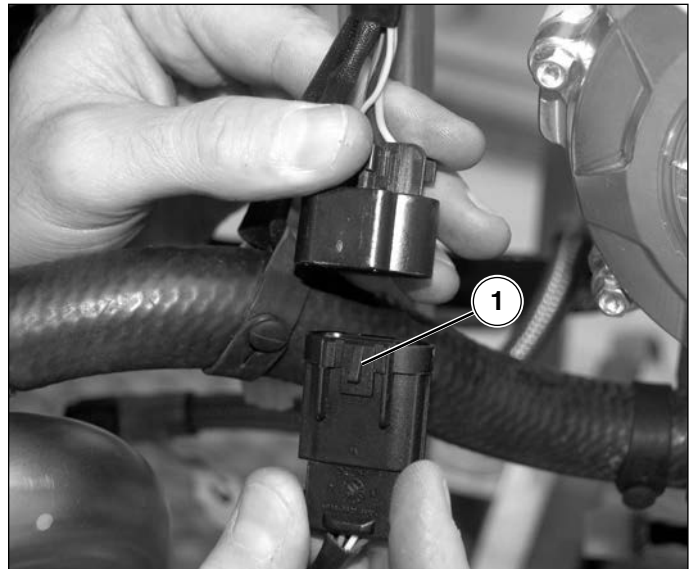

Unscrew the 6 nuts (2) relative to the manifold (set of the three tubes).

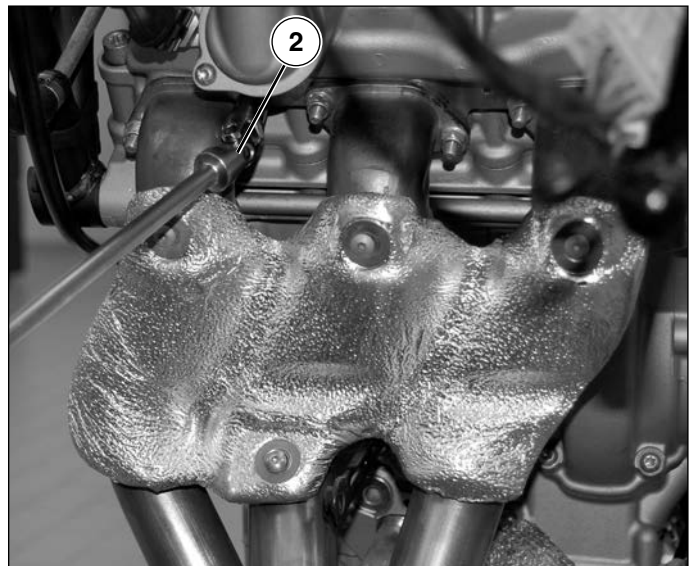



Frame

Remove the manifold as indicated in the figure.

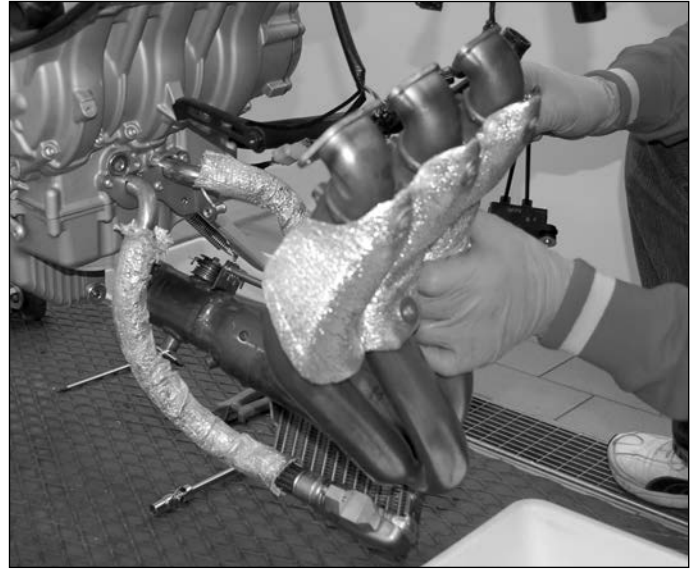

Disassemble the metal sealing gasket (3) in the head.

Apply sufficiently adequate wadding to the exhaust ports to stop the entry of dirt and dust into the cylinders.



If the engine has to be removed from the frame, it will be necessary to remove the chain as described in chapter F "Suspension and wheels".

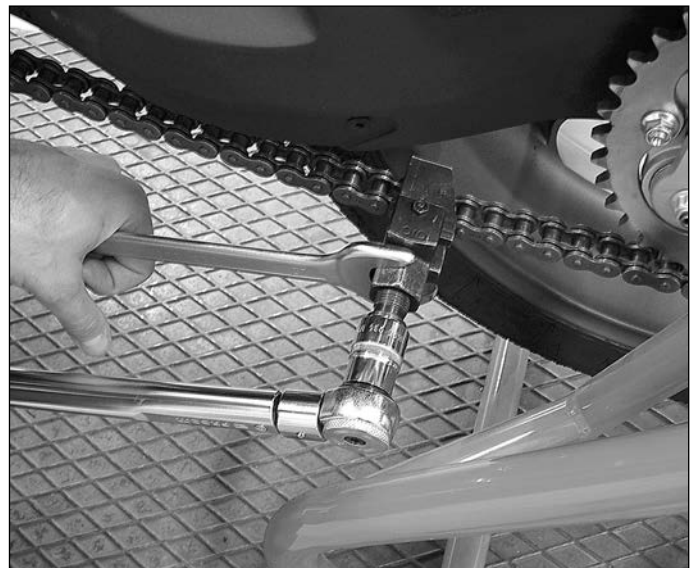



Frame

FRAME REMOVAL PRELIMINARY OPERATIONS

Support the motorcycle with the aid of the following stands:

- Cod. 800092642: Rear stand
- Cod. 800095807: Front stand
- Cod. 8000B7340: Front stand pin
- Cod. 8000B6789: Engine support



Remove the following components in order:

- Front mudguard
- Front brake callipers
- Front wheel
- Central air manifold

as described in chapters F - "Suspension and Wheels" and C "Bodywork".

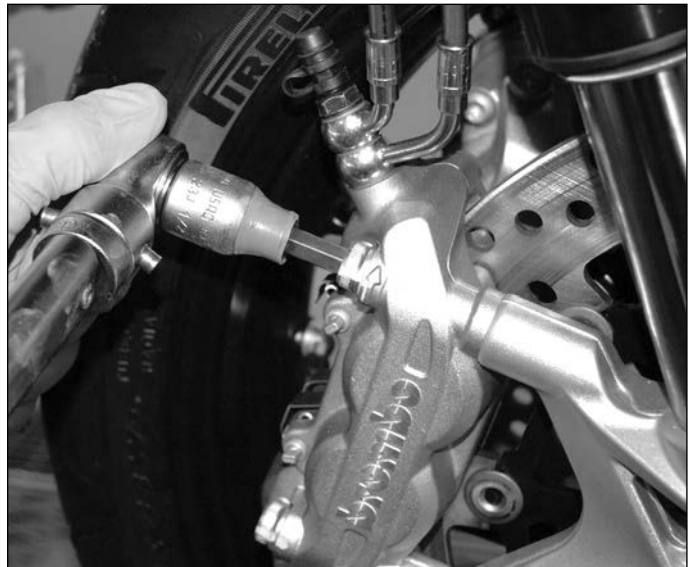



THROTTLE BODY REMOVAL

Remove the 2 cable-retaining clamps (1).



Remove the pressure sensor (2).



Disconnect the 3 injector connectors (3).





Frame

Disconnect the 6 clamping screws (4) of the throttle body.

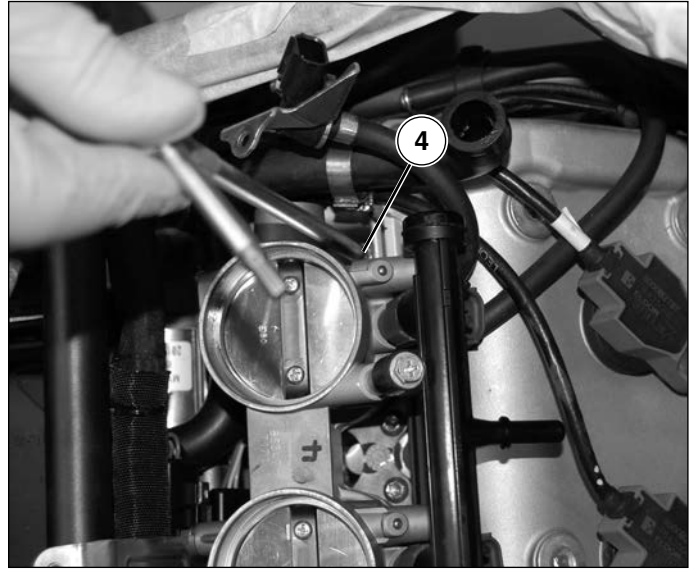

Lift the throttle body as shown in the figure.



Disconnect the DBW control connection (5).





Frame

Protect the air intake lines using adhesive tape in order to avoid dirt from getting into the cylinders.



Re-assemble following the disassembly instructions in reverse order.

Remove the following components in order:

- Steering head
- Acoustic warning signal
- Right/left handlebars
- Right/left front forks
- Steering base

as described in chapter F - "Suspension and Wheels."



Frame

PLUG-TOP COIL DISASSEMBLY

Remove the 3 screws (1) and the clamping bracket (2) for the plug-top coils.

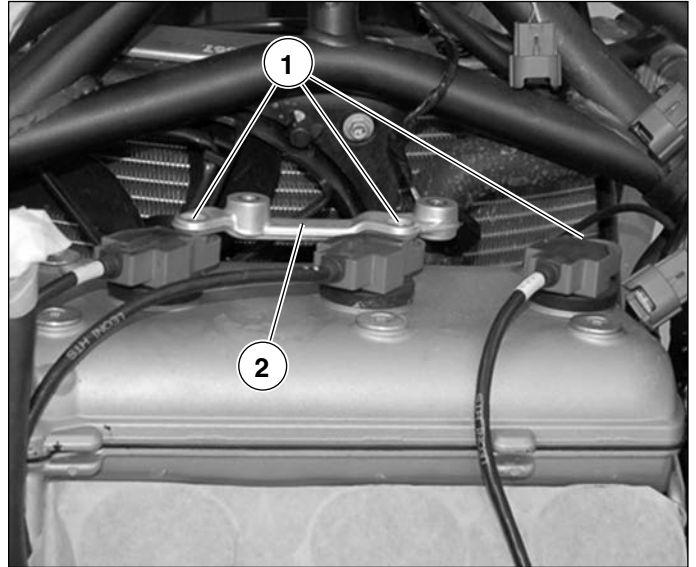

Take the 3 plug-top coils out, as shown in the figure.



Remove the 2 clamping screws from the connector located on the flange of the throttle body.





Frame

Disconnect the electrical connections as shown in the figure.

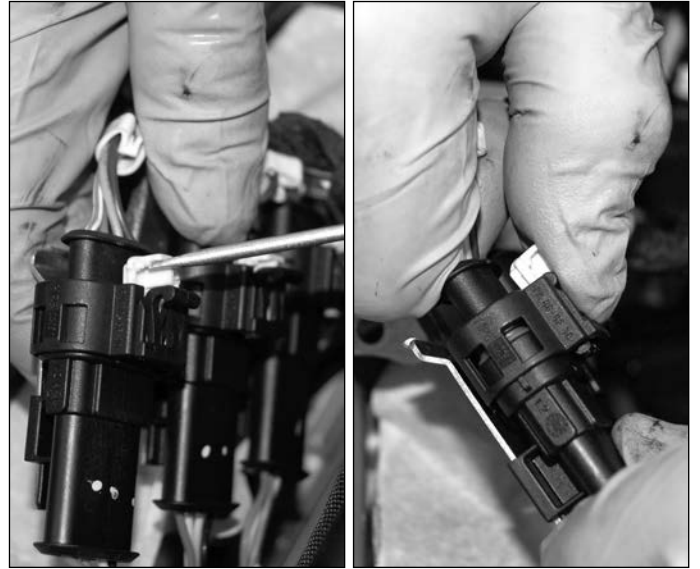

Slide the electrical connections out.



Take the reel unit off.



G



Frame

REMOVING THE BATTERY BOX

Remove the entire ECU.



Remove the 3 screws (2) that clamp the battery box to the frame.



Disconnect the 4 relais (2 per side).





Frame

Take off the battery box.



REMOVING THE SOLENOID STARTER

Disconnect the connection to the starter motor.



Disconnect the connector of the main system.





Frame

Remove the clamping screw for the remote switch mounting plate.



Remove the solenoid starter, including its cables.

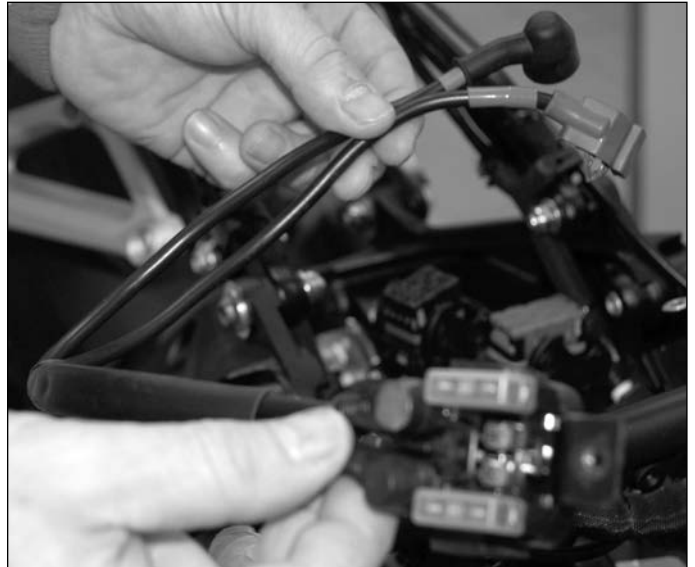

REMOVING THE MAIN CABLING

To remove the main cabling it is necessary to disconnect all of the connections and remove the clamps.

Free up the connection for the direction indicators.





Frame

Remove the fuse panel.



Remove the engine rpm pick-up.



Remove the current generator connection.





Frame

Remove the gear position sensor.



Remove the engine coolant temperature sensor.



Remove the rear wheel speed sensor.





Frame

Position all of the cabling over the rear frame.

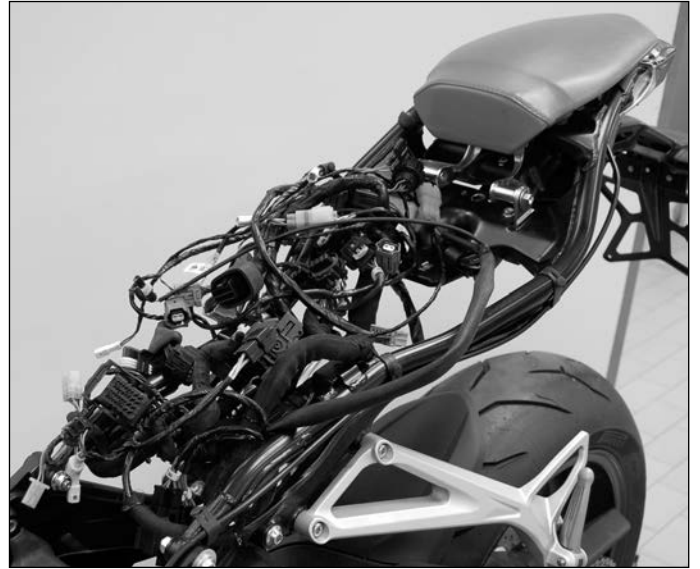

REMOVING THE PASSENGER SEAT LOCK

Remove the 2 nuts that clamp the lock to the frame



REMOVING THE FUSE PANEL MOUNTING PLATE

Remove the screw that clamps the fuse panel mounting plate to the frame.





Frame

REMOVING CLUTCH CONTROL TRANSMISSION

Loosen the nut on the clutch cable.

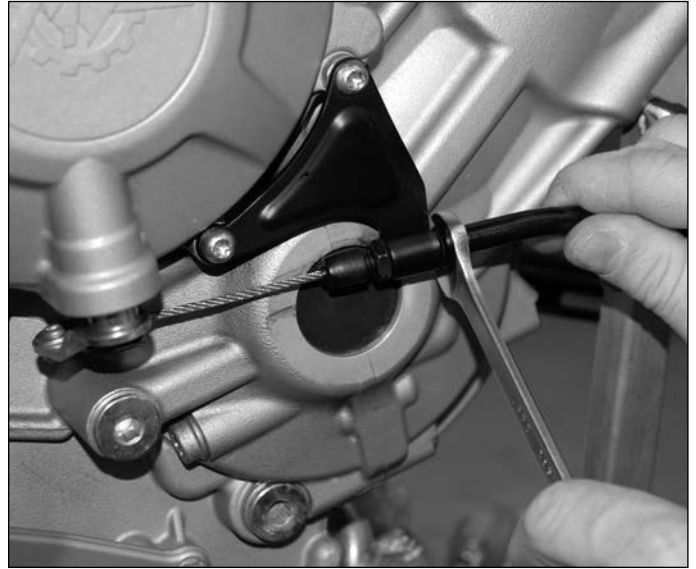

Unhook the transmission from the lever.



Unscrew the counter-nut to free up the transmission from the plate.





Frame

REMOVING THE FRONT COWL MOUNTING FRAME

Remove the 2 screws that clamp the cowl mounting frame to the frame.



Remove the front cowl mounting frame.



FRAME DISASSEMBLY

Unscrew and remove the right side front fixing nut. Remove the spindle from the left side of the frame.





Frame

Unscrew and remove the upper rear fixing screws from both sides of the frame.



Unscrew and remove the engine fixing nut from the right side of the frame.



Take the engine clamping pin out from the lh side of the frame.





Frame

Supporting the front part of the frame, shift it towards the front.

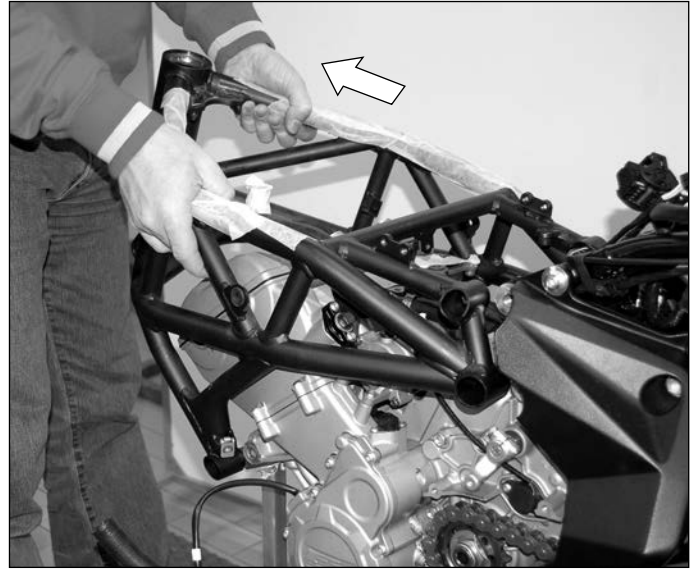

Remove the frame from the engine by lifting.



FRAME CHECKS AND INSPECTION

Clean thoroughly and check the housings of the steering bearings.





Frame

Make sure that none of the surfaces of the housings have signs of impact or dents.



Using a bore meter, check circularity of the housing of the bearing in the marked cylindrical area.



Check that there are no dents or evident breakage on frame tubes.

Replace frame if any damage is detected.

In this case, remove the following components:
- Rubber elements and springs





Frame

Steering bearings housing check

Check the diameter and for any ovalisation on the steering bearings as shown in the drawing here to the side.

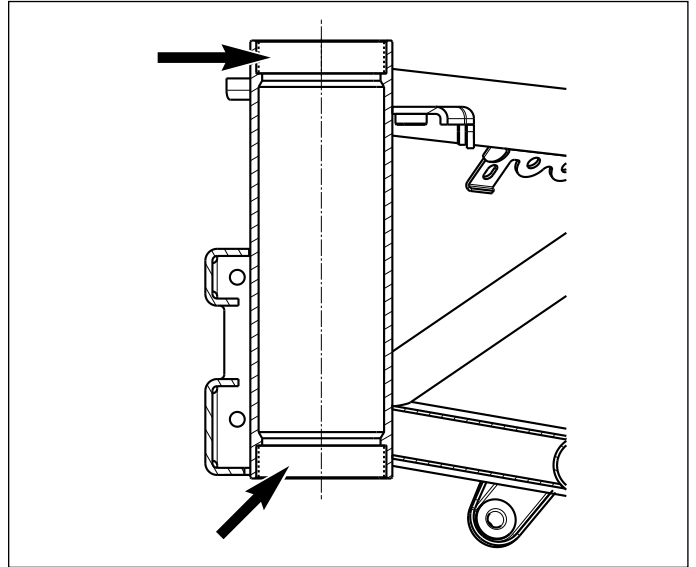

Measure ovalisation in different points as shown in the diagram.

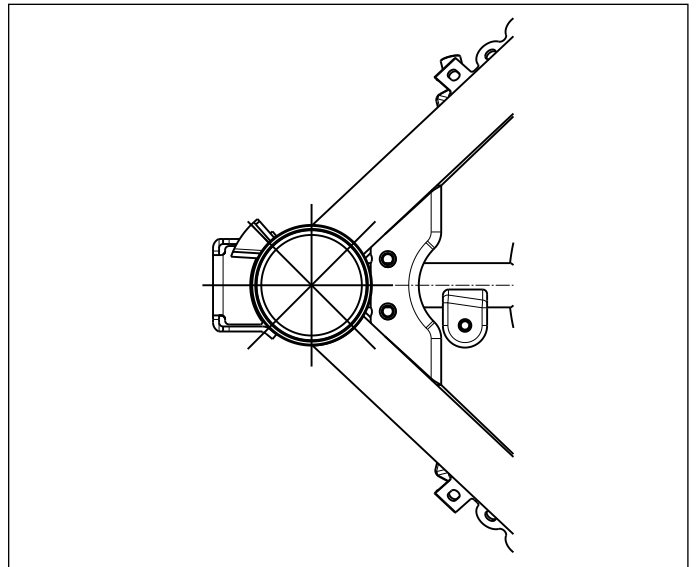



Frame

FRAME ASSEMBLY ON THE VEHICLE

If frame replacement should be necessary, you can recover components from the old frame, in particular the fairing attachment plates and threaded caps. These components can be assembled on the new frame after having carried out a careful inspection.

Contact MV AGUSTA spare parts service for approval punching and decals on the new frame.



Carefully clean the frame-engine head and frame- rear suspension plates coupling planes.



G



Frame



Once the frame has been re-installed, re-install the electrical cabling.

See Chapt. E - Electrical System regarding the positioning and passage of cables, clamps and wiring.

G



Frame

Carry out the sequence of operations of assembly in reverse order to removal for the correct assembly of the frame to the motorcycle.

Tighten the various fixings to the torque pressure shown in the following diagram.

PART.	DESIGN NO.	DESCRIPTION	DIM. N·m	TORQUE PRESSURE	
				Kgm	
①	8B00B5645	Lower frame-engine fixing screw	M12x1,25	55/60	5,5/6,0
②	8A00B5645	Lower plates-engine fixing screw	M12x1,25	55/60	5,5/6,0
③	8000B5645	Rocker arm pin screw	M12x1,25	55/60	5,5/6,0
④	8B00B2715	Front frame-engine fixing screw	M12x1,25	55/60	5,5/6,0
⑤	8000B2750	Upper frame-engine fixing screw	M12x1,25	55/60	5,5/6,0
⑥	8A00B2755	Plates fixing screw	M10x1,25	45/50	4,5/5,0
⑦	8000B2751	Rear fork pin screw	M15x1,25	70/75	7,0/7,5
⑧	8000B5650	Plate – upper sub-frame fixing screw	M8x1,25	24/28	2,4/2,8
⑨	8000B5650	Plate – lower sub-frame fixing screw	M8x1,25	24/28	2,4/2,8

The tightening of the engine mounting screws and the plates ① ② ③ ④ ⑤ ⑥ is effectuated with the motorcycle resting on its wheels and the engine hanging from the frame.

The tightening of the rear sub-frame screws ⑦ ⑧ is carried out by letting the sub-frame drop into position by its own weight.

Utilise AGIP GREASE 30 for the screws.



Frame

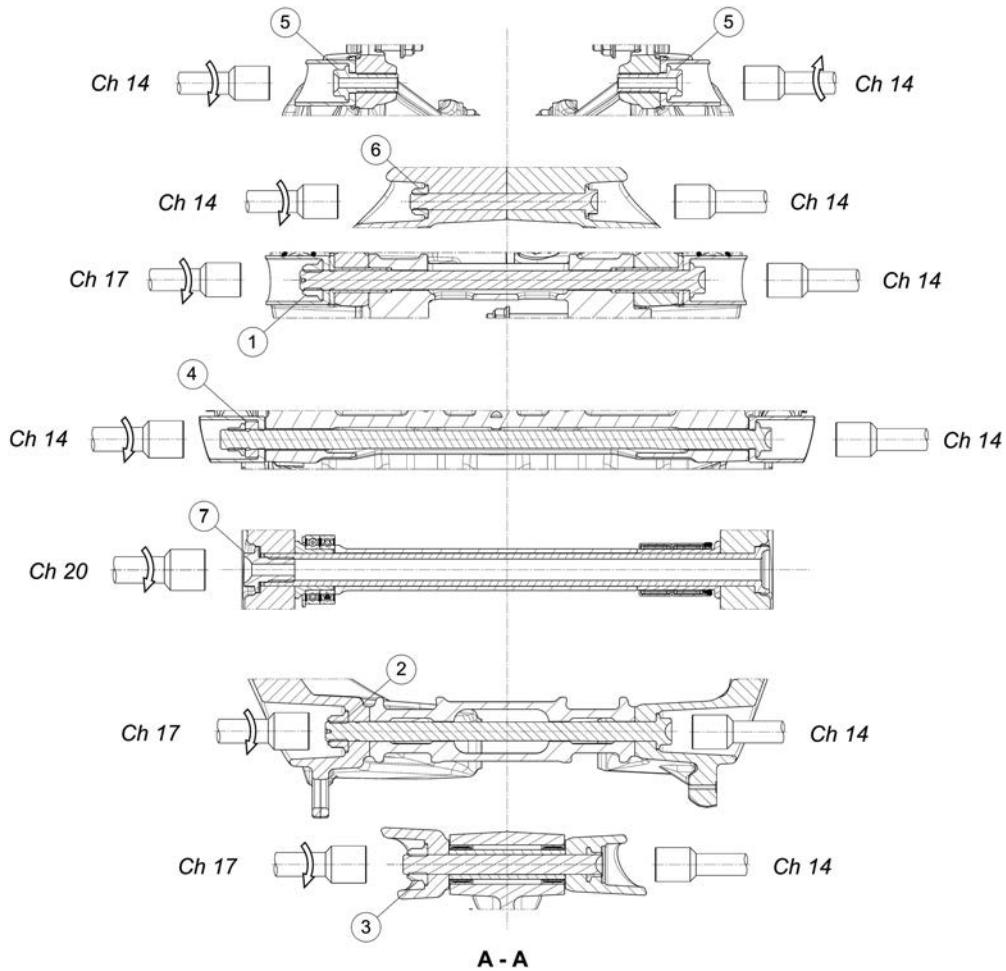
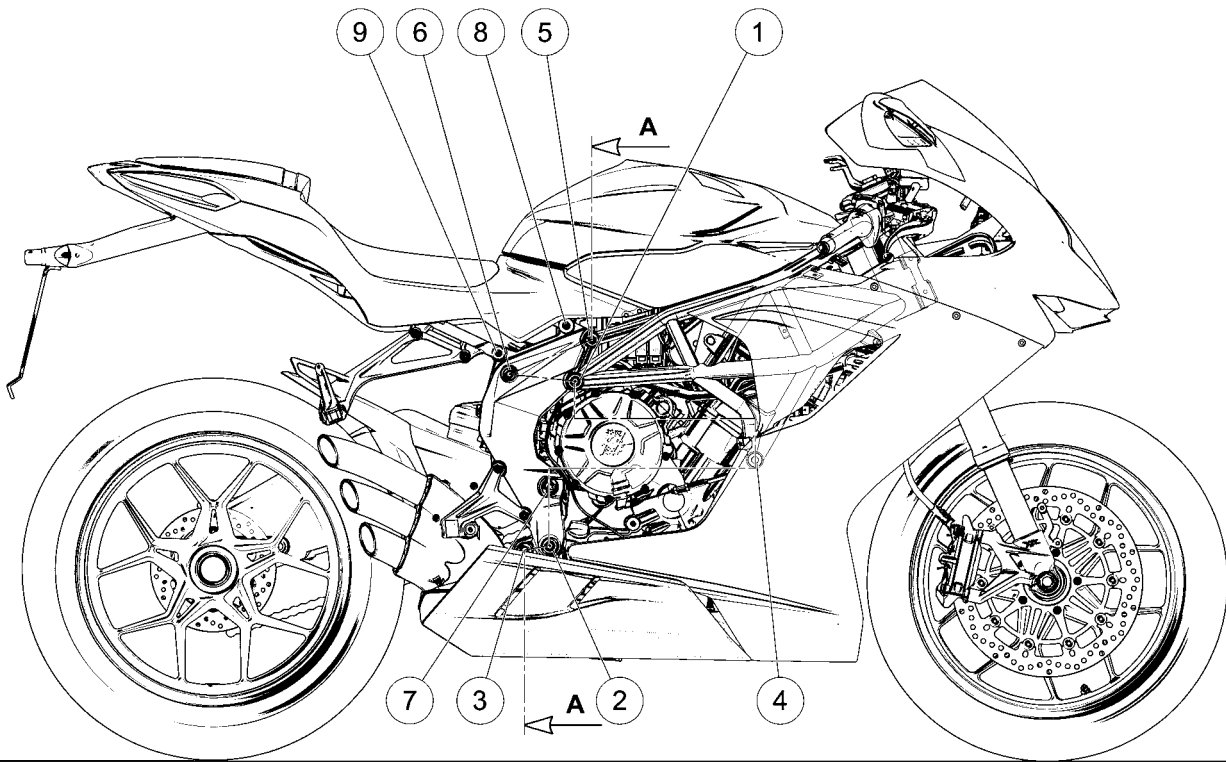



Frame

REAR FRAME DISASSEMBLY

If it is necessary to disassemble only the rear frame from the motorcycle, it is necessary to free up the cabling from the rear area beforehand, and bring it to the front area.

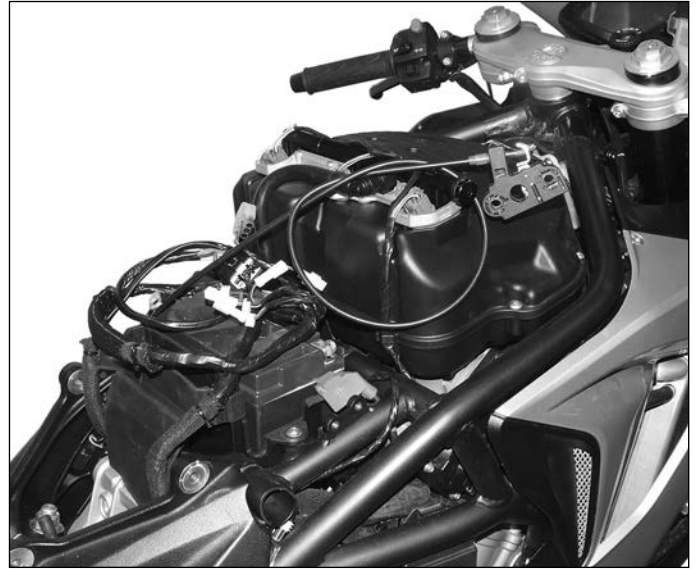

Remove the four (two on each side) frame fixing screws.
Hold the frame up before removing the last screw.

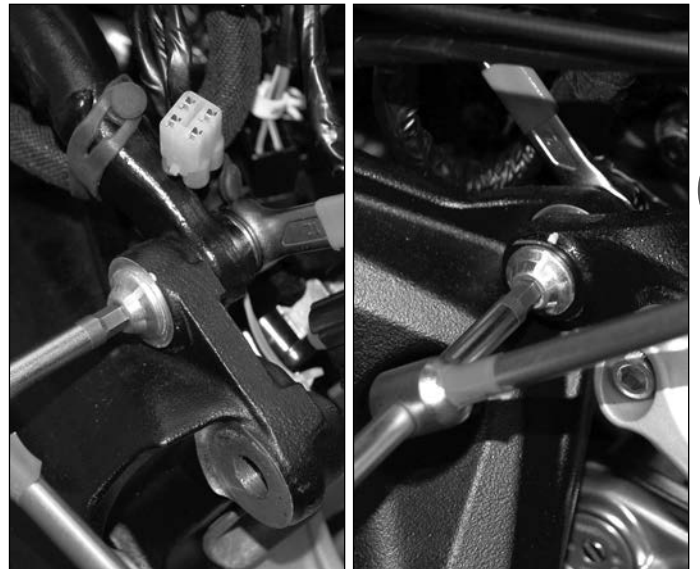

Remove the rear frame from the vehicle.

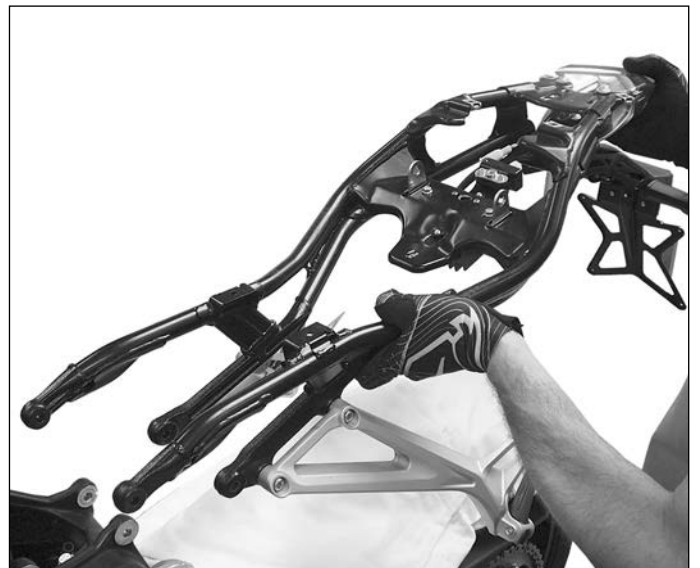



Frame

FRAME PLATE REMOVAL

Cut the chain as described in chapter F "Suspension and Wheels."

Remove the brake oil tank in the inside of the right plate.



Loosen the nut on the rh bottom engine pin.



Loosen the rh side swing arm pin screw.





Frame

Loosen the nut on the screw that joins the plates on the rh side.



Loosen the nut on the top damper connection.



Counter the suspension rocker arm with a support.





Frame

Remove the nut on the rh side plate rocker arm pin.



Take out the lh side plate rocker arm pin.



Remove the nut from the top damper connection, being careful not to let the suspension fall.





Frame

Remove the screw on the rh side swing arm pin.



Remove the screw and nut that join the plates.



Remove the nut of the rh side bottom engine clamping pin.



G



Frame

Remove the right plate along with the bushing.

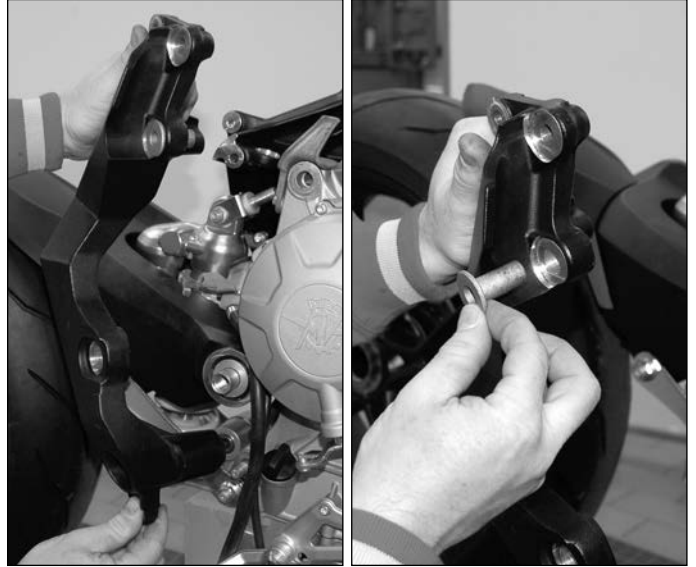

Remove the left plate with relative pins..



After these operations the engine is separate from the rear suspension.

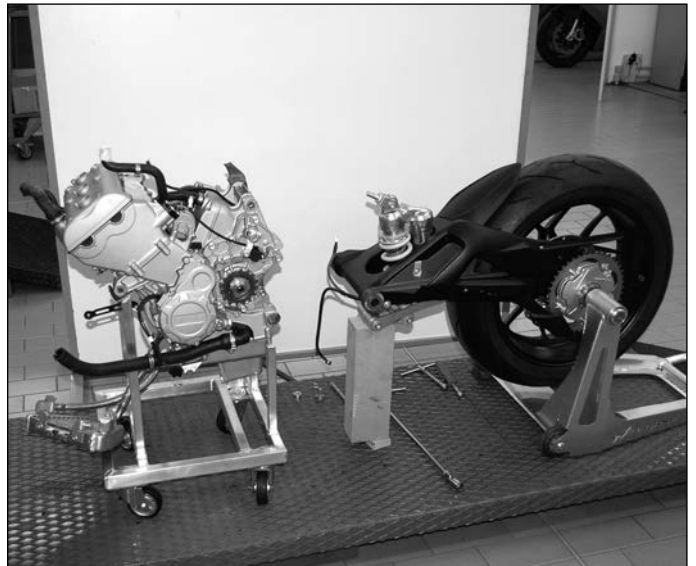



Frame

RE-ASSEMBLY OF THE VEHICLE

To re-assemble the vehicle in an easy fashion, do the following:

- position the engine on tool 8000B6789
- assemble the following parts:
 - 1) engine earth cable
 - 2) electrical system protection
 - 3) engine oil vapour vent pipe
- proceed in the reverse order of disassembly of the frame plates

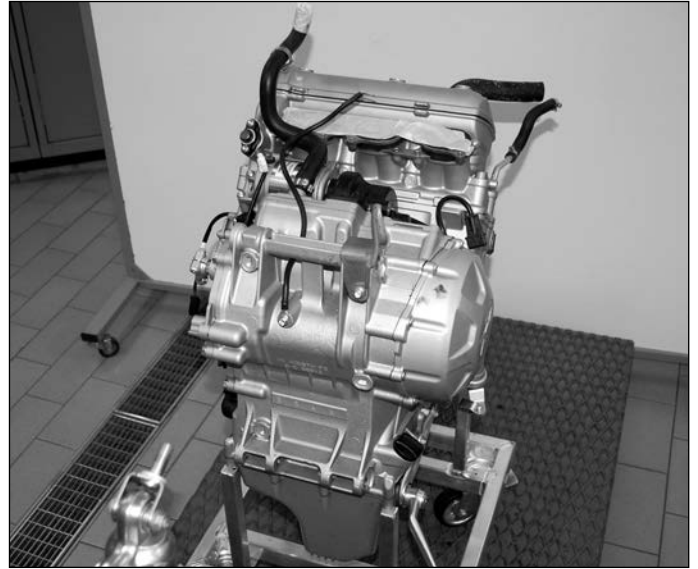

REAR FRAME UNIT ASSEMBLY

To assemble the rear sub-frame unit to the motorcycle, proceed in the reverse order of removal. Tighten the four fixing screws, two on each side, to the prescribed torque pressure.



Torque pressure: 24 ÷ 28 N·m
(See page 33).

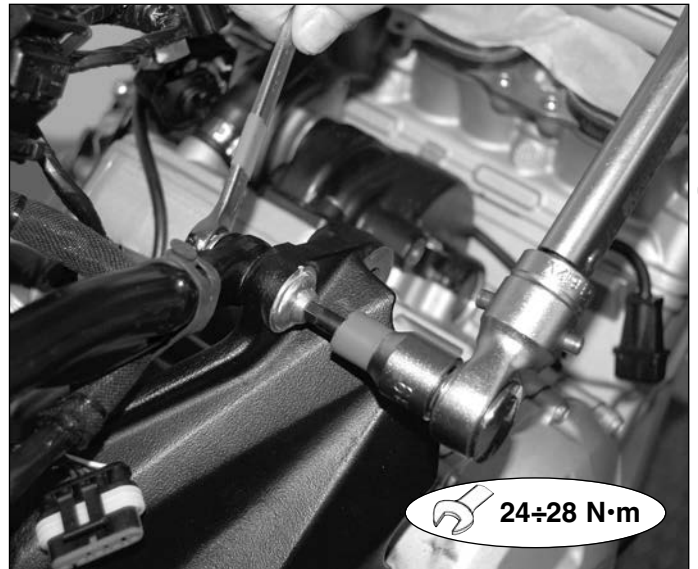

G



Frame

EXHAUST VALVE TRANSMISSIONS ASSEMBLY AND ADJUSTMENT

Take out the exhaust valve actuator (Code 8000B2126) and make sure that the top opening (1) on the pulley is aligned with the symbol (2).

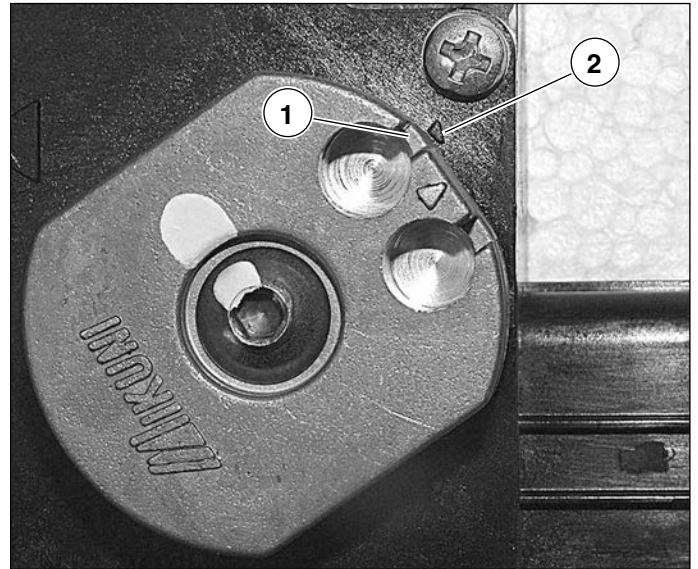

Position the terminals on the exhaust valve actuator as shown in the figure. Push the sheaths of the transmissions (3) until they touch the actuator.

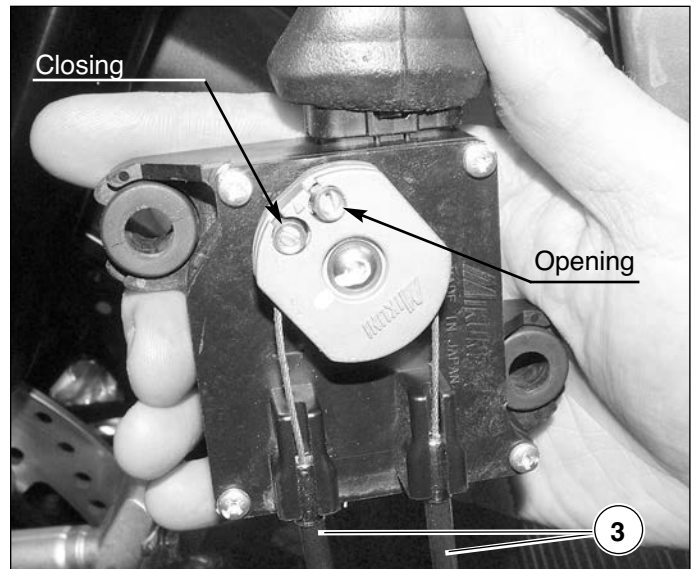

Be careful to make the cables correspond with the relative opening (4) and closing (5) functions (the opening transmission has an additional collar on the terminal from the exhaust valve line).

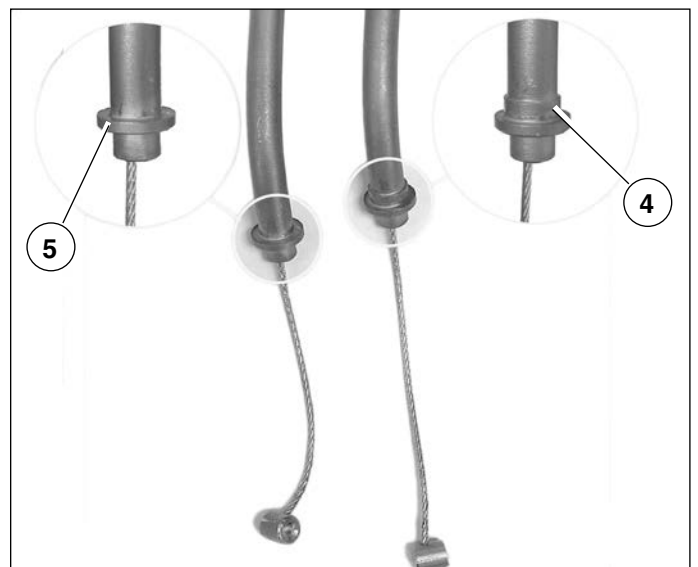



Frame

Arrange the transmission cables for the exhaust valve along the left side of the motorcycle. Position the terminals on the bracket and on the exhaust valve as shown in the figure. Be careful to make the transmissions correspond with the relative opening (2) and closing (1) functions.

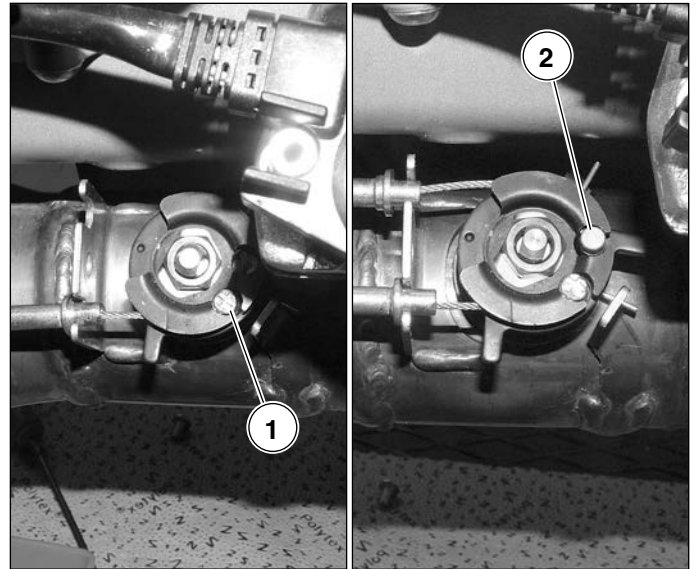

Insert the front clamping plate (code 8000B7047) onto the bracket.

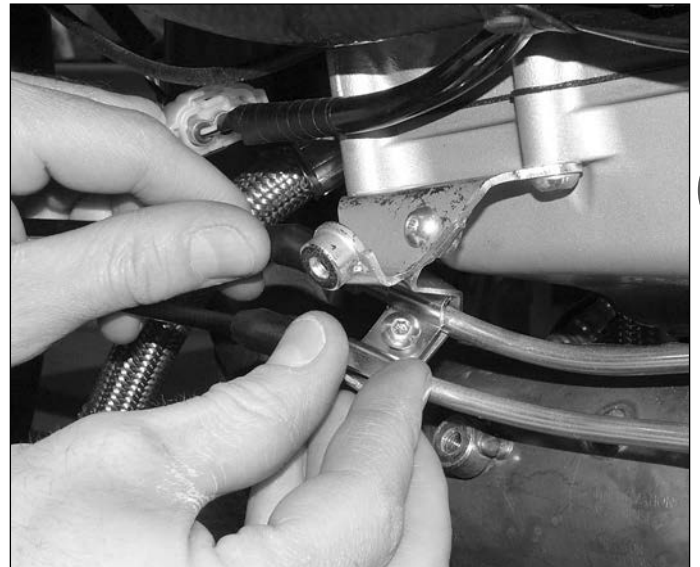

Insert the M5 clamping screw (code 8000B4221) onto the plate. Tighten the screw to a max torque pressure of 2 Nm.

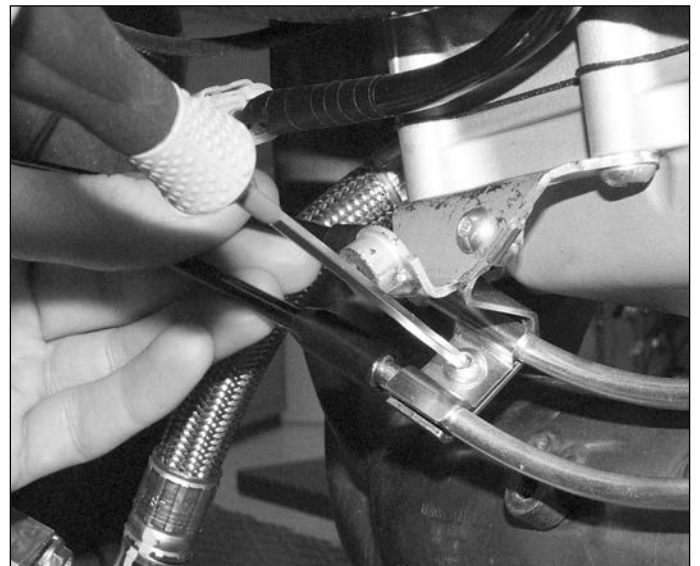

G



Frame

Insert the clamping plate (code 8000B4110) onto the bracket.

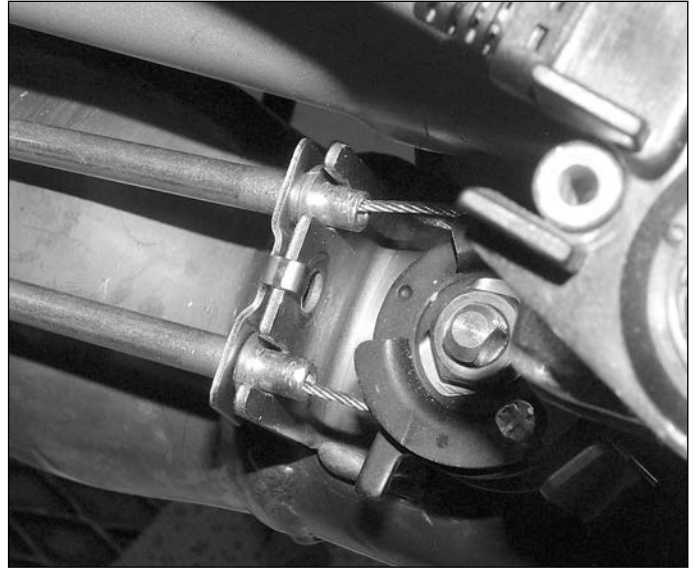

Insert the M5 clamping screw (code 8B00B2680) and M5 nut (code 8000B2707) onto the plate. Tighten the fastening elements to the max required torque.

 **Torque pressure: clamp. screw Plate: 2 N·m**

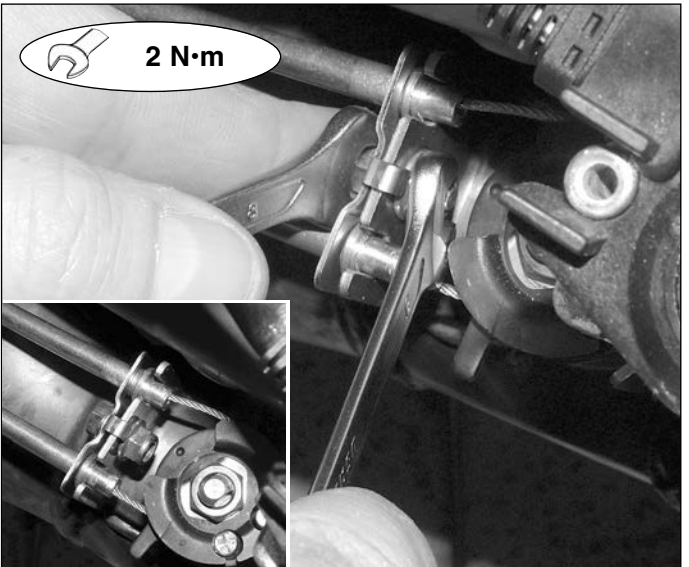

Slide off the rubber caps from the transmissions to free up the adjusters.

Regulate the adjusters on both the opening and closing transmissions.





Frame

Proceed with the adjusting procedure of the opening and closing transmissions so as to place the bottom pulley lock against the plate (1). Make sure that in this position the transmissions are adjusted with a clearance that allows the pulley to rotate slightly.

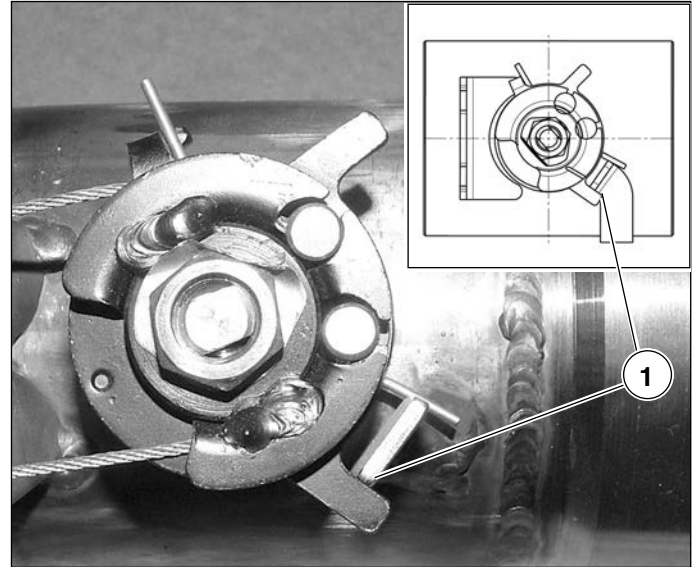

Carry out the self-learning procedure on the all the way open/all the way closed positions of the valve. This procedure recognises the stop limits of the exhaust valve, to then automatically defines the extreme positions of pulley operation.

Tighten the opening and closing transmission adjusters as shown in the figure.

 **WARNING:** After the opening and closing transmission adjusters have been tightened, make sure that they have not been adjusted with an excessive clearance or excessive tension.



Slide the rubber caps onto the adjusters of both transmissions.

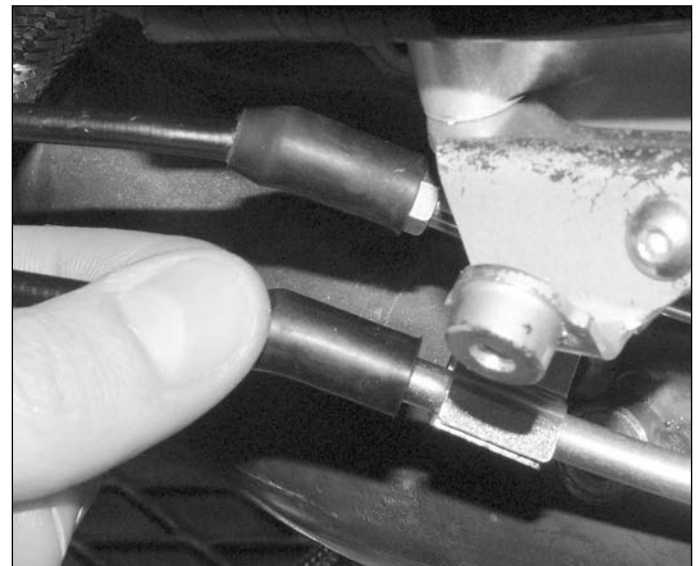

G



Frame

Fasten the exhaust valve actuator (1) by inserting it on the clamping pegs (2) located on the inside of the side panelling of the lh side panel fairing as shown in the figures.

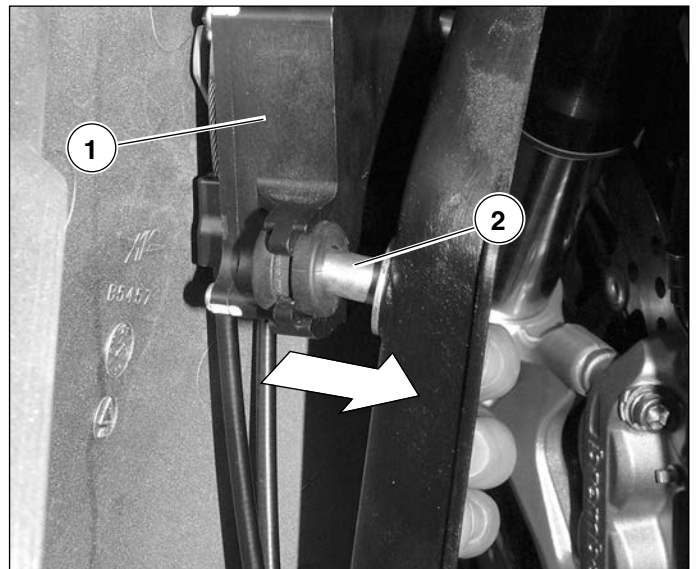
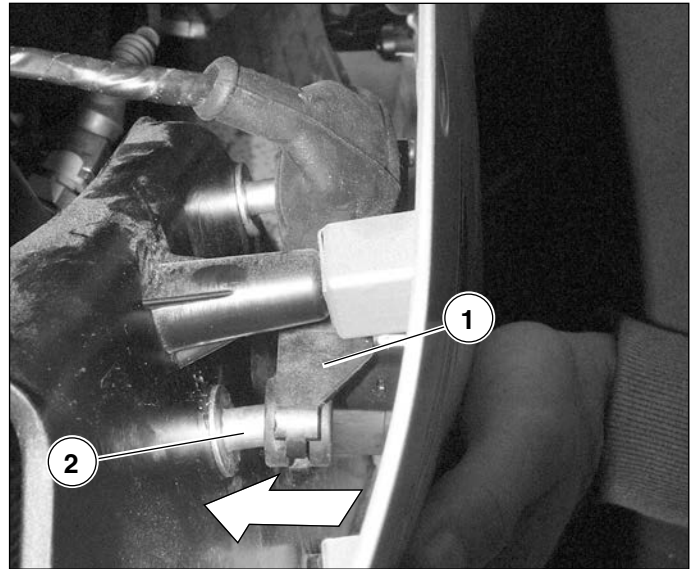



Brakes

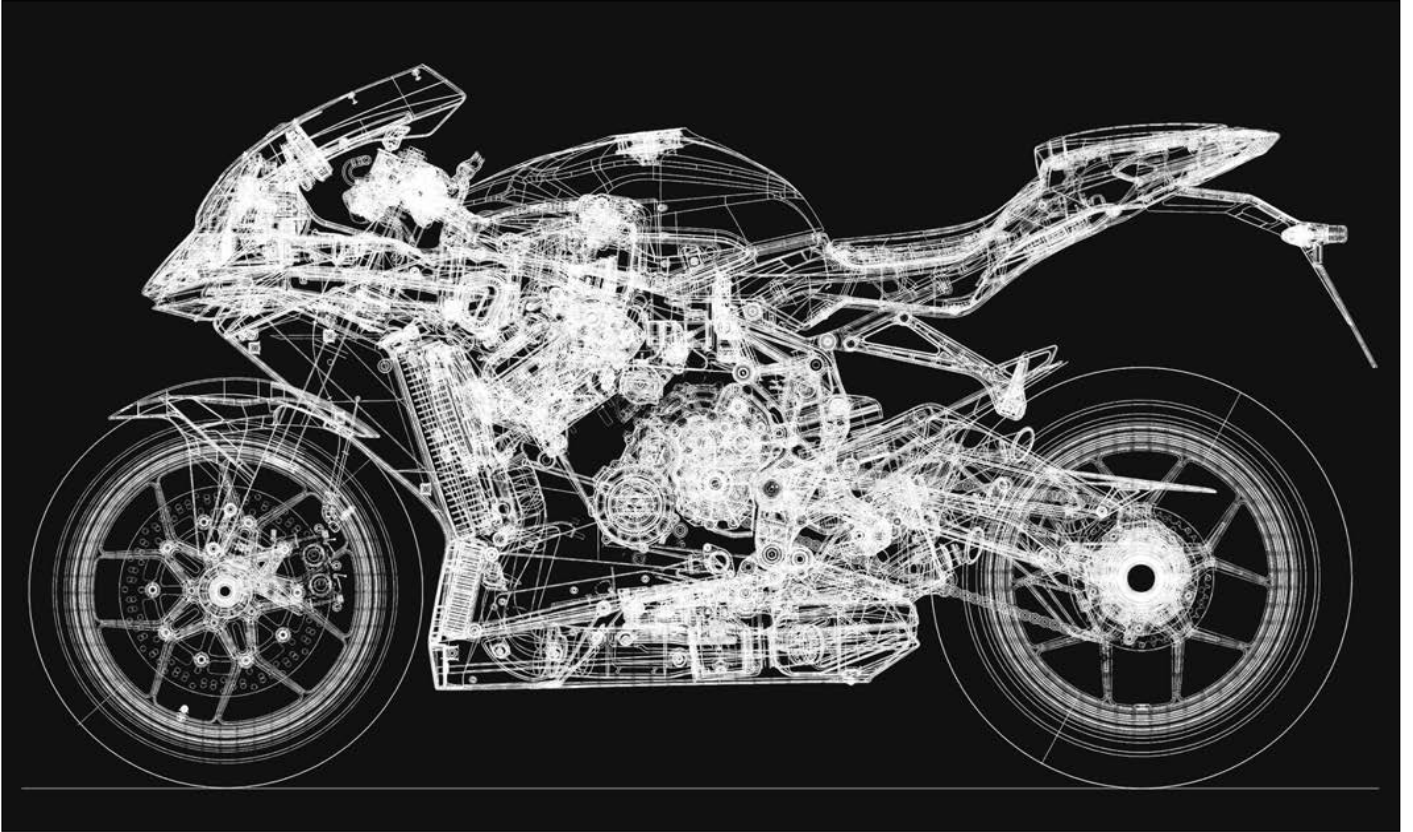

H

SECTION H
Revision 0



Brakes

SUMMARY

FRONT BRAKE SYSTEM	PAG. 3
FRONT BRAKE PADS SUBSTITUTION (F3 675)	PAG. 4
FRONT BRAKE PADS SUBSTITUTION (F3 ORO)	PAG. 6
SUBSTITUTION AND BLEEDING OF THE FRONT BRAKE FLUID	PAG. 8
FRONT BRAKE CALIPERS SUBSTITUTION	PAG. 13
FRONT BRAKE PUMP REMOVAL	PAG. 14
REPLACING THE BRAKE FLUID BASIN AND CONNECTING PIPE TO THE PUMP	PAG. 16
REPLACING THE FRONT BRAKE SWITCH	PAG. 17
BRAKE LEVER REMOVAL	PAG. 18
FRONT BRAKE DISCS	PAG. 19
FRONT BRAKE DISC REMOVAL	PAG. 20
REAR BRAKE SYSTEM	PAG. 22
REAR BRAKE PADS SUBSTITUTION	PAG. 23
SUBSTITUTION AND BLEEDING OF THE REAR BRAKE FLUID	PAG. 25
REAR BRAKE CALIPERS SUBSTITUTION	PAG. 27
REAR BRAKE DISC	PAG. 30
REAR BRAKE DISC REMOVAL	PAG. 30



Brakes

FRONT BRAKE SYSTEM

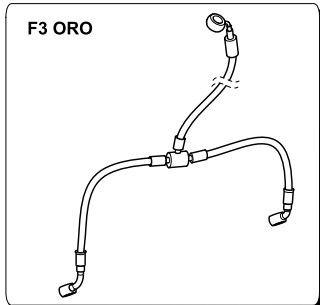
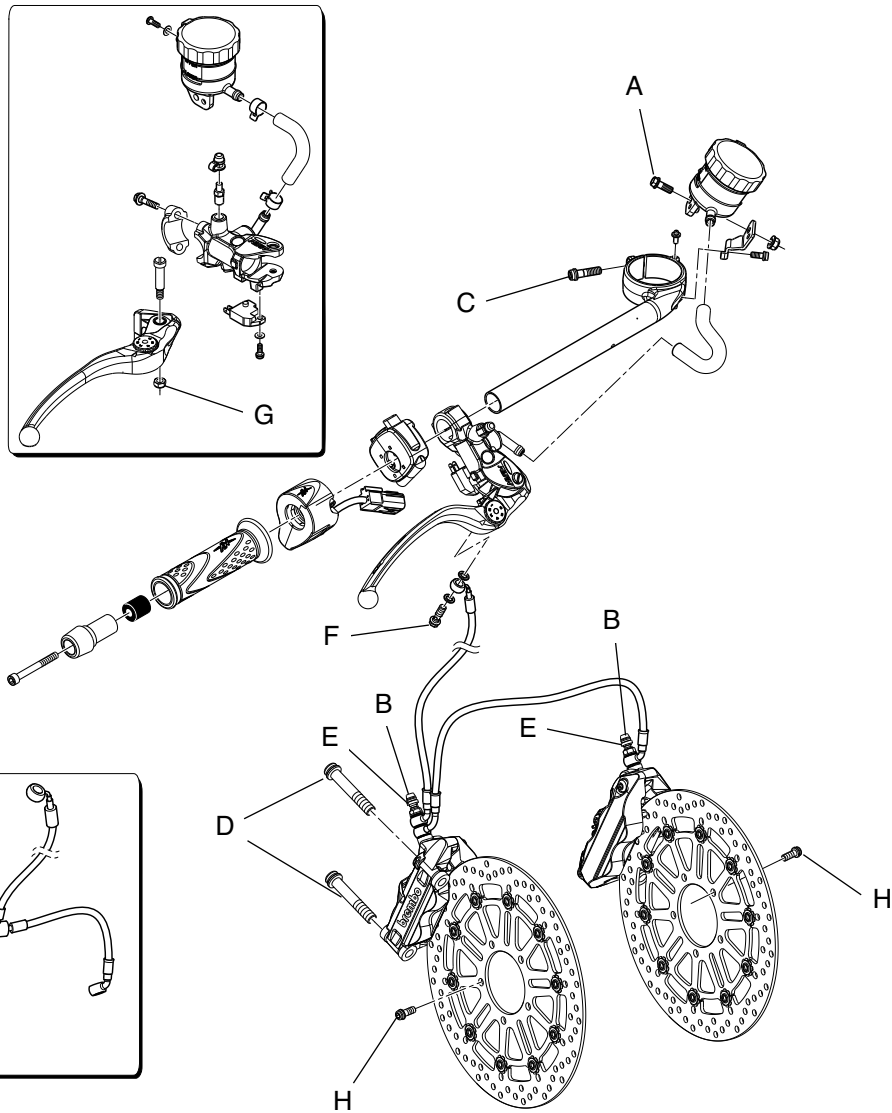

		A	B		C	D	E	F	G	H			
			F3 675	F3 ORO									
Torque pressure	N·m	8	6	8	8 ÷ 10	42 ÷ 46	23 ÷ 26	16 ÷ 18	5 ÷ 7	23 ÷ 25			
	Kg·m ft·lb												
Operation													

Description	F3 675	F3 ORO
FRONT BRAKE		
Type	Dual floating disc with steel braking band	
Ø discs (mm)	320	
Disc flanges	Aluminium	
Calipers (Ø pistons mm)	Radial-type, with 4 pistons Ø 32	Radial-type, single-piece with 4 pistons Ø 32
Front disc thickness (mm)	5	
Min. pad thickness (mm)	1	

It is advisable to remove the parts of the bodywork as described in the chapter "Bodywork" that could obstruct normal operations, before proceeding with the overhaul of the front brake system.



Brakes

FRONT BRAKE PADS SUBSTITUTION (F3 675)

Using pincers, position the pin (1), in such a way as to facilitate seeger removal.

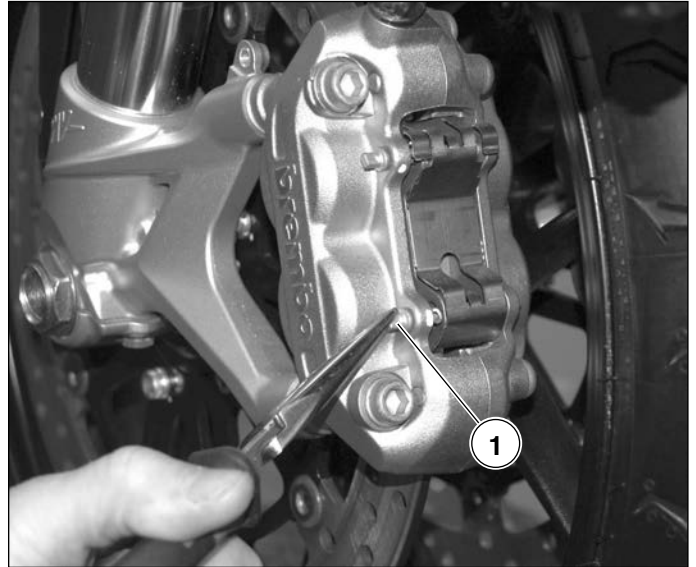

Remove the two seegers (2), one for each pin.

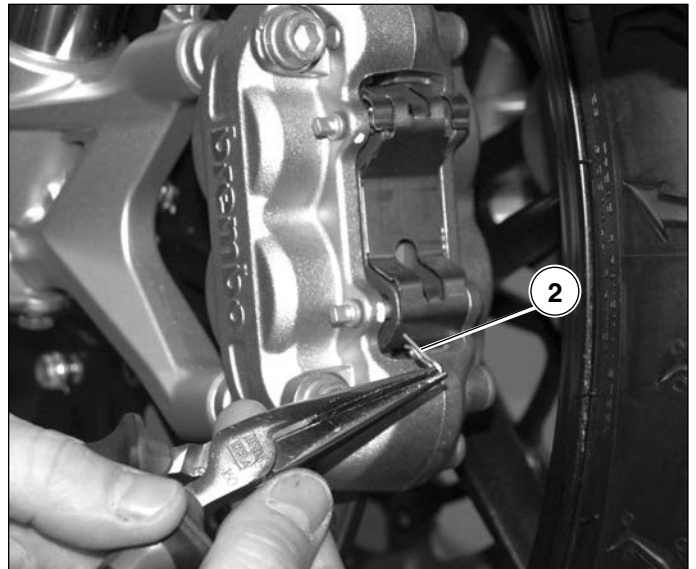

Remove the two pins (1) and remove the pad cover (3).

NOTE: Re-assemble the pad cover with the stamp of the arrow turned upwards.

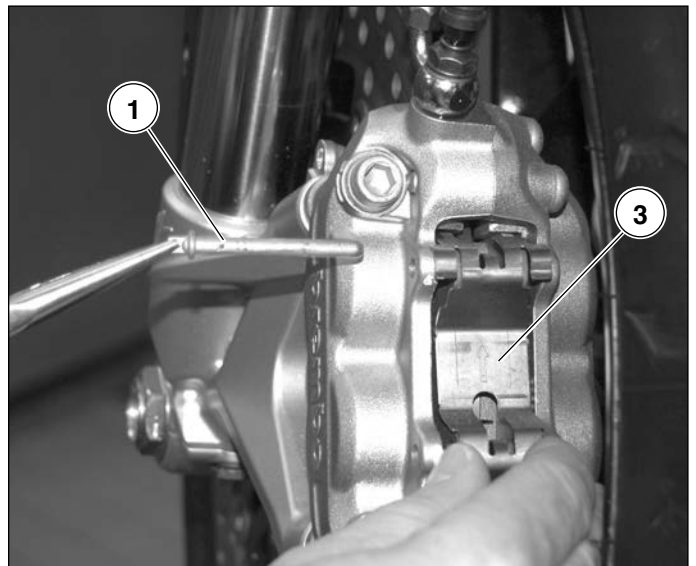



Brakes

Widen the pads before taking them out.

Remove the two pads from the caliper.
Repeat the same disassembling procedure for the other caliper.

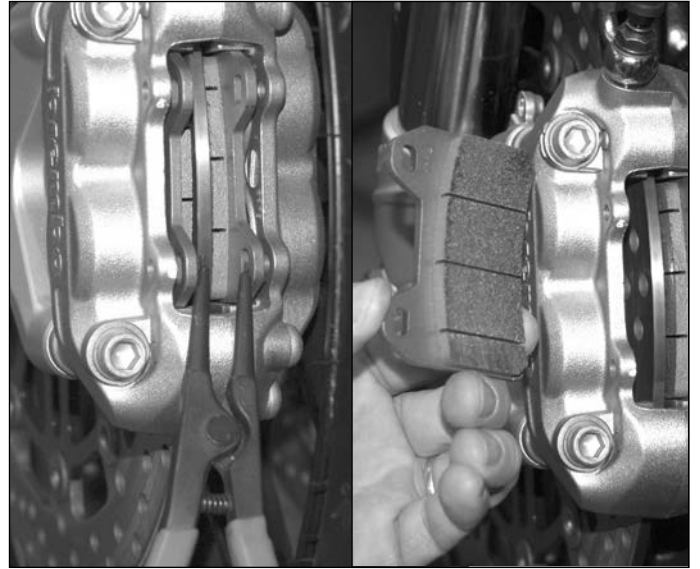

Every 6000 kilometres, check the wear of the pads.
The pad thickness must not be less than **1 mm**. If the pads are excessively worn, substitute them.

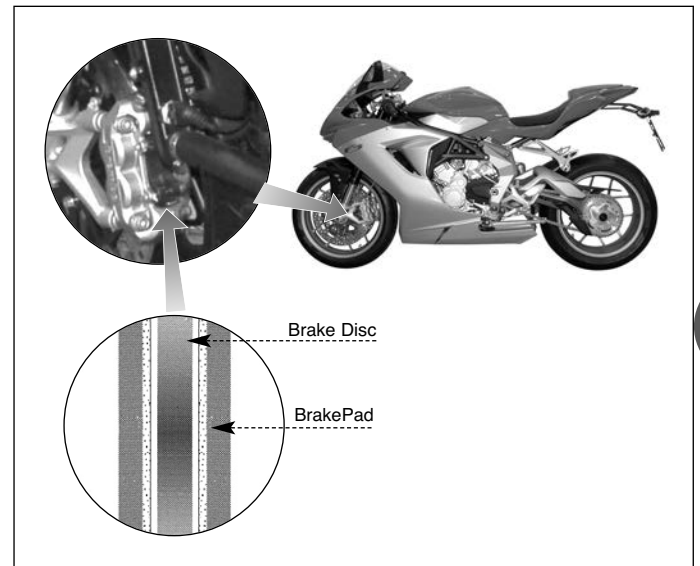

For setting up front brake pads, carry out the operations described above in reverse order.

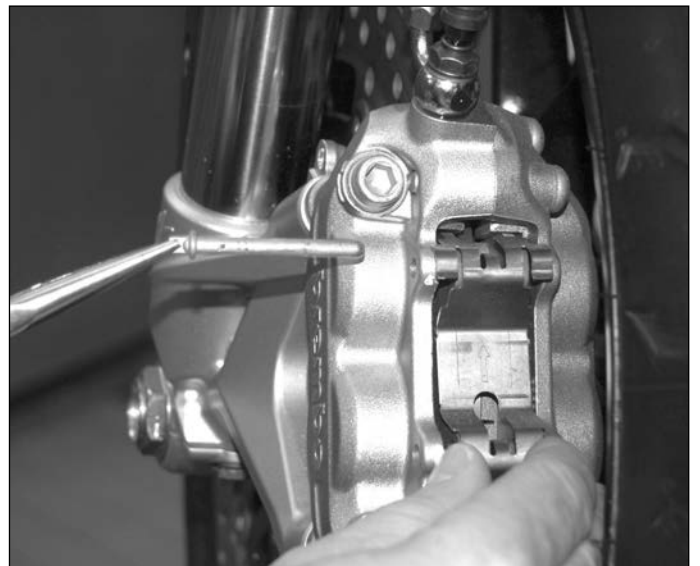



Brakes

FRONT BRAKE PADS SUBSTITUTION (F3 ORO)

To replace the front brake pads, remove the front brake caliper, as detailed in the “Suspensions and Wheels” section.

Widen the pads with a screwdriver so that the pistons are pushed back into their seats (as shown in the figure).



The movement towards the outside of the brake pads makes the pistons go back into their seats, with the consequent increase in the level of the brake fluid in the brake fluid chamber.

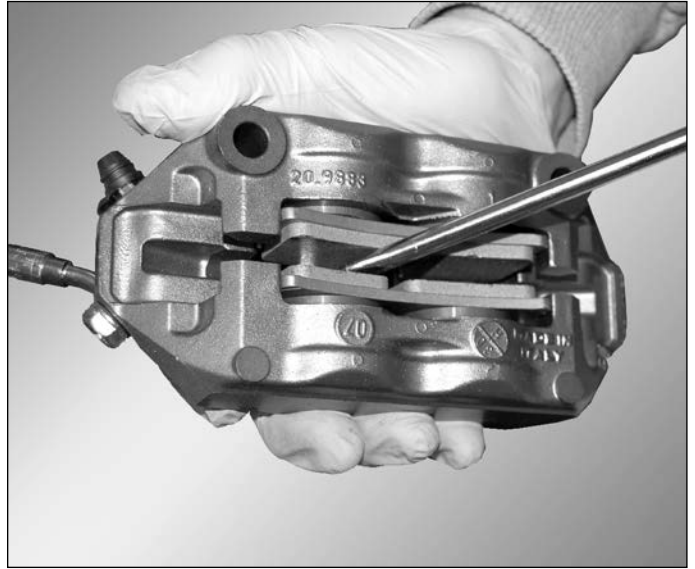

Move either pad to the centre of the opening and pull it out of the caliper. Repeat on the other pad.

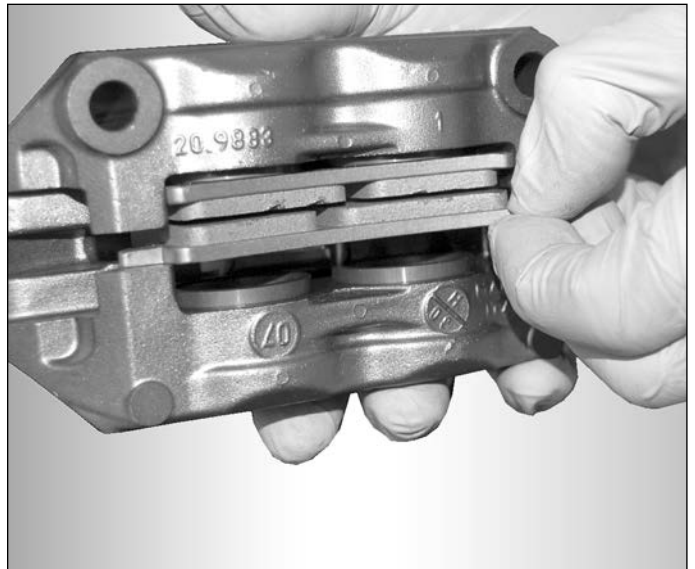

Every 6000 kilometres, check the wear of the pads. The thickness of the friction material must not be less than 1 mm. If the pads are excessively worn, substitute them.

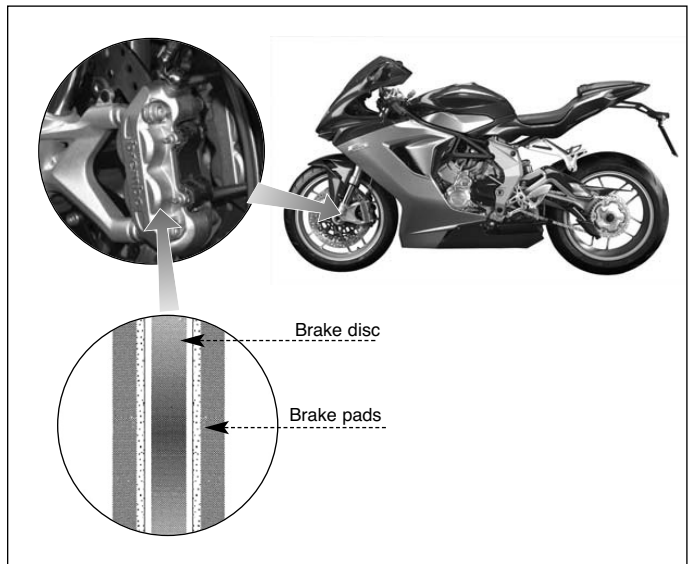



Brakes

Before fitting the pads back in, make sure the plate rests against its stop. If it does not, push it down, as shown in the Figure.



Fit either pad through the midst of the front back caliper opening, then push it towards its pistons. Do the same with the other pad.

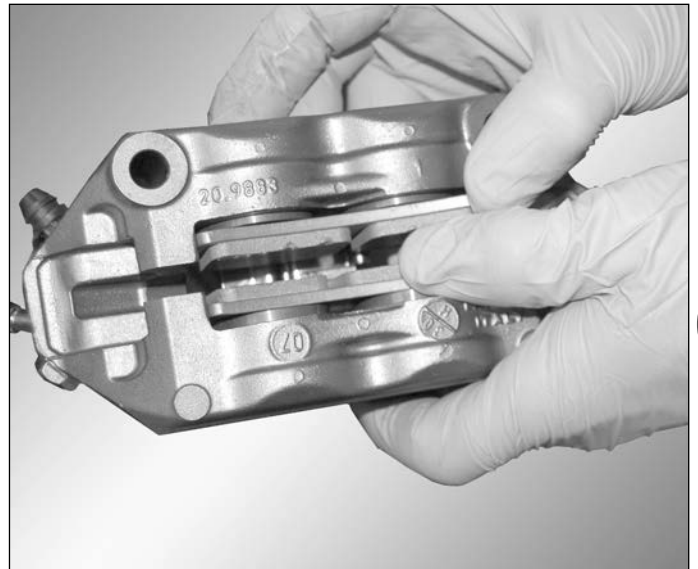

Fit the caliper back in but do not tighten the screws.

Operate the front brake lever to position the pistons (pushing against the pads).

While pulling the front brake lever, tighten the caliper screws to the right torque.



Torque pressure calipers: 42÷46 N·m

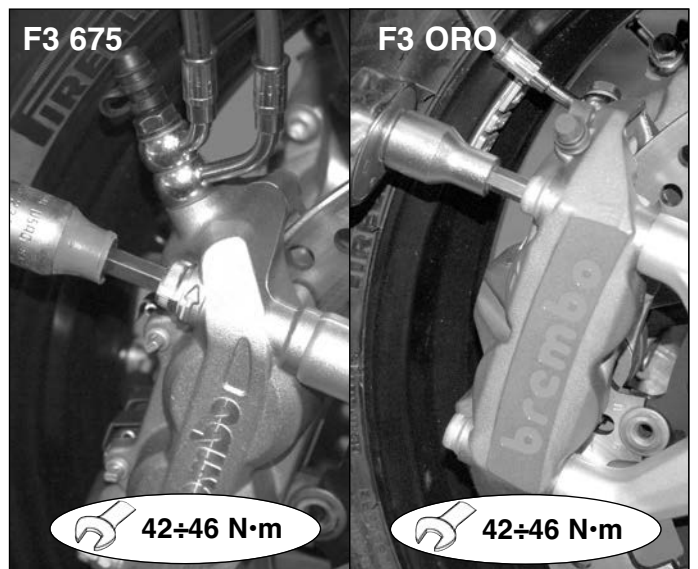



Brakes

SUBSTITUTION AND BLEEDING OF THE FRONT BRAKE FLUID

Place the motorcycle on a horizontal surface with the steering in a straight line.

In order to have more space to move, it is advisable to remove the cowl.

Remove the screw (1) for the tank cap safety tab.

Unscrew the tank cap (2).



Brake fluid has a strong corrosive power.

Be careful to not spill the fluid on surrounding parts.

If the fluid is spilt clean immediately with industrial alcohol and dry with compressed air.

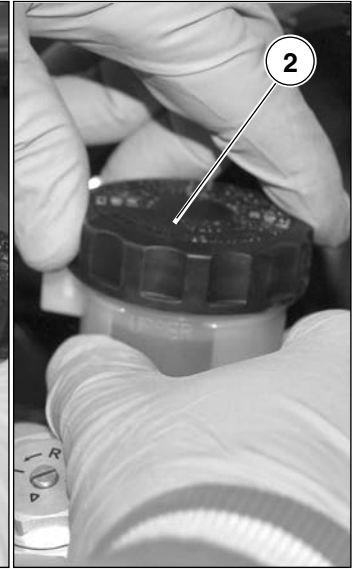
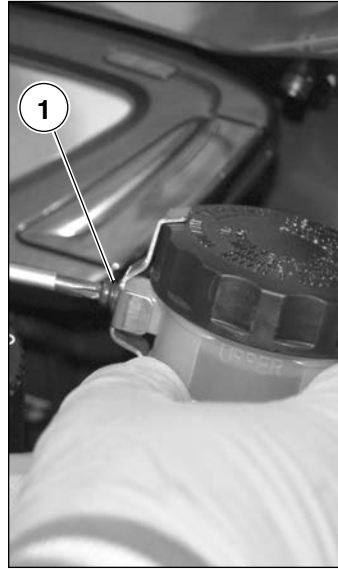

Remove the protection cap of the bleed valve of the front right caliper.

Position the wrench, then apply a rubber tube to the bleeder screw of both calipers, right and left (on top of the brake calliper).

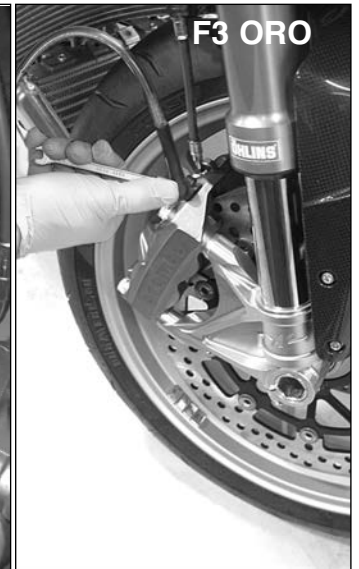
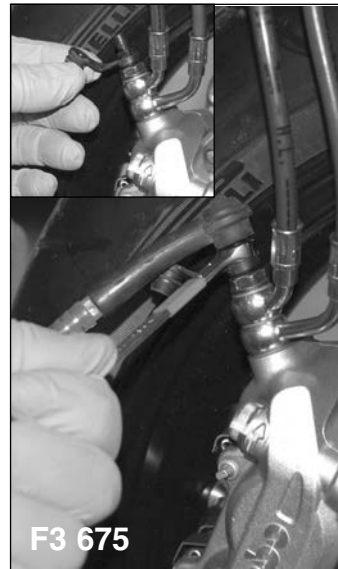

Put the other end of the rubber tube in a suitable container.





Brakes

Pull the brake lever without releasing it.
Slacken the bleed valve and empty the brake system.

Tighten again the bleeding screw, before releasing the
brake lever.



Fill the system by pulling the front brake lever 3-4 times
(see figure).

Repeat the above drain operations until the fluid reaches the minimum level in the reservoir. Top up with fresh fluid and carry on with the operation until fluid of a different colour (fresh) flows out.

The quantity of brake fluid necessary for this operation is approximately 250 cc.

NOTE Repeat this operation on both calipers.



Brake Fluid : AGIP Brake 4



Utilise only the prescribed brake fluid from sealed containers. NEVER use old or used brake fluid.



Tighten the bleed screw, remove the rubber tube, carefully clean the screw with alcohol, blow it dry and put the protective cap back on.



Bleed screw tightening torque: 6 Nm (F3 675)
Bleed screw tightening torque: 8 Nm (F3 ORO)



H



Brakes

Remove the protection cap of the bleed screw of the caliper.
Introduce an 8mm wrench and connect the rubber tube for collecting the brake fluid.



Holding the brake lever engaged, loosen the bleeder screw and close it back up, all the while engaging the brake lever.
Repeat the aforementioned operation 3 or 4 times.



Slowly squeeze the brake lever to bring the pads in contact with the disc and also checking that there is no sponginess in the action of the lever. Air bubbles should not rise in the chamber.
If bleeding has been carried out correctly, the stroke of the lever will be short and will not have an elastic effect.

Otherwise, repeat the bleeding operations illustrated in the points above.





Brakes

Pour new brake fluid into the chamber until it reaches the maximum level.



Brake Fluid : AGIP Brake 4



Utilise only the prescribed brake fluid from sealed containers. NEVER use old or used brake fluid.



Top-up the level of the fluid until it reaches the maximum mark (upper).



Carefully clean around the edge of the brake fluid chamber utilising a clean cloth.



Imperfect cleaning of this component could cause the loss of small quantities of brake fluid whilst riding.





Brakes

Accurately clean the three elements of the brake fluid chamber cap with alcohol and dry with compressed air.



Position and screw on the top brake fluid tank cap firmly holding onto the tank.

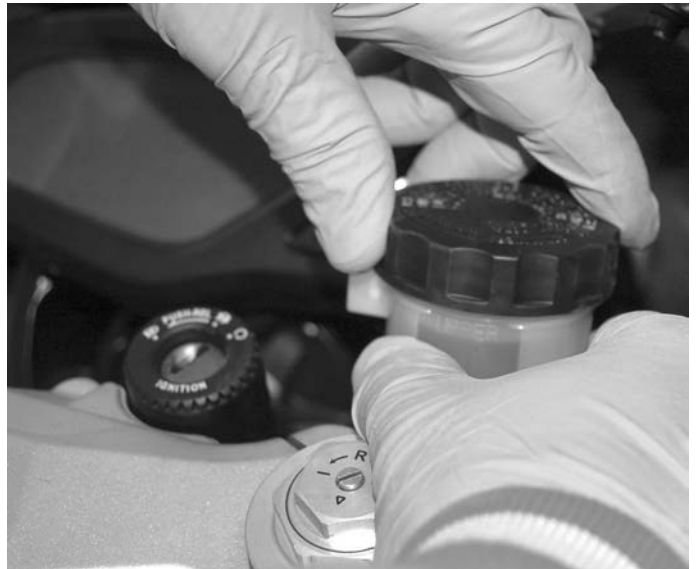

Reposition the safety tab and fasten it on with the screw that was removed previously.



FRONT BRAKE CALIPERS SUBSTITUTION

- Slightly move the front brake lever towards the right handgrip and hold it in position with a strap to limit the outflow of brake fluid during subsequent operations.
- Unscrew the fitting with a 12mm key, being careful to avoid spilling any brake fluid.



Brake liquid can corrode painted surfaces. Clean immediately any spilt brake liquid.

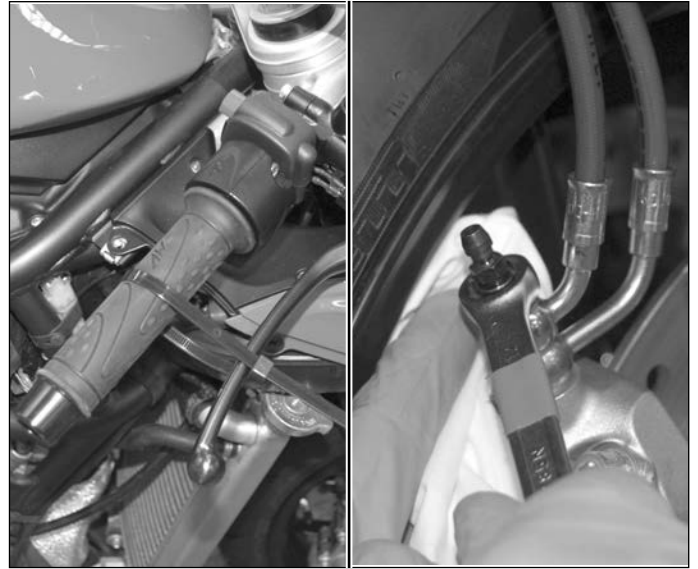

- Remove the 3 sealing washers, and change them in the assembly phase with new ones.
- Remove the two caliper fixing screws indicated in the figure.

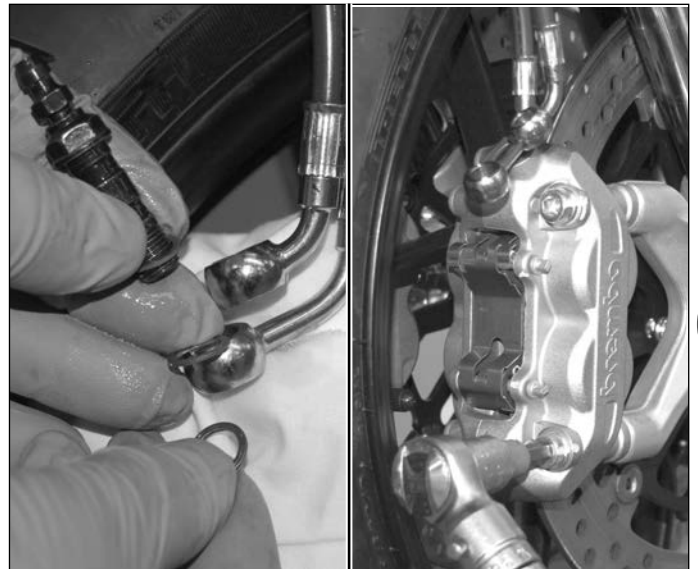

- Remove the brake caliper.

NOTE The removal operation is identical for both calipers.



H



Brakes

To fit the front brake calipers, follow these steps:

- Insert the caliper fixing screws and turn them until they make contact.



Only grease the first threads of the brake caliper fixing screw.

- Refit the caliper connection after replacing the sealing washers.



Torque pressure caliper union: 23÷26 N·m

- Fill the system with brake fluid.
- Bleed the system as described on page 6.
- Keep the brake lever pulled back with a strap and tighten the brake caliper fixing screws.



Torque pressure calipers screws: 42÷46 N·m



FRONT BRAKE PUMP REMOVAL

Remove the cap from the front brake fluid reservoir and drain the reservoir with a syringe.



Remove the clamp (1) on the brake pipe for the electrical system.

Remove the two faston (2) of the electrical system.

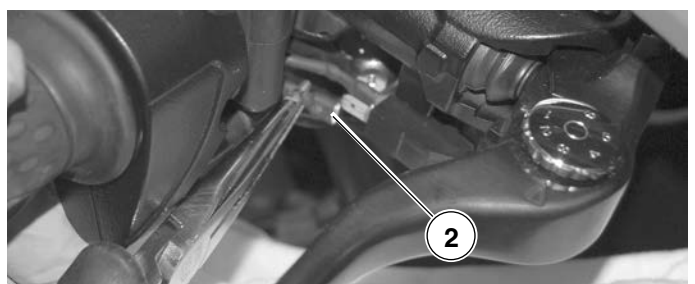
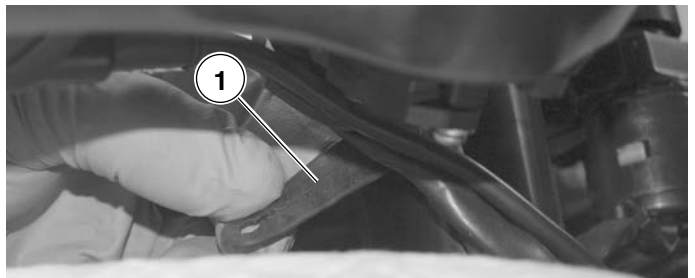



Brakes

Remove the union (3) indicated in the figure.



Brake fluid is extremely corrosive. Avoid contact with the eyes, skin and nose. Wash abundantly with water and call a doctor if accidental contact occurs.



During the following operations, avoid contact with painted surfaces.



Remove the screw that clamps the tank to the steering head.

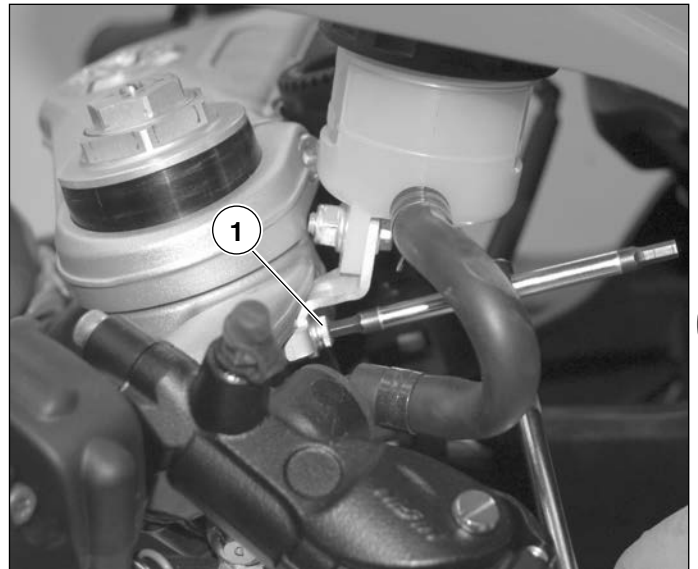

Remove the two fixing screw (1) that fixes the pump to the handlebar.
Remove the clamp and take out the pump.



H



Brakes

During the assembly phase, be careful of the position of the brake pipe fitting and use two new washers.

Place the pump close to the handlebar pipe and fasten it with the clamp being careful that the "UP" sign is facing upwards and that the position of the pump corresponds to the reference marked on the handlebar pipe.

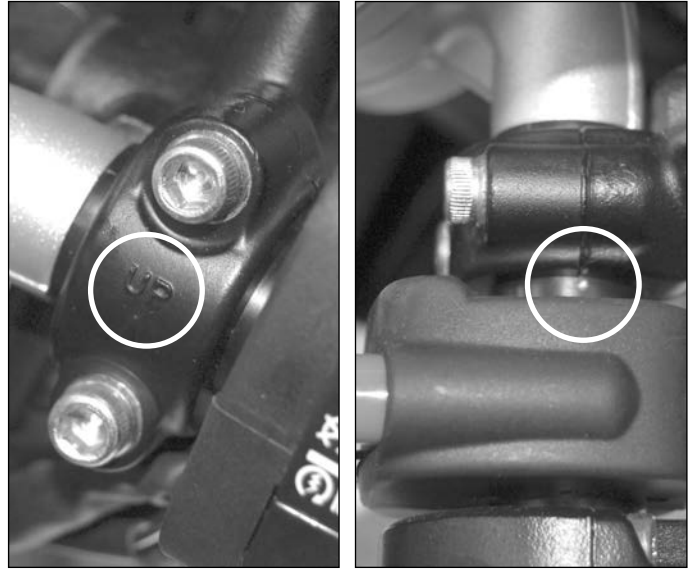

REPLACING THE BRAKE FLUID BASIN AND CONNECTING PIPE TO THE PUMP

Remove the screw that clamps the plate to the tank.



Loosen the retaining clamp (1) and slide it out of the work area.
Disconnect the pipe from the basin.

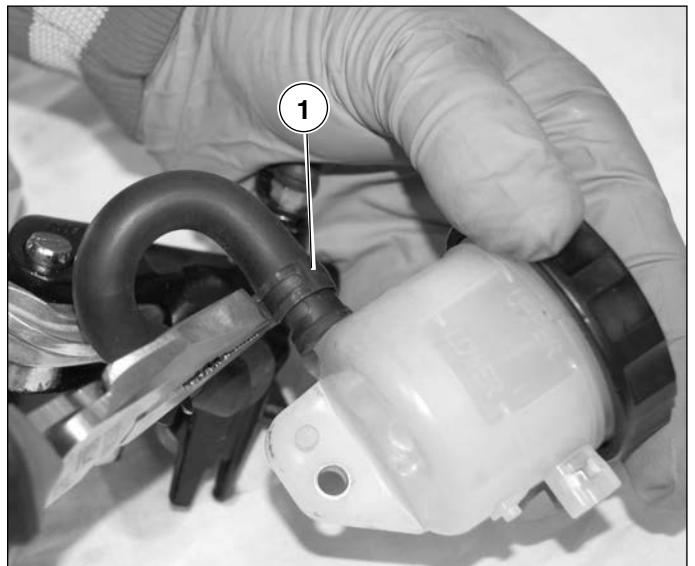



Brakes

Make sure that the connecting pipe to the pump does not have any cracks or signs of wear. If necessary replace it by loosening the retaining clamp, sliding it out from the work area and pulling out the pipe from the pump line as well.

To re-assemble it perform the procedure in reverse order, being careful of the pipe position and orientation.



REPLACING THE FRONT BRAKE SWITCH

To replace the front brake switch, remove the screw shown in the figure.



After having carried out the overhaul of the front brake pump assembly, carefully wash and bleed the front brake system as previously described in this chapter.



During the re-assembly phase align the switch centring pin with the marking on the pump.



BRAKE LEVER REMOVAL

Remove the nut shown in the figure.



Unscrew the pin.
Remove the brake lever.



 When reassembling, be careful to insert the pin of the pump piston into the seat situated on the lever (see figure).

Grease the pin:



Recommended grease: Agip Grease 30





Brakes

For the reassembly of the lever tighten the pin.
Tighten the nut while holding the pin in place with a flat blade screwdriver.



Torque pressure: 5 ± 7 N·m



FRONT BRAKE DISCS

Check the thickness of the front discs utilising a micrometer gauge and measure three points at least with 120° between them as shown in the figure.



Use a micrometer gauge for this check.

- Minimum allowable thickness: 4.5 mm

This operation just be carried out on both front discs.



If the measurements are below the minimum, substitute the component with a new one.



H



Brakes

FRONT BRAKE DISC REMOVAL

Take down the front wheel as described in chapter F "Suspensions and Wheels".

Place the wheel in a horizontal position and remove the five screws of each disc proceeding in a star-like mode for the removal.

Visually check the discs for lines or score marks.



Place the brake disc on a level surface with the milled side face down and utilising a micrometer gauge check that the maximum oscillation of the disc reached during a rotation of 360° does not exceed **0.3 mm**.



Utilise a micrometer gauge for this check



If the measurements are below the minimum, substitute the component with a new one.

This operation must be carried out on both front discs.

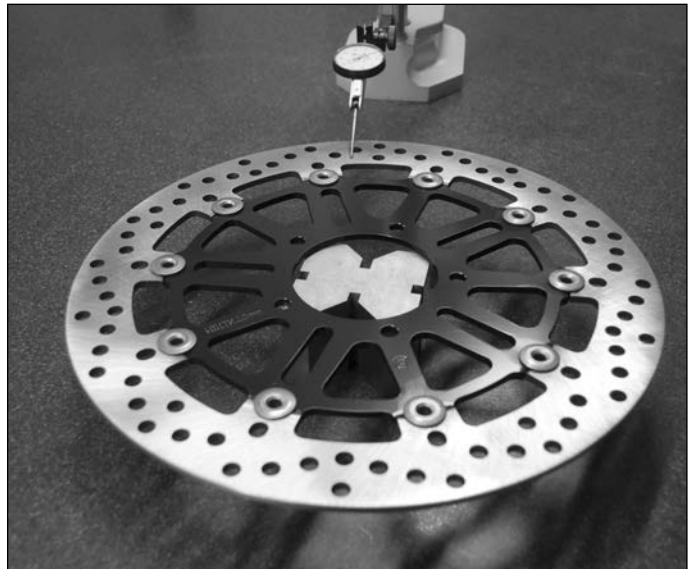

Front disc assembly

Thoroughly clean the contact surfaces of the discs and the wheel.

Accurately grease all relative surfaces of the disc before reassembling.





Brakes

The following operation is to be carried out on all models.

If newly supplied screws are being used they already have threadlocker on them.

Apply thread-locking fluid to the five fixing screws of the disc.



Recommended thread-locking fluid : Loctite 243



Screw in the screws lightly, proceeding in a star-like mode.

Continuing in a star-like mode, tighten the screws to the prescribed torque pressures.



Torque pressures: 23 ÷ 25 N·m

Be careful to reassemble the discs in the original positions (it is advisable to mark them by applying an adhesive label).



This operation is important so that a good contact between the brake discs and the relative pads.

Proceed by reassembling the parts in the reverse order of removal. Consult chapter F "Suspension and wheels"



H

REAR BRAKE SYSTEM

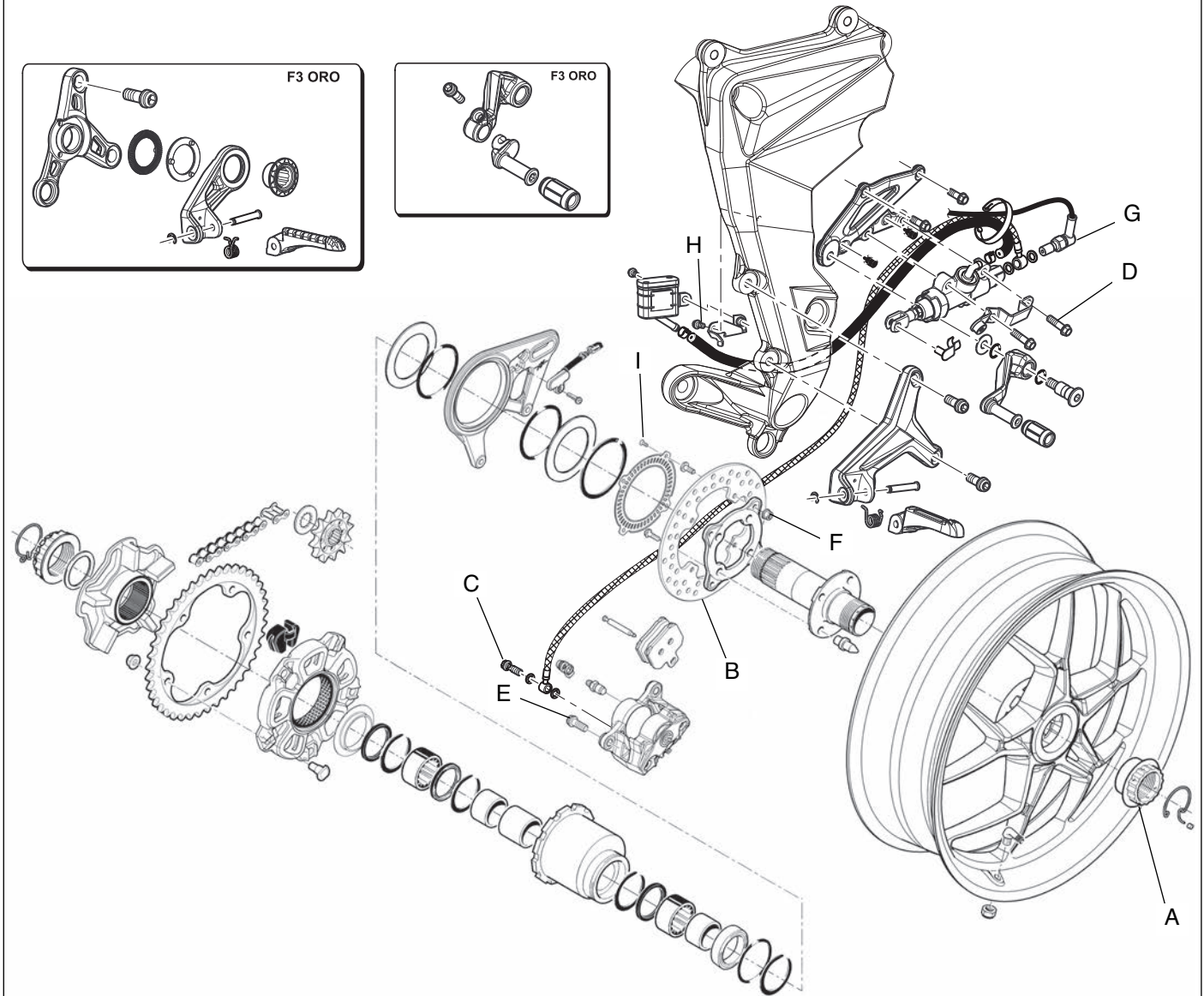

		A	B	C	D	E	F	G	H	I
Torque pressure	N·m	220 ÷ 240		23 ÷ 26	8 ÷ 10	18	18 ÷ 20	16 ÷ 18	8 ÷ 10	3
	Kg·m									
	ft·lb									
Operation						243	270			243

Description	F3 675	F3 ORO
REAR BRAKE		
Type		Single steel disc
Ø discs (mm)		220
Caliper (Ø pistons mm)		With 2 pistons Ø 34
Rear disc thickness (mm)		5
Min. pads thickness (mm)		1



Brakes

REAR BRAKE PADS SUBSTITUTION

Remove the safety retainer and unscrew the rear ring nut by turning it clockwise (see figure).

Remove the wheel.

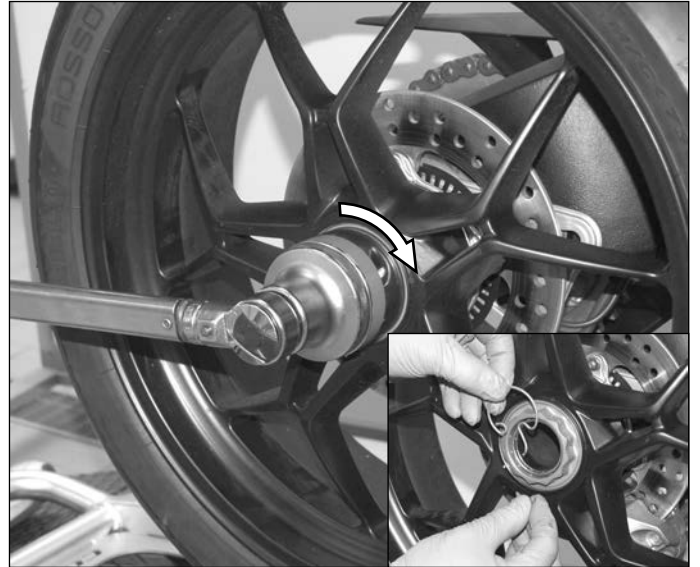

Utilising circlip pincers as shown in the figure, widen the pads so that the pistons are pushed back into their seats.

 The outward movement of the brake pads provokes the retraction of the pistons in their relative seats, with a consequent increase in the level of the brake fluid in the brake fluid chamber.



Take the locking ring off, as shown in the figure.

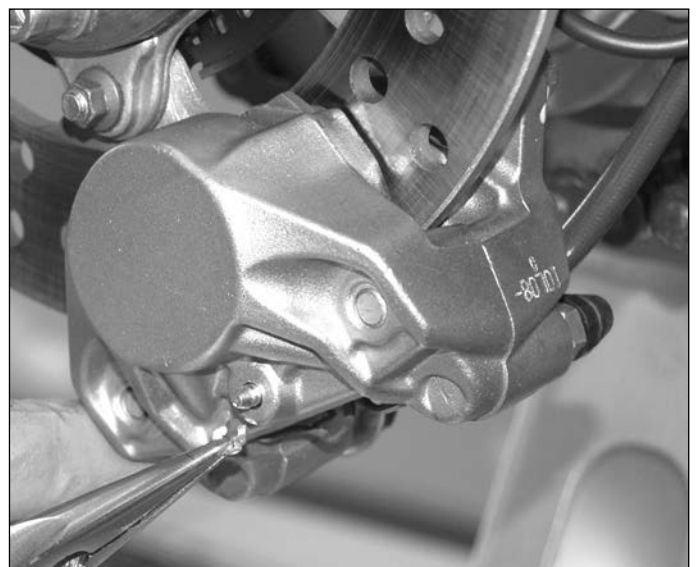

H



Brakes

Slide the pad supporting pin (1) off with a screwdriver until it comes out from the opposite side, freeing up the circlip as well (2).

Remove the pad (3) by letting it drop down.

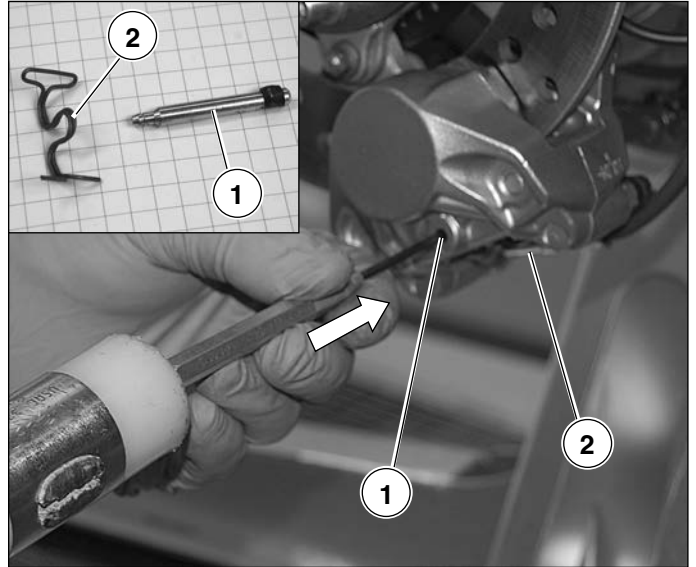

Remove the caliper from the support by removing the 2 fixing screws.

Remove the brake pads.

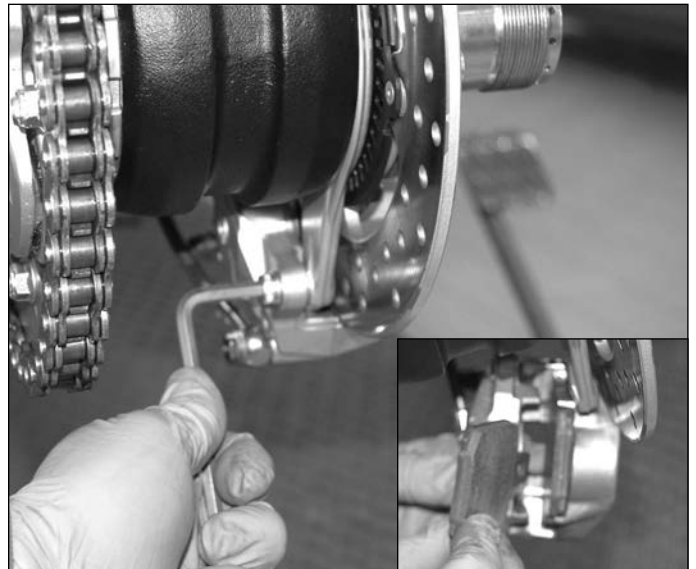

Carry out the check every 6000 kilometres.

Check the condition of the rear braking system and its components.

Proceed with re-assembly following the operations for disassembly in reverse order.

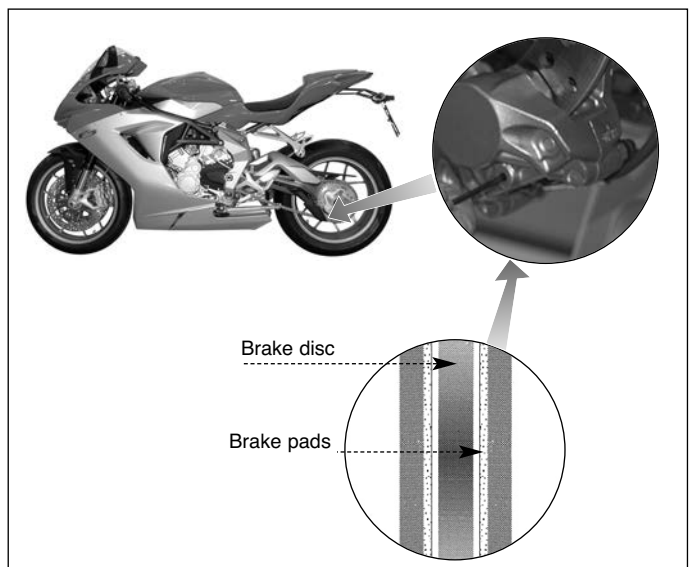



Brakes

SUBSTITUTION AND BLEEDING OF THE REAR BRAKE FLUID



The operation described herewith must be carried out with the engine cold because of the nearness of the exhaust tubes that could cause grave burns.

To carry out this operation it is necessary to remove the tank (1) along with the supporting bracket (2) from the frame plate, and then detach it from the bracket.

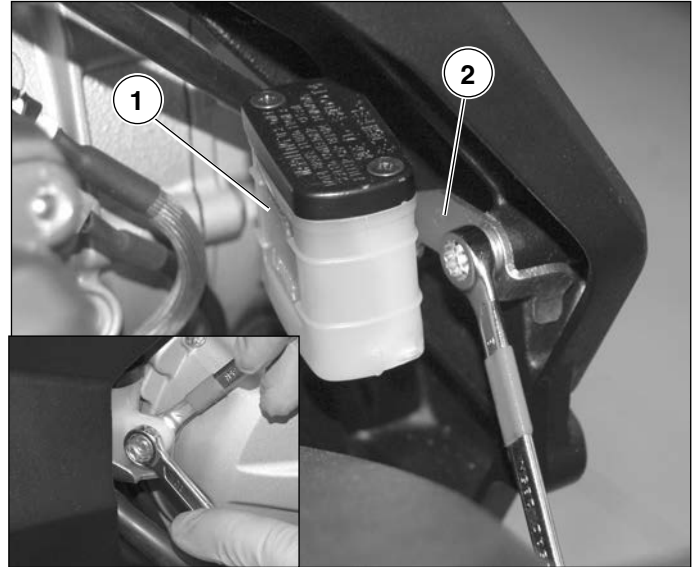

Open the cover of the rear brake fluid reservoir by removing the two screws (3).

Position the tank using a clamp and a protective cloth, and fasten it to the plate of the frame.

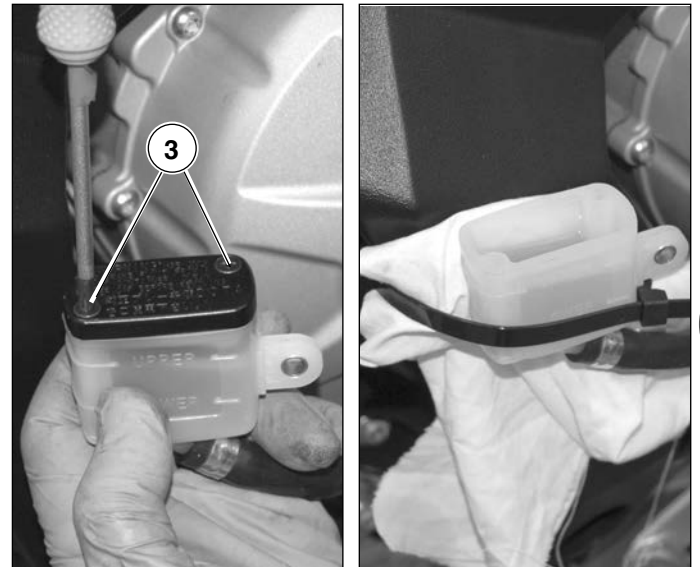

Be careful to not spill the fluid from the reservoir during these operations. Brake fluid is extremely corrosive. Avoid contact with the eyes, skin and nose. Wash abundantly with water if contact is accidentally made and consult a doctor. During the successive operations, avoid spilling the fluid onto painted surfaces.

Fill the braking system by operating the rear brake lever.



H



Brakes

Connect a rubber tube to the bleed valve, empty the system in an appropriate container by slackening the bleed valve as shown in the figure



Be careful not to let the liquid fall below the minimum level before topping it up with new brake oil, to avoid getting air into the system.



Tighten the fitting as described above. Fill the rear brake fluid reservoir until the fluid reaches the maximum level.



Brake fluid : AGIP Brake 4



Utilise exclusively the prescribed brake fluid. Use only new brake fluid from sealed containers. NEVER utilise old or used brake fluid.



Carefully clean around the edge of the brake fluid tank using a clean cloth.

Before closing the fluid reservoir, check the condition of the components.

Carry out bleeding also on the front brakes (see the paragraph in this chapter).

During tank re-assembly apply the required torque pressure to the screw (1) that clamps the supporting bracket to the plate of the frame.



Torque pressure: 8÷10 N·m

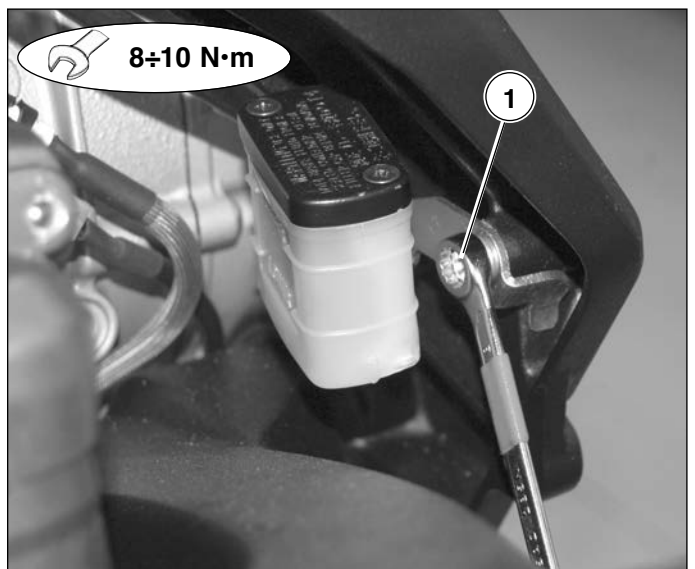



Brakes

REAR BRAKE CALIPER SUBSTITUTION

To facilitate the operation, remove the brake pads as described previously.

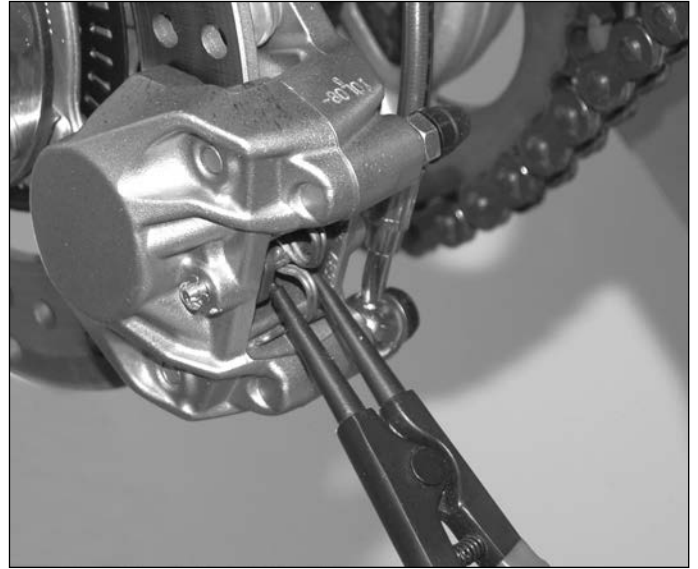

Empty the rear brake system as previously described in the paragraph "SUBSTITUTION AND BLEEDING OF THE REAR BRAKE FLUID".

Loosen the tubing by unscrewing the union indicated in the figure.

Pay attention to the fluid left in the caliper and the tube.

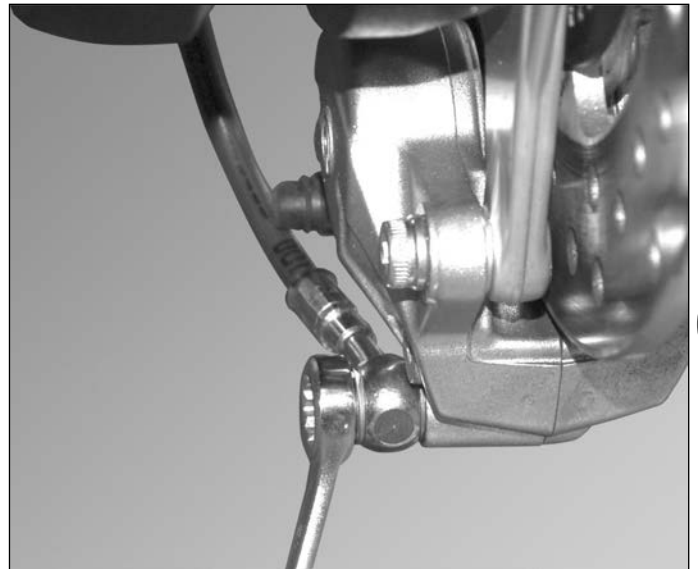

Remove the 2 screws shown in the figure and take off the caliper.

Substitute the caliper.

Remove the fitting to disconnect the caliper.

For caliper reassembly, tighten the two screws to the prescribed torque pressure.



**Recommended threadlocking product:
Loctite 243**



Torque pressure: 18 N·m

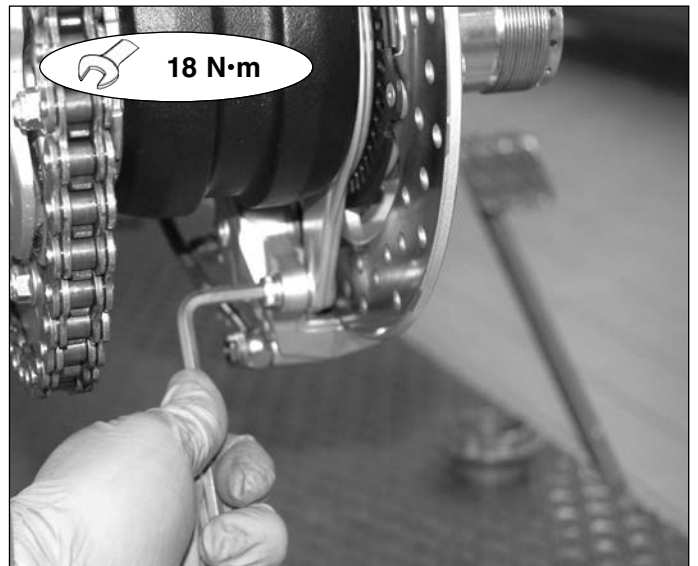

H



Brakes

Assemble the union tightening to the prescribed torque.



Torque pressure: $23 \div 26$ N·m

NOTE Substitute the gaskets with new ones.

Proceed with the filling and bleeding of the rear brake system (see page 25).

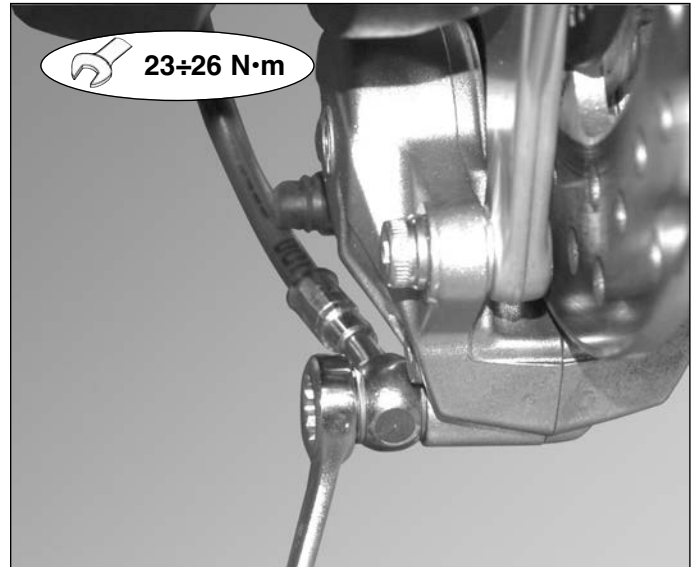

Rear brake pump removal

Carry out the emptying of the brake system as previously described.

Loosen the nut (1) and remove the clip with the pump control fork pin (2) by turning the pin and pulling it out (see figure).

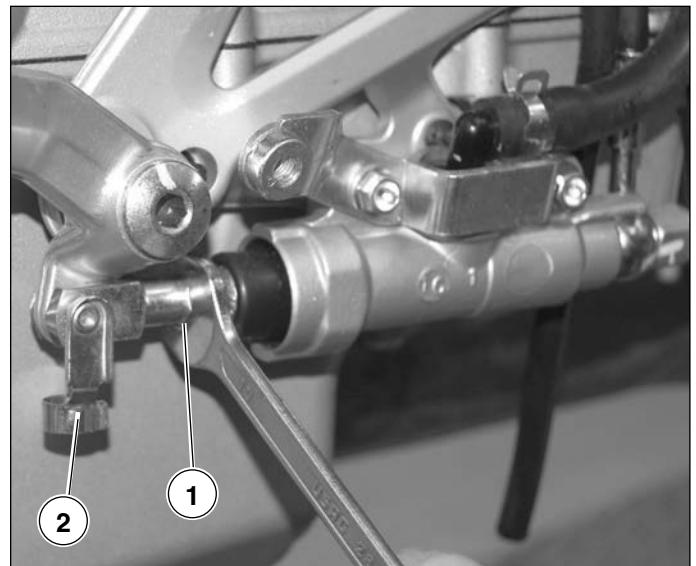

Disconnect the rear stop switch connector (1) once you have removed the clamp (2).

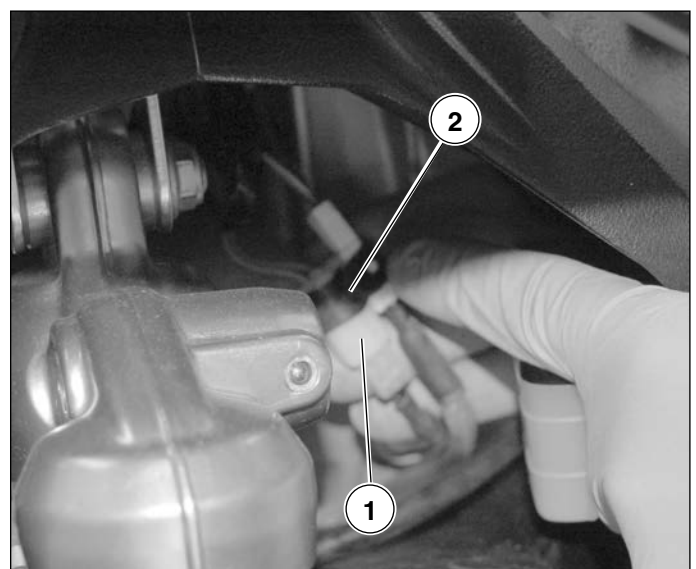



Brakes

Disengage the switch cabling by removing the two marked rubber clamps.



Unscrew connection (1) as shown in the figure so as to disengage the pump from the brake line.

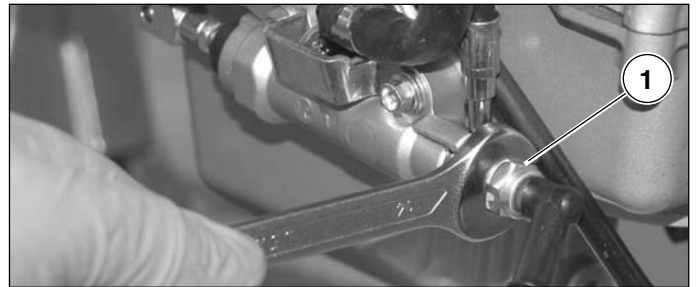

Loosen the retaining clamp by sliding it out of the work area and pull out the brake fluid pipe.

Unscrew the two fixing screws (2) of the brake pump to its relative support.

Take off the bottom fairing clamping plate (3).
Remove the pump.

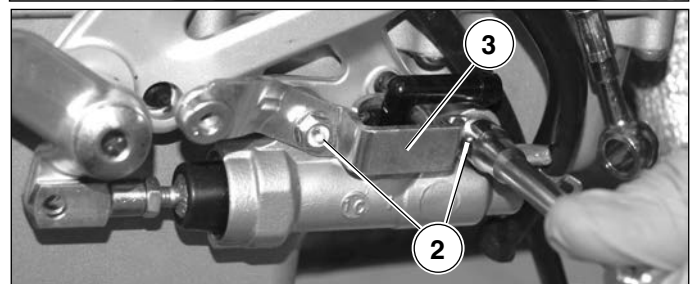

H



Brakes

After having carried out a check on all components and substituted those used, damaged or defective proceed with the assembly by following the procedure in reverse order of removal.

NOTE Substitute the gaskets of the pump/caliper hoses.

Tighten the fixings to the prescribed torque pressure.

 **Torque pressure pump union: 16÷18 N·m**

 **Torque pressure brake pump/support: 8÷10 N·m**

Conclude the operations by filling the system with brake fluid and successively bleeding the system (see page 25).

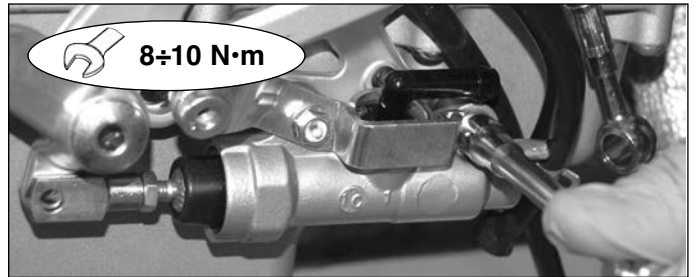
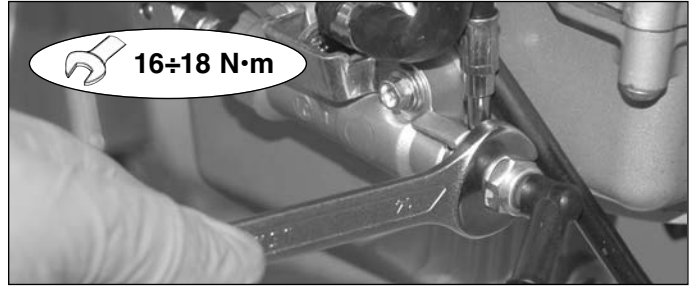

REAR BRAKE DISC

Check the thickness of the rear brake disc. Substitute the disc if the measurements are less than the minimum value allowed. Effectuate the substitution as hereby described.

- Minimum thickness allowed: 4,7 mm



REAR BRAKE DISC REMOVAL

Before proceeding with the removal of the rear brake disc, it is necessary to carry out certain operations described below:

- Remove the rear wheel.
- Remove the rear wheel pin from the motorcycle (See chapter F).
- Remove the phonic wheel.

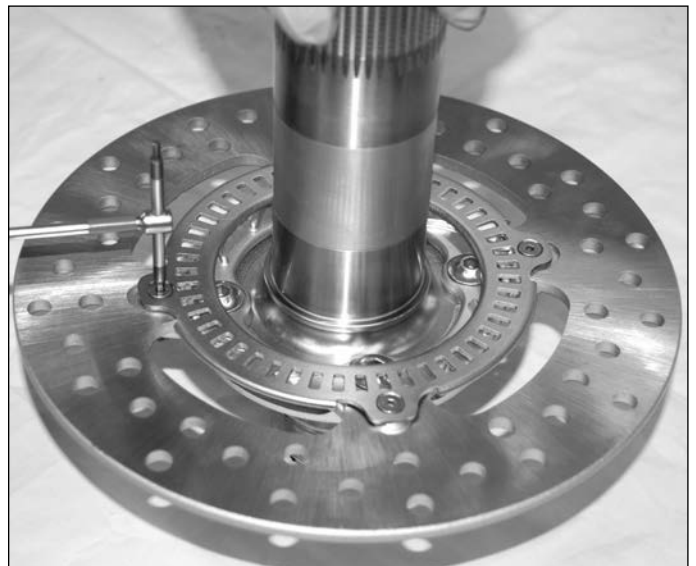

- Remove the four nuts fastening the disc to the flange.



Check the planarity of the rear brake disc by utilising a micrometer gauge and placing the disc on a level work surface. Utilise the same procedure adopted for the front wheel discs.

The planarity value must not exceed 0.3 mm.



Utilise a micrometer gauge with support to carry out this check.

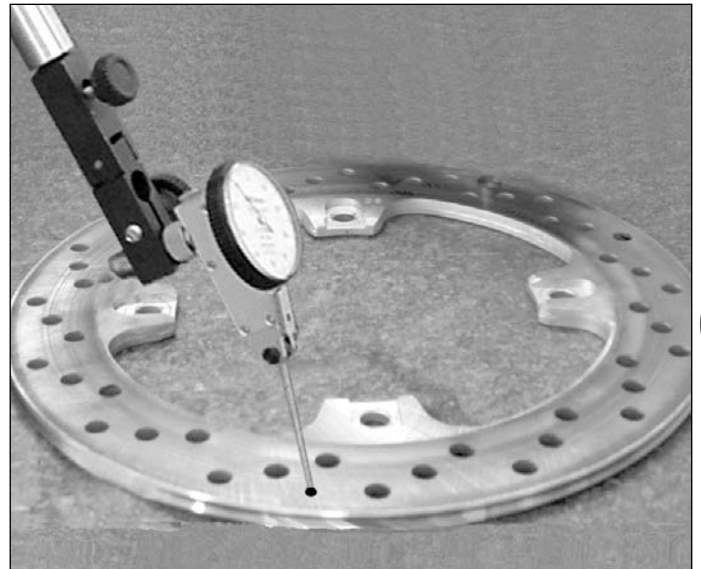

Check the thickness of the rear brake disc by utilising a micrometer gauge and measuring at least at three points with 120° between them.

The minimum thickness of the disc must not be less than 4,7 mm.



Utilise a micrometer gauge for this check.



H



Brakes

Before fitting the rear brake disc, check the condition of the four pins.

Replace the four special nuts with new ones.

Proceed with tightening of the nuts.

 **Turn in the nuts until they make contact, then tighten them in a crosswise pattern.**

 **Recommended threadlocking product: Loctite 270**

 **Torque pressure : 18÷20 N·m.**

Conclude the reassembly operations of the various components by following the procedures previously described in the chapter.

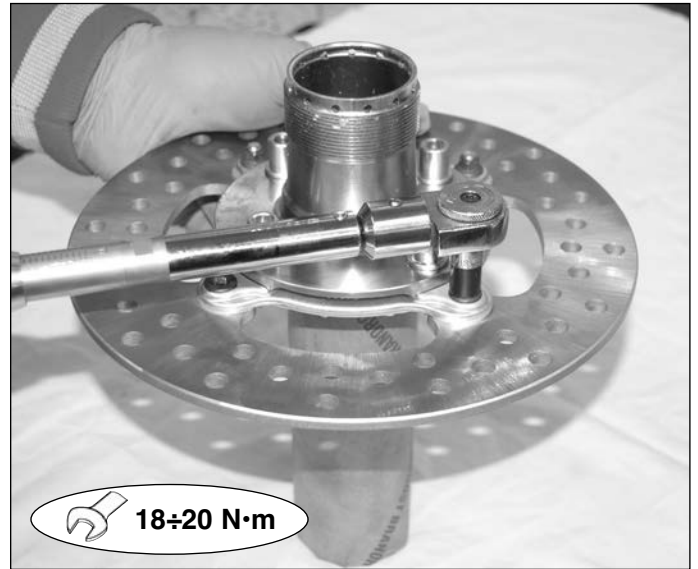

Use the following torque pressure when putting the phonic wheel back on:

 **Recommended threadlocking product: Loctite 243**

 **Torque pressure : 3 N·m.**

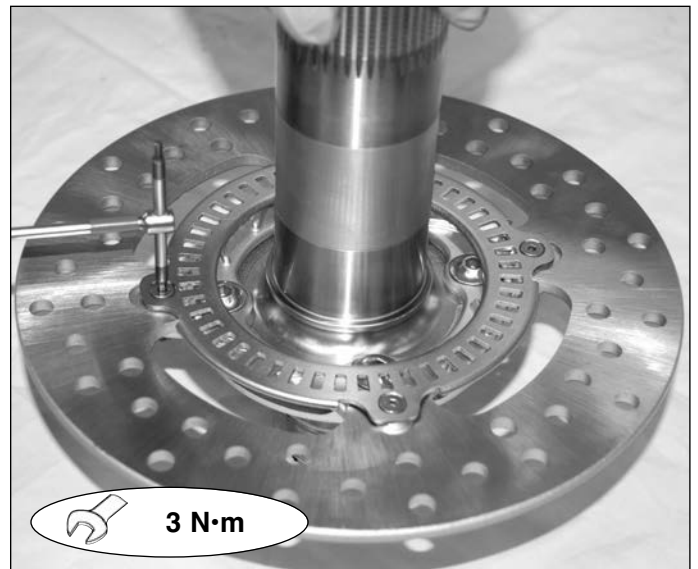



Cooling system

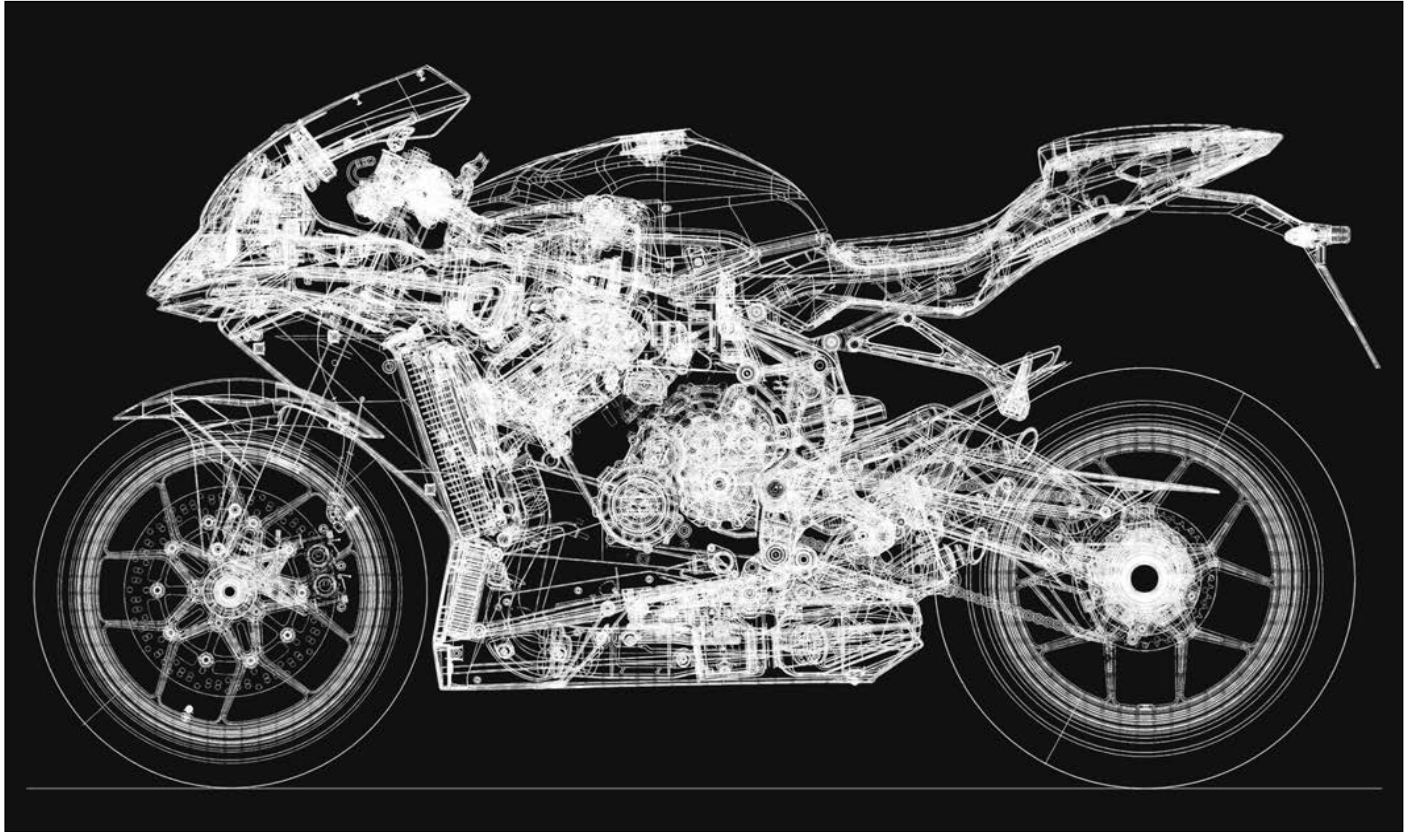

L

SECTION L
Revision 0



SUMMARY

COMPLETE COOLING SYSTEM ASSEMBLY	PAGE 3
COOLING SYSTEM LEAKAGE CHECK	PAGE 4
WATER RADIATOR CAP CHECK	PAGE 4
ENGINE COOLANT EXTRACTION	PAGE 5
WATER RADIATOR DISASSEMBLY	PAGE 6
DISASSEMBLY OF THE RECOVERY BASIN	PAGE 10
WATER RADIATOR COMPONENT DISASSEMBLY	PAGE 11
WATER RADIATOR COMPONENT ASSEMBLY	PAGE 16
THERMOSTATIC VALVE REMOVAL	PAGE 18
THERMOSTATIC VALVE ASSEMBLY	PAGE 20
WATER RADIATOR VEHICLE UNIT ASSEMBLY	PAGE 21
OIL RADIATOR DISASSEMBLY	PAGE 22
OIL RADIATOR COMPONENT DISASSEMBLY	PAGE 23
OIL RADIATOR ASSEMBLY	PAGE 25
FILLING THE COOLING SYSTEM	PAGE 27
MOTOR OIL SYSTEM FILLING	PAGE 28
SYSTEM FUNCTION VERIFICATION	PAGE 29

COMPLETE COOLING SYSTEM ASSEMBLY

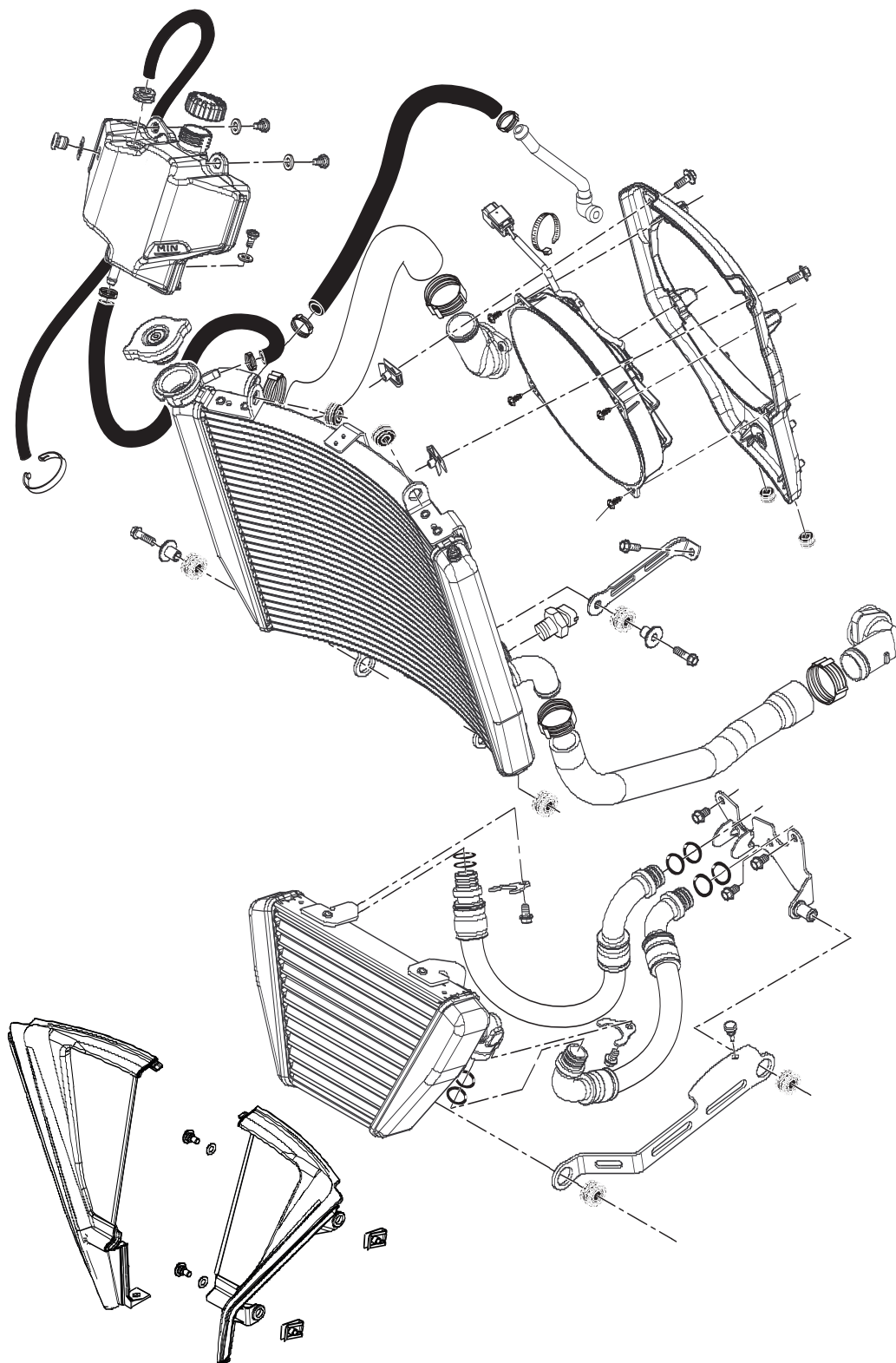

Before proceeding with the disposal or overhaul of any component relative to the cooling system, carry out certain preliminary operations:

- 1) Let the engine cool down.
- 2) Remove the side fairings, the underfairing, the fairings push rod, the headlight fairing, the suction duct covers and suction ducts as described in the chapter "Superstructures."



Cooling system

COOLING SYSTEM LEAKAGE CHECK

Before removing the radiator and discharging the engine coolant, check that the cooling system does not have leakages.

Remove the water radiator cap and connect the tester (of the type shown in the diagram) to the filler hole.

 **Do not open the radiator cap whilst the engine is hot.**

Apply a pressure of approximately 120 kPa (1.2 kg/cm²) and check that the system maintains the pressure for at least 10 seconds.

If the pressure diminishes within ten seconds means that there is a leak in the system.

If so, check the entire system and substitute the defective/damaged parts.

 **When removing the tester from the filler hole, wrap a cloth around the filler hole to avoid spurts of engine coolant.**

 **Do not exceed the recommended pressure to avoid damaging the radiator.**

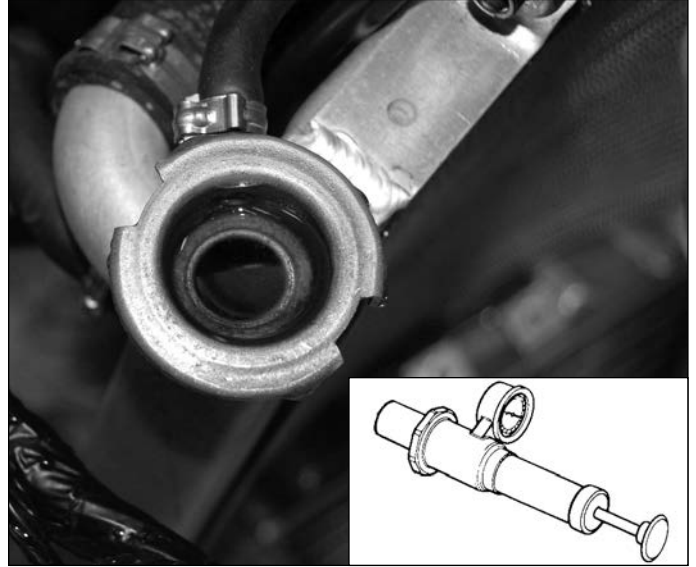

WATER RADIATOR CAP CHECK

Check the release pressure of the radiator cap by utilising the appropriate tester as follows:

Apply the cap to the tester as indicated and slowly create a pressure by activating the tester.

Make sure that the increase in pressure is interrupted at 110±15 kPa (1.1±0.15 kg/cm²) and check that with the tester held steady, the pressure is maintained for at least ten seconds. Substitute the cap if the pressure is not maintained for ten seconds.

Radiator cap release pressure: 110±15 kPa (1.1±0.15 kg/cm²).

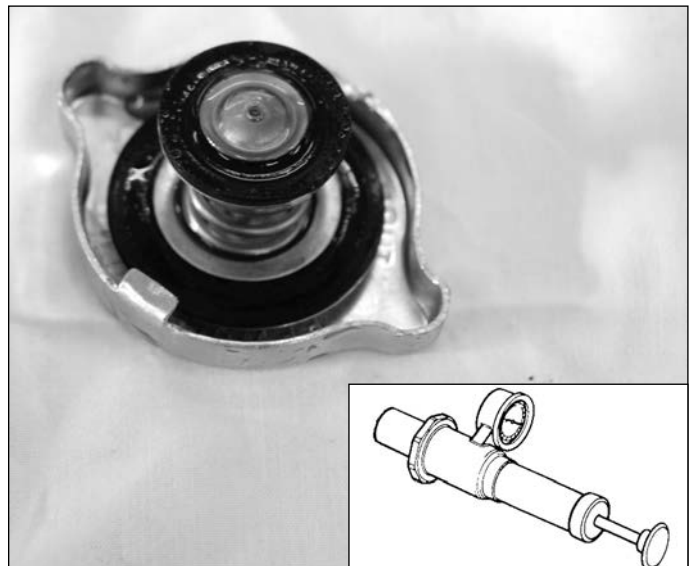



Cooling system

ENGINE COOLANT EXTRACTION

Remove the water radiator cap.

Empty the cooling system of the coolant as follows:

- Place under the engine a container to collect the discharged coolant.
- Remove the drain screw (1) situated on the engine.

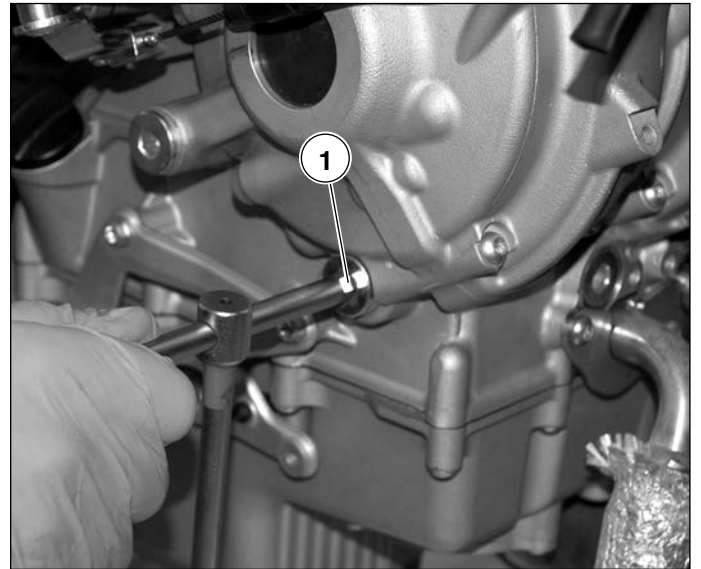

- Take off the radiator cap;
- Make sure the coolant flows into the container.

Wait until all the engine coolant has dripped out of the cooling system.

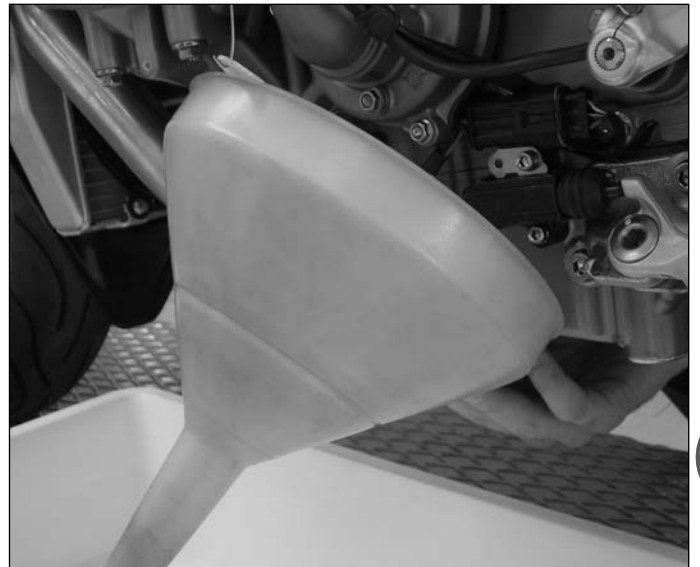

L



Cooling system

WATER RADIATOR DISASSEMBLY

After having emptied the cooling system, proceed as follows to remove the radiator:

- Remove the system retaining clamp.
- Disconnect the connector of the water radiator electric fan of the right side of the motorcycle.
- Disconnect the water temperature sensor connector from the left side of the motorcycle.





Cooling system

- Disconnect the 4 retaining radiator pipe clic clamps. One clamp is located on the left side of the vehicle.



The other 3 clic clamps are located on the right side of the vehicle.

- Disconnect the 4 pipes to drain away any fluid remaining in the basin

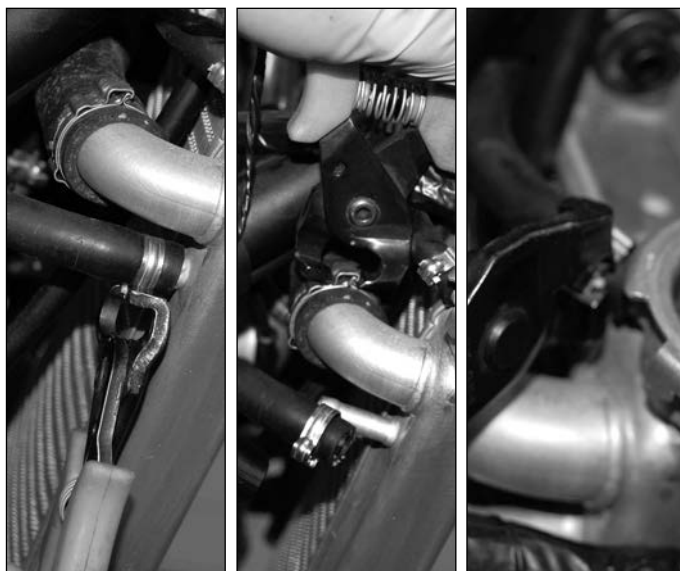

- Take off the screw on the right side that clamps the water radiator to the oil radiator.





Cooling system

- Disengage the oil radiator from the pin as shown.



- Pull the oil radiator towards the right and disengage it from the supporting pin. Leave it hanging from the engine by its pipes.



- Take off the bottom central water radiator clamping screw.





Cooling system

- Take off the top right side water radiator clamping screw.



- Lower the left side of the radiator and push it towards the right to slide it out from the top supporting peg.



- Pull the radiator out from the left side, turning it as shown in the figure.



L



Cooling system

- If necessary replace the bottom water connecting pipe, remove the clic clamp at the end of the radiator loading pipe on the left side of the motorcycle.

 **Special tool: CLIC 205 pincers**

- Remove the pipe.
Before carrying out this operation place a collecting container under the engine to collect any residual liquid.

NOTE Carry out the said operations with care. Pour the remaining coolant inside the radiator into an appropriate container.

 **Do not dispose of engine coolant in the environment. Collect in an appropriate container and dispose of it according the norms in force.**



DISASSEMBLY OF THE RECOVERY BASIN

Unscrew the three screws that clamp the recovery basin to the frame.

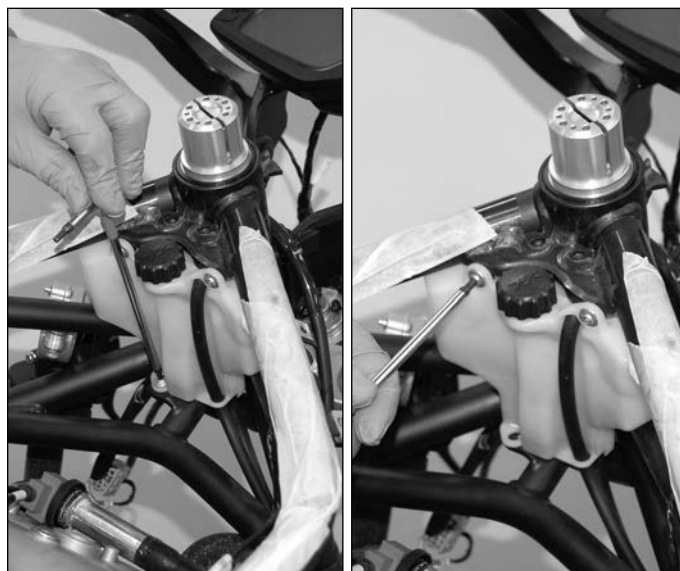

Remove the basin from the frame.





Cooling system

The basin includes a cap, a relief pipe and a connecting pipe to the previously-assembled water radiator.

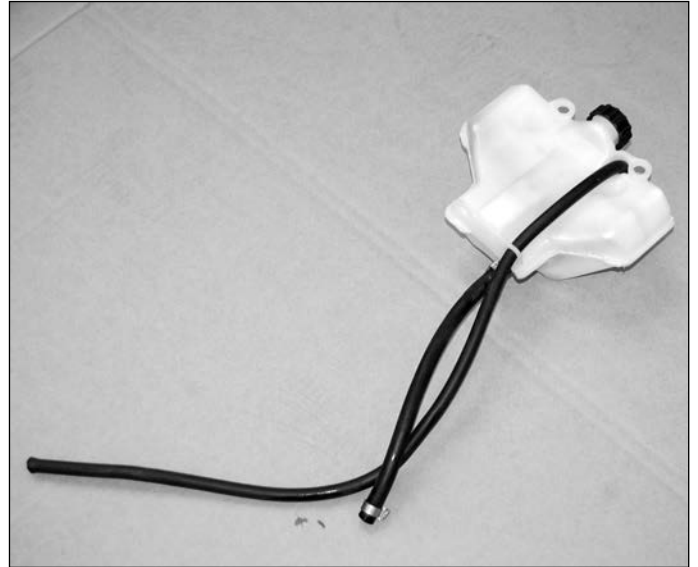

DISASSEMBLY OF THE WATER RADIATOR PARTS

Disassembly of the electric fan

Remove the 2 screws that clamp the conveyor to the radiator..

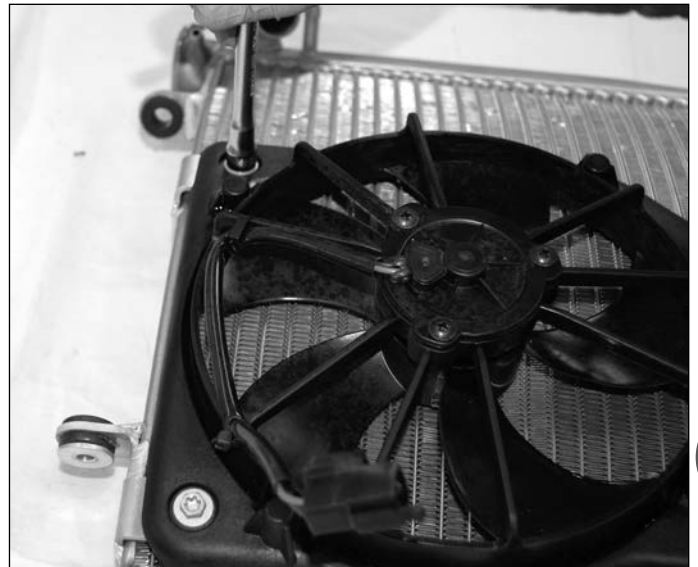

Lift the conveyor and slide it from the retaining pins.





Cooling system

Turn the conveyor by 180° and unscrew the 4 screws that clamp the fan to the conveyor.



Disassembly of the radiator clamping elements



Slide off the 2 threaded circlips.

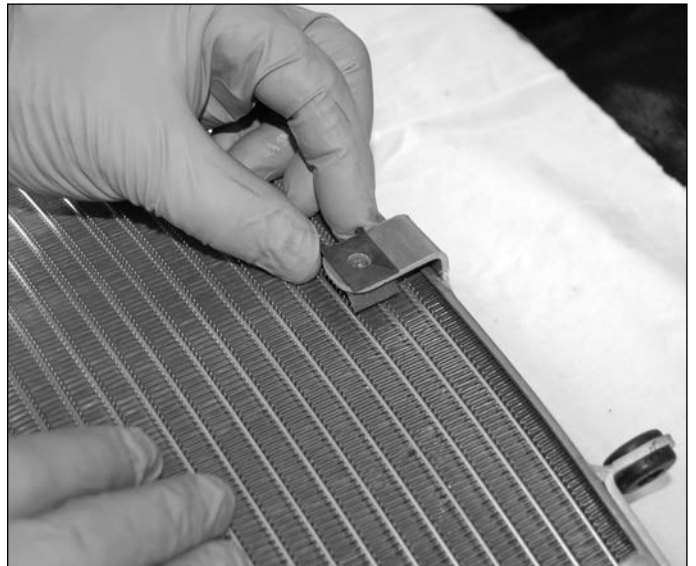



Cooling system

Slide the 2 spacers off of the bottom supporting brackets.



Remove the anti-vibration elements from the 3 bottom clamping brackets.

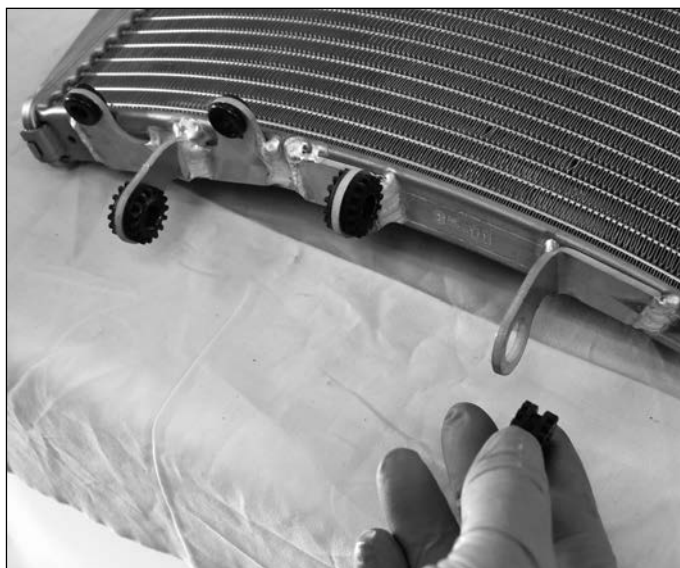

Remove the 2 anti-vibration elements from the air conveyor bracket.

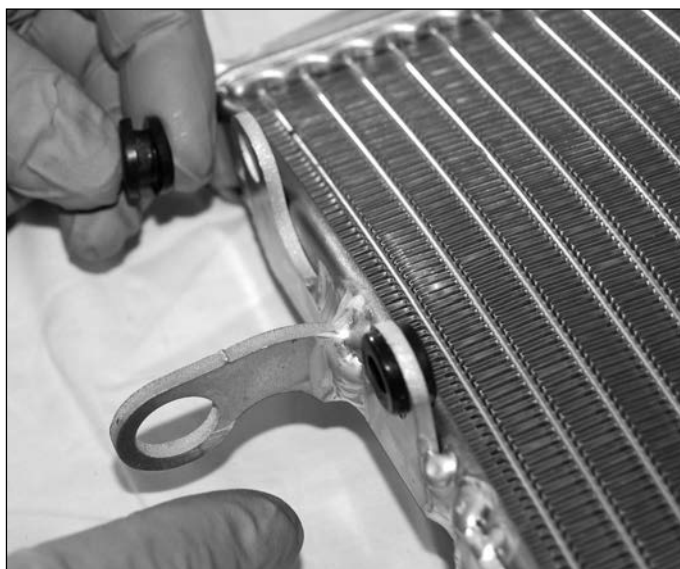



Cooling system

Slide the spacer off of the top left supporting bracket.



Slide the anti-vibration elements off of the 2 top supporting brackets.

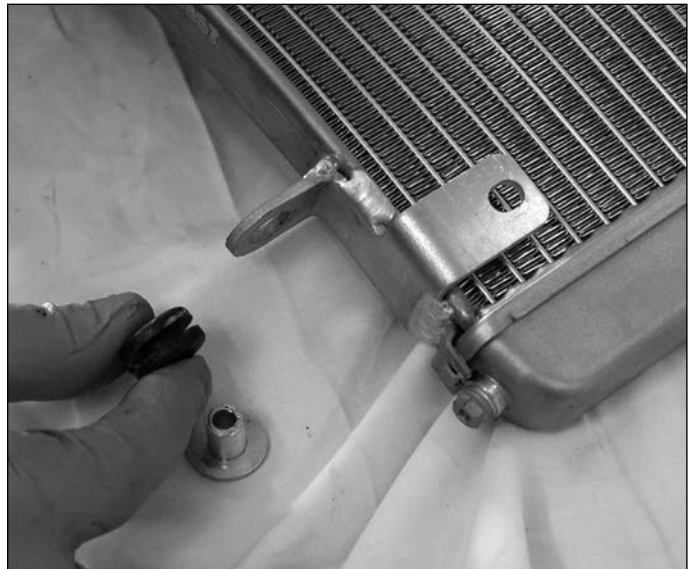

Disassembly of the liquid temperature sensor

Whenever it is necessary to check whether the liquid temperature sensor is operating efficiently proceed as described below.

Disconnect the electric connector indicated in the figure.

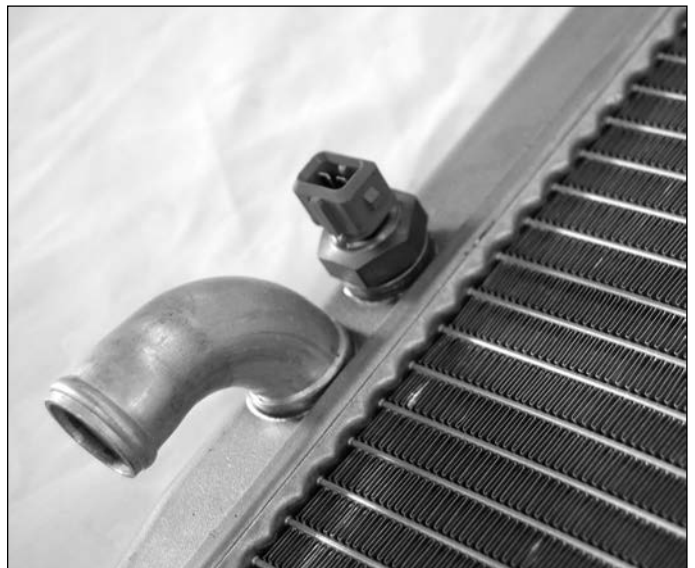



Cooling system

Remove the coolant liquid temperature sensor.



Check

Check that the resistance of the coolant liquid temperature sensor varies with the temperature, as specified. Carry out the control in accordance with the instructions below:

connect the coolant liquid temperature sensor to an ohmmeter and immerse it in the oil contained in a heated recipient;

heat the oil so as to slowly increase the temperature and observe the readings provided by the thermometer and ohmmeter. If the resistance of the coolant liquid temperature sensor does not change as indicated in the table, the sensor must be replaced.



Special tool 09900-25008: Multitester

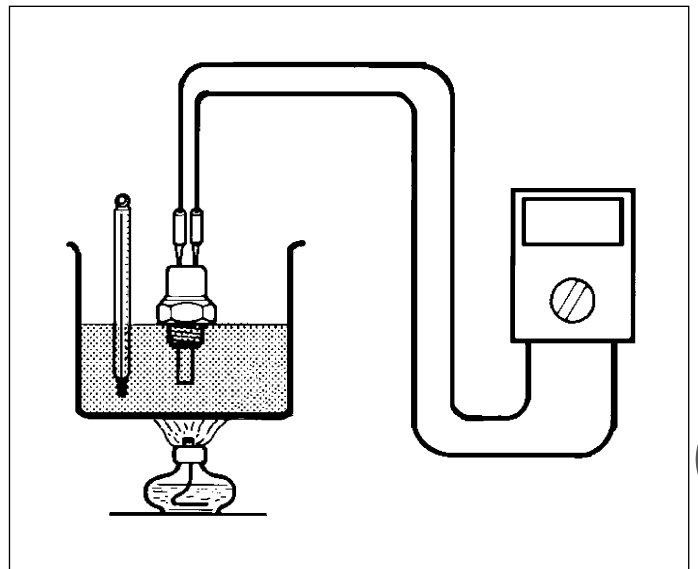

Temperature	Resistance standard
20 °C	About 3,747 Kohm
50 °C	About 1,150 Kohm
80 °C	About 0,377 Kohm
110 °C	About 0,153 Kohm
125 °C	About 0,102 Kohm

If the resistance is infinite or nevertheless differs considerably from the indicated value, the coolant liquid temperature sensor must be replaced.



Cooling system

Assembly of the liquid temperature sensor

Before assembly apply the stated type of threadlocker fluid to the threaded section of the sensor.



Types of applicable threadlocker: Loctite 577

Tighten the coolant liquid temperature sensor to the specified torque pressure.



Torque pressure for the coolant temperature sensor: 18 N·m



Be very careful when inserting the coolant liquid temperature sensor. It can be damaged if subject to impact.

Make sure that once it has been tightened the container is set up along a horizontal axis, with the rear stud set up in the vertical or horizontal position closest to the torque condition.

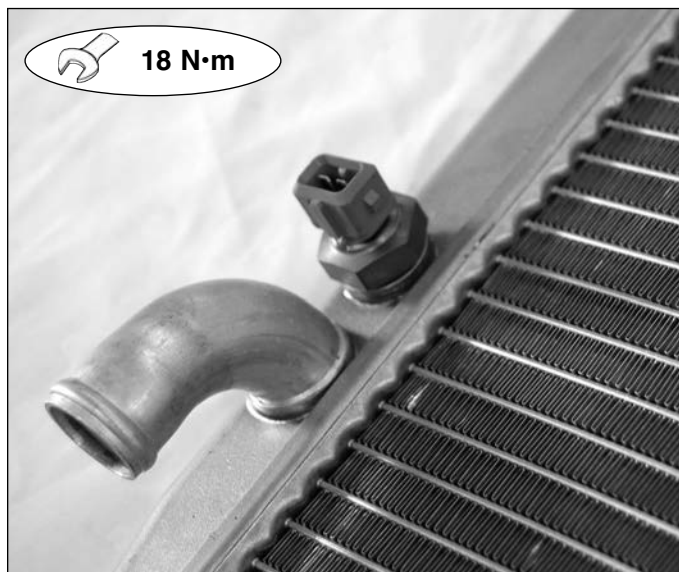

WATER RADIATOR GROUP ASSEMBLY

Before reassembling, check the correct rotation of the fan, the condition of all components and all connections.

Radiator check and clean

The dirt and extraneous material embedded in the radiators must be removed.

It is recommended to use compressed air for the cleaning of the radiator.

L Bent fins can be straightened by utilising a small screwdriver.



Cooling fan motor check

To make sure that the electric fan motor is operating efficiently, it must be connected as shown in the figure, through a voltmeter and ammeter.

The motor must be powered for the test.

This test can be carried out on a work surface (connecting a 12V-9Ah battery) or on board the motorcycle.

The voltmeter is to check that the battery feeds the motor at 12V. When the fan turns at maximum speed the ammeter should indicate not more than $7 \div 8$ ampere.

If the motor does not turn, substitute the fan motor with a new one.

NOTE To carry out the above-indicated test it is not necessary to remove the fan motors from the vehicle.

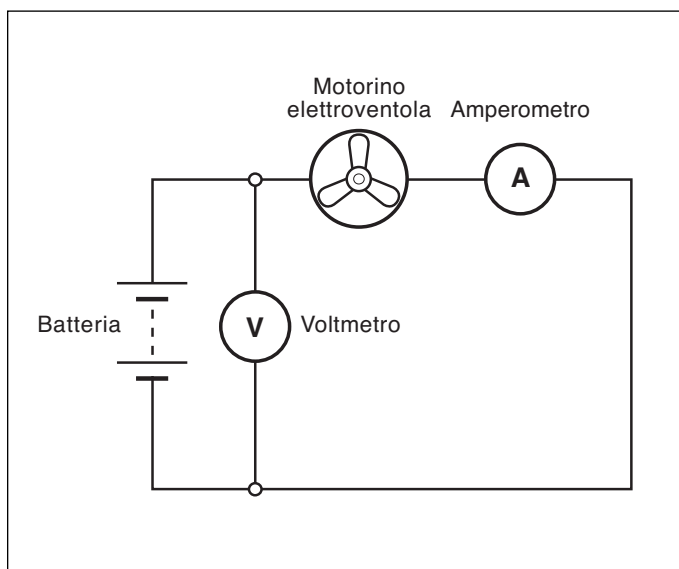

Position the electric fan on the radiator.
Position electric fan wiring as indicated in the figure.

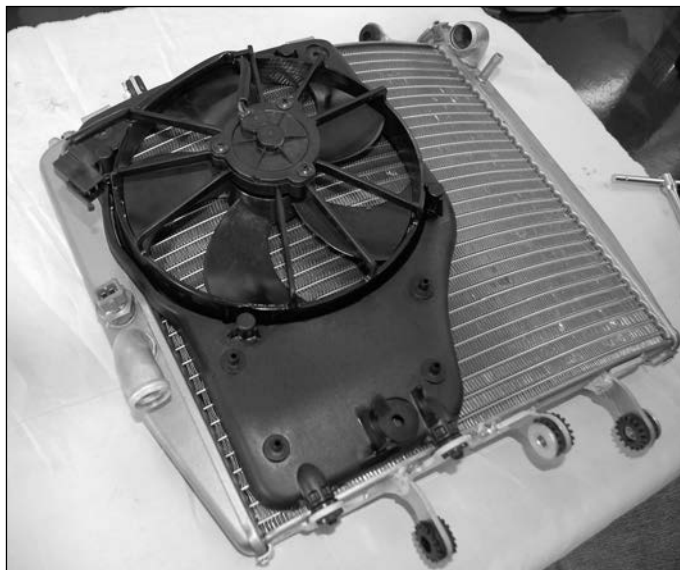

Tighten the 2 screws to the prescribed tightening torque.



Torque pressure: 5 ÷ 6 N·m

Replace the previously removed components following the disassembly procedures inversely.



The assembly of the new radiator group has been completed.

At the end of the assembly operation, the radiator group should look like the group indicated in the figure.

The radiator group can be mounted onto the motorcycle.





Cooling system

THERMOSTAT REMOVAL

Remove the 2 fixing screws of the thermostat cover.



Remove the cover of the thermostat (1).
Remove the thermostat (2).

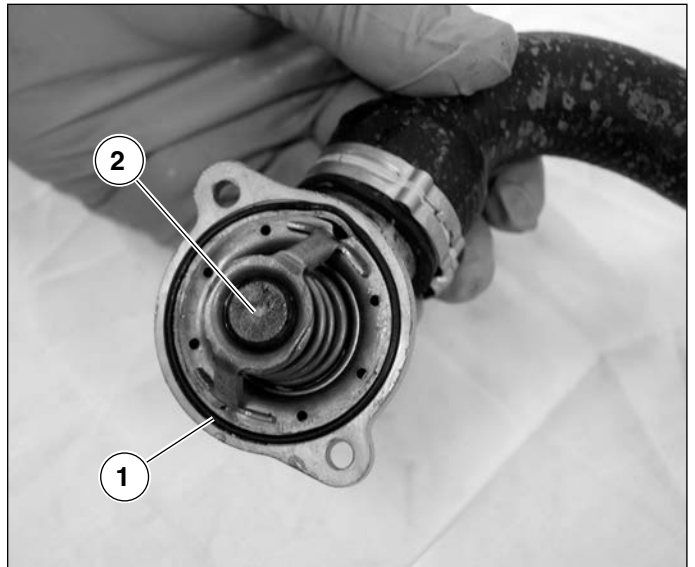

L



Cooling system

Check

Check to see if the thermostat pad is damaged.

Check the functioning of the thermostat as follows:

- Suspend the thermostat by a piece of string threaded through the flange as indicated in the figure.
- Immerse the thermostat in water contained in a laboratory glass as indicated in the figure. Ensure that the thermostat is maintained in suspension. Heat the water with a heat source and observe the increase in temperature of the thermometer.
- Observe the temperature at the moment of opening of the thermostat. The temperature at which the thermostat commences to open should be between the indicated values.

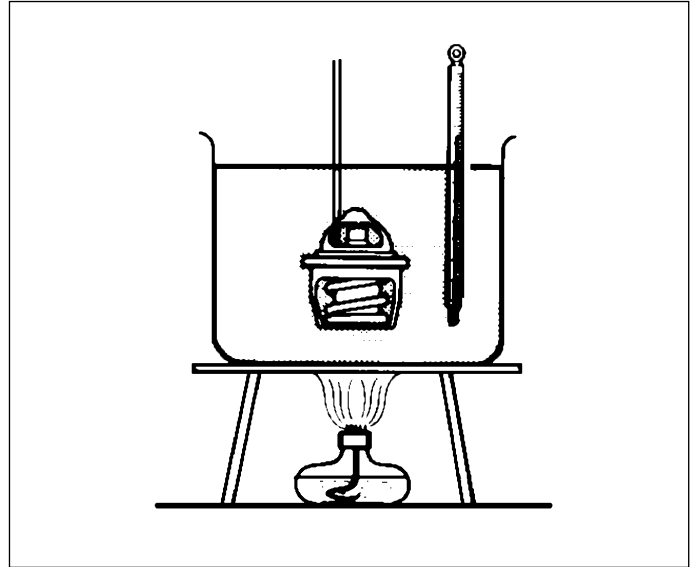

Standard

**Thermostat opening temperature:
60°C**

- Continue to heat the water to increase the temperature.
- When the temperature of the water reaches the specified value, the thermostat should be raised up by at least 7 mm.

Standard

**Raising up of the thermostat:
More than 7.0 mm at 90°C.**

- If the thermostat does not satisfy only one of the requisites (opening temperature and raising up of the thermostat), it must be substituted.



Cooling system

THERMOSTAT ASSEMBLY

Insert the O-ring (1) in its appropriate seat on the cover of the thermostat.
Check the condition of the O-ring previously utilised.



If the O-ring is not in good condition, substitute it with a new one.

Apply a thin layer of silicone grease.



Recommended grease: Silicone Grease.

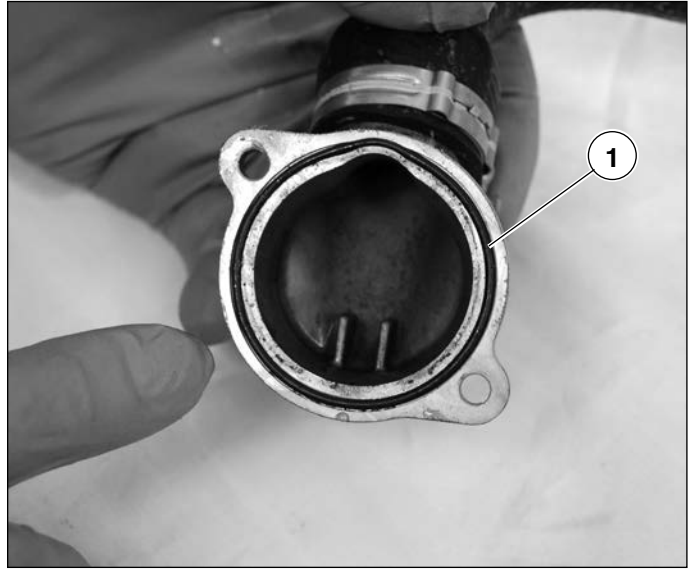

Apply grease on the outer flange of the thermostatic valve on the inlet side of the engine.



Insert the thermostatic valve in its housing on the engine.
During thermostatic valve assembly, ensure that the notch (2) present on the outer flange of the valve is positioned near the machining (3) on the engine.

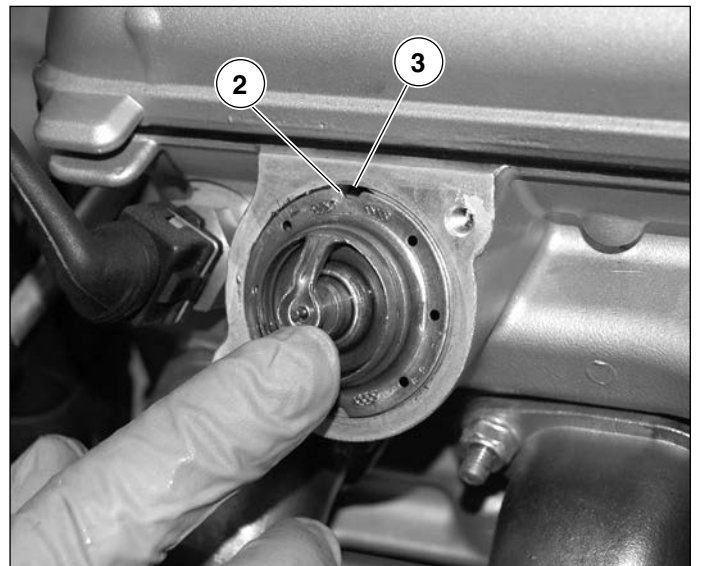



Cooling system

Insert the thermostat cover on the engine.

Tighten the 2 fixing screws to the prescribed torque pressure.

 **Torque pressure: 8 N·m**

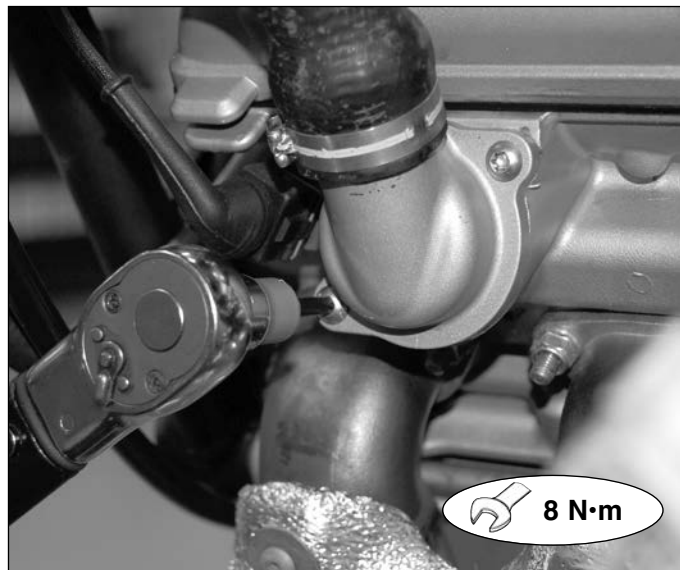

WATER RADIATOR VEHICLE UNIT ASSEMBLY

Reassemble the radiator unit in the opposite order of disassembly.



L



Cooling system

OIL RADIATOR DISASSEMBLY

To disassemble the oil radiator with its pipes, it is also necessary to disassemble the water radiator and exhaust manifold beforehand.

Remove the 3 clamping screws for the pipe retaining plate and slide it off downwards.



Position an oil collecting basin under the pipes.

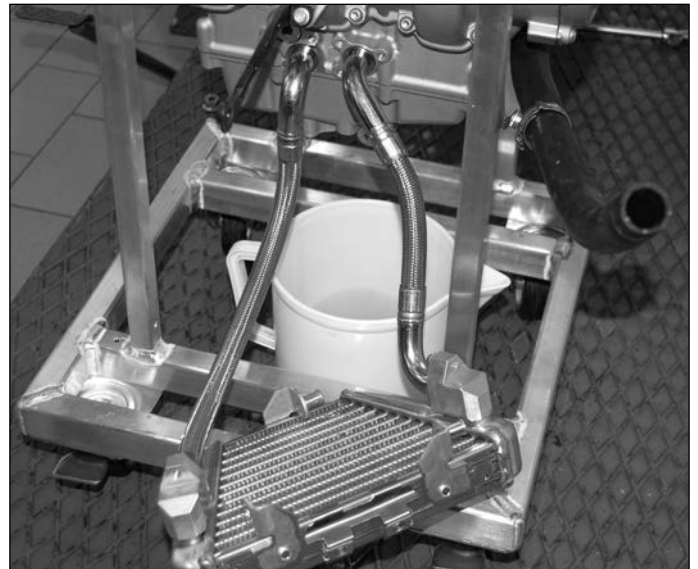

Slide the connecting pipes off one at a time from the engine base and let the residual oil flow out into the basin.

Remove the oil radiator.





Cooling system

Make sure the part is intact and of necessary straighten the folded flaps with a screwdriver.

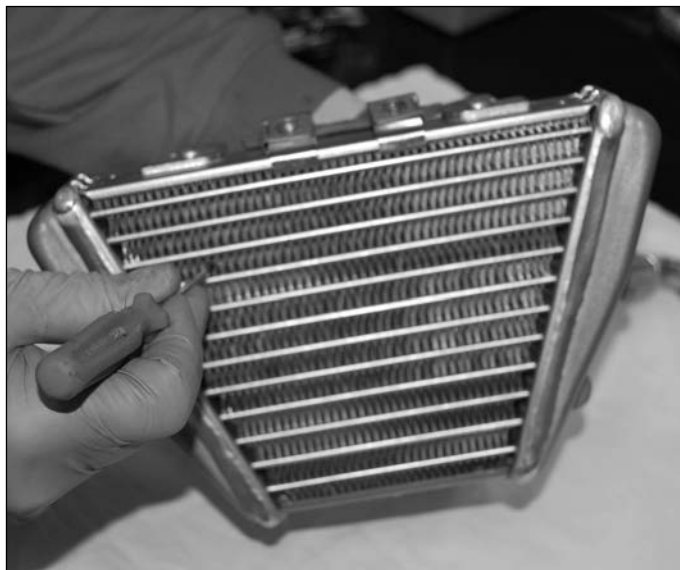

OIL RADIATOR COMPONENT DISASSEMBLY

Removing the connecting pipes

Take the retaining screw off of the plate.



Slide the pipe off.

Do the same with the other one.

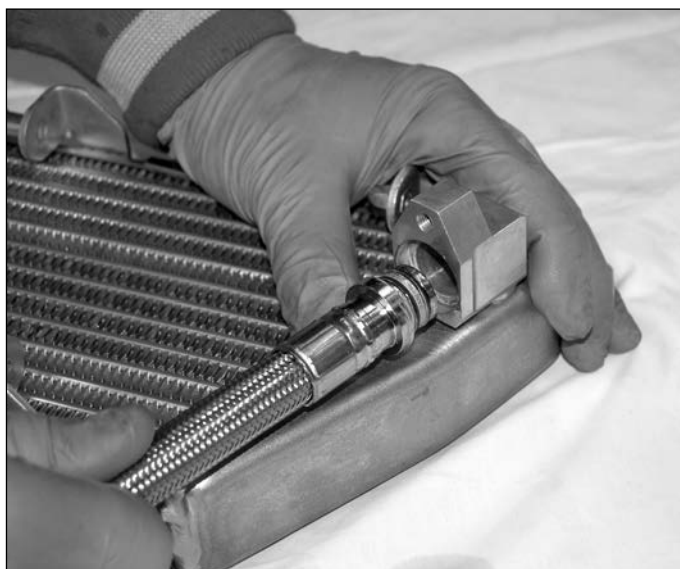



Cooling system

Removing the plate that fastens on the fairing tip
Lift and move the plate flaps away using a screwdriver.

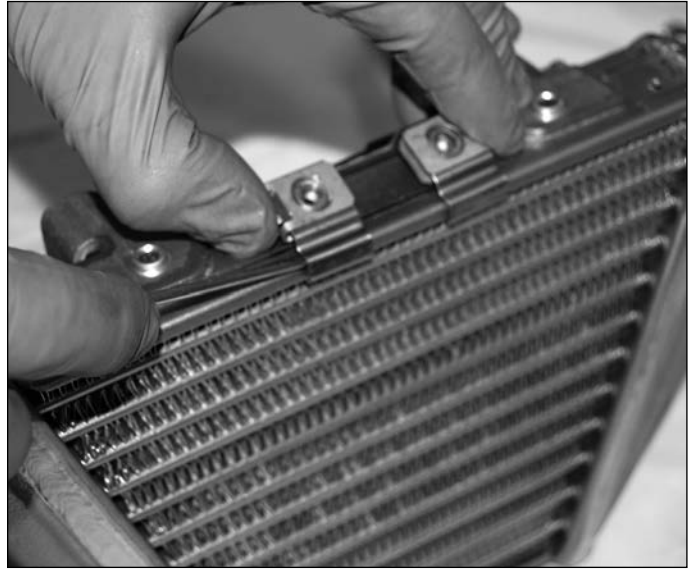

Remove the plate that fastens on the fairing tip.

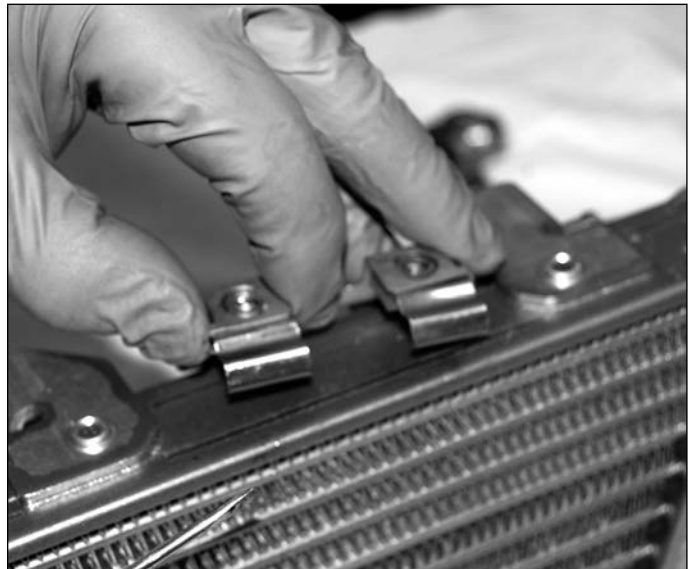

L



Cooling system

OIL RADIATOR ASSEMBLY

Before reassembly, check the integrity of the oil tubes and replace if necessary.

Change the sealing rings for the oil pipe fittings every time they are disassembled.

Grease O-rings with silicone grease.



Proceed to re-assemble the previously removed parts following the disassembly instructions in reverse order, being careful not to put the pipes in backwards, confusing right with left and one end with the other.

Observe the torque pressure of the screw that clamps the retaining plate to the oil radiator pipe.



When re-assembling the oil radiator pipes, keep the return pipe clamping screw slack (1).

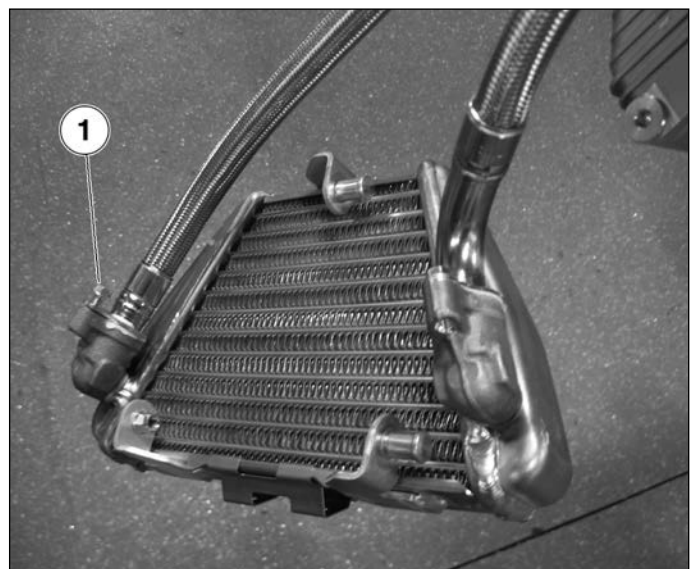



Cooling system

Put in and tighten the two clamping screws (2) for the return pipe plate first, then proceed to put in and tighten the screw (3) keeping the return pipe resting on its seat.

 **WARNING:** Do not turn the pipes once the screws have been tightened

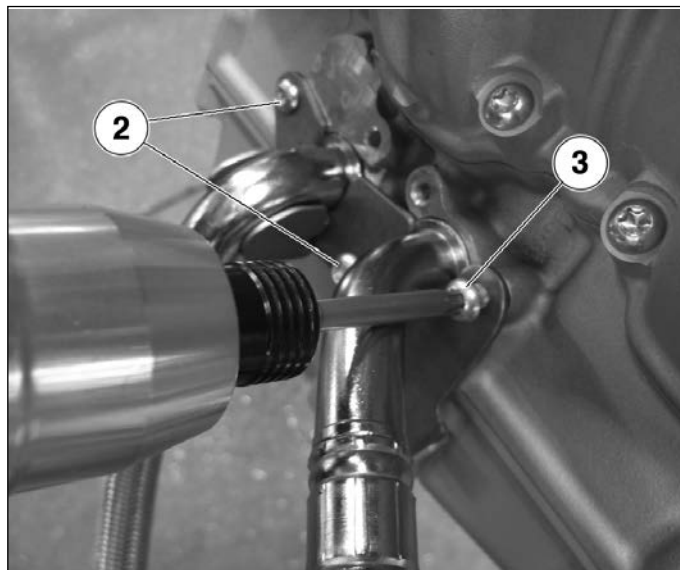

Once the screws have been tightened, make sure that the pipes are set up in the direction shown in the figure.

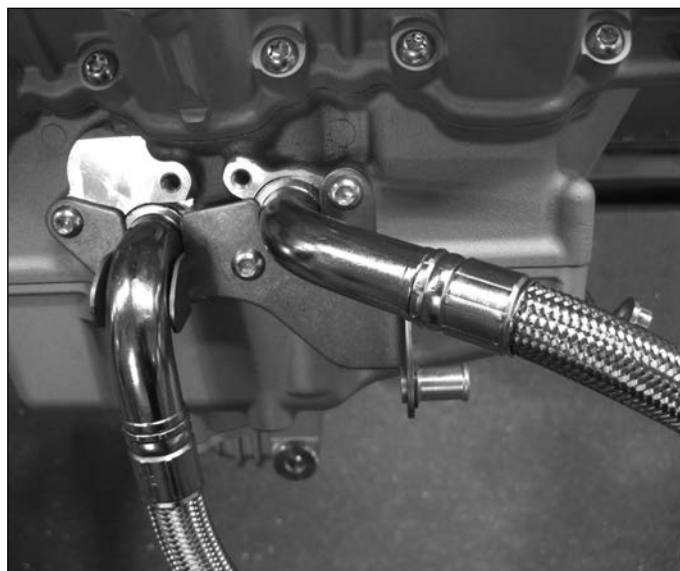

Test the oil radiator position based on the installation position on the motorcycle, with the aim of checking whether the pipes get bent in any way. If the pipes do not get bent in this position, tighten the screw for the return pipe (1) which was left slack at the beginning of the procedure.

To correct the position, loosen the screws on the fastening plate for the pipes to the engine, if it is necessary to correct the position of the pipes.

NOTE The radiators that have just been assembled must include the items shown in the diagram on page 3 of this chapter. Carry out a final control before continuing with the following operations. If you need to code and define the quantity of items, consult the parts catalogue.

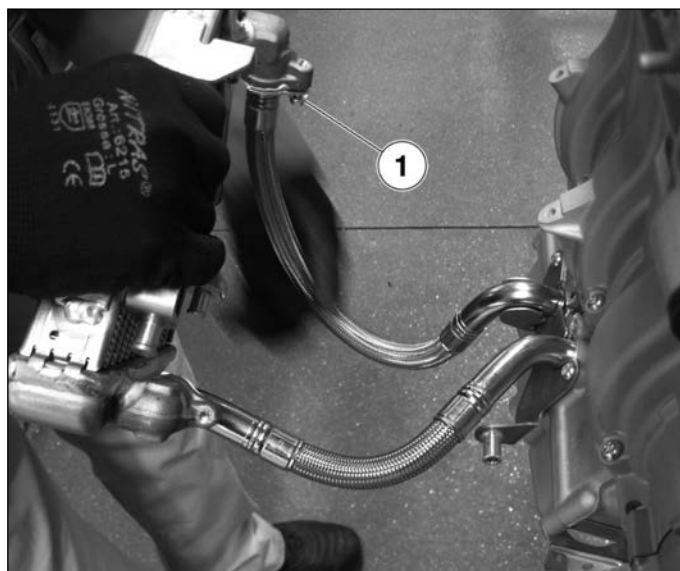



Cooling system

FILLING THE COOLING SYSTEM

Position the motorcycle on the side stand.

Fill the cooling system with the required liquid described in the table (see page B-8) up to the level of the radiator fill cap. Carry out the operation several times until the level of the liquid is stable.

Close the cap and bring the motorcycle back to a vertical position on the central stand.

Fill the expansion tank up to the "MIN" level.



Start the engine, keeping it running long enough to heat the fluid until the cooling fans begin operating, then turn the engine off. Repeat the operation at least once, then wait a few minutes for the engine to cool.



Check thoroughly for leaks, seepage, damaged pipes, etc in the cooling system. If necessary overhaul the system following the steps described in this chapter.



Check the coolant liquid level inside the expansion tank again. It must be above the "MIN" level marking on the expansion tank.

If the level is below the "MIN" mark, top it up by adding new liquid through the fill cap.

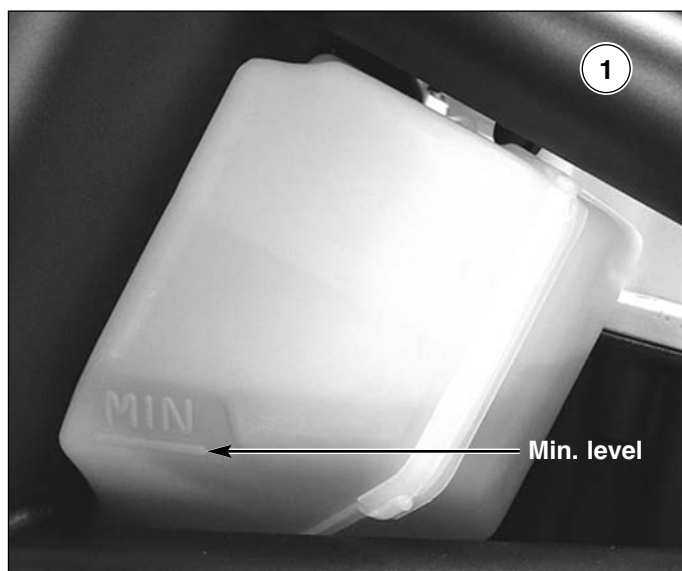



Cooling system

MOTOR OIL SYSTEM FILLING

Unscrew the oil fill cap.

Pour in the required quantity of oil.

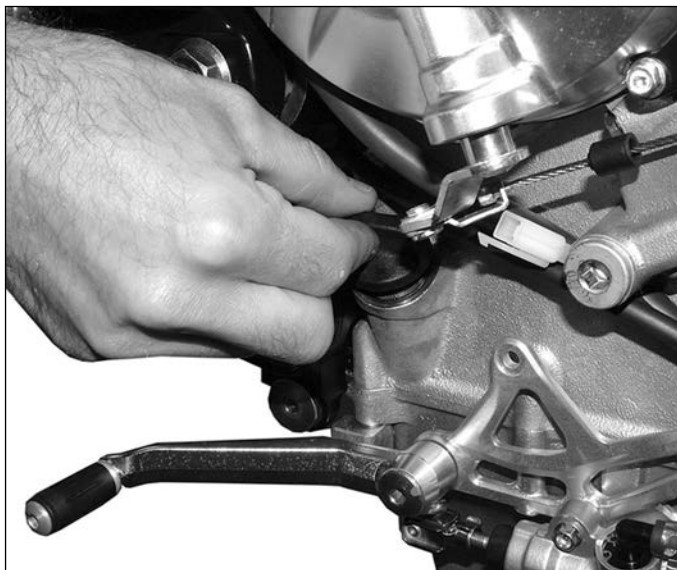

Make sure that the oil level is between the MIN and MAX level markings on the fill cap control rod.

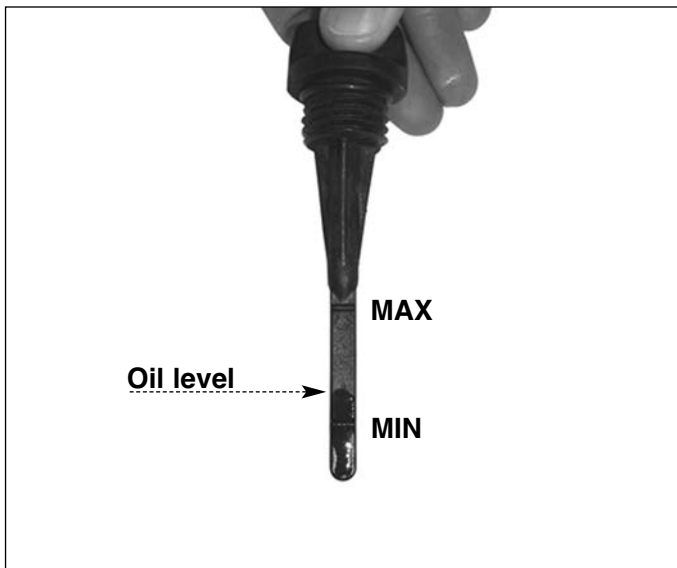

Before replacing the filler plug, grease O-ring (1) with silicone grease, then reinsert it into its seat (see figure).

Tighten the cap.

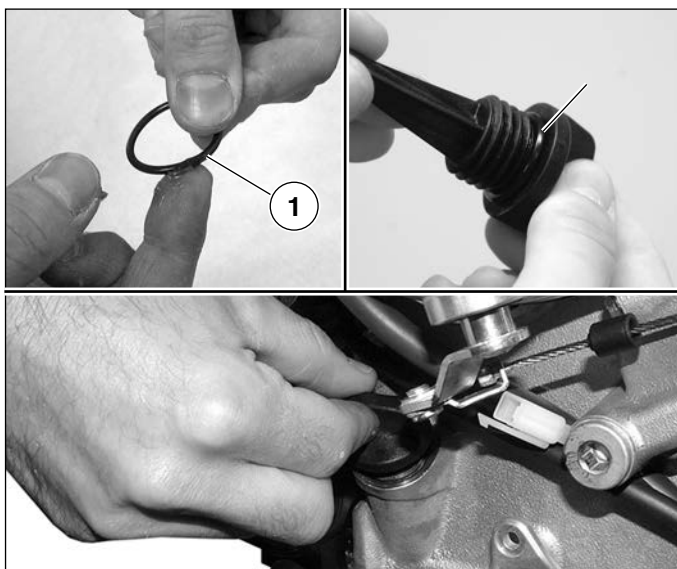



Cooling system

SYSTEM FUNCTIONING CHECK

Assemble the following components in order:

- Airbox.
- Fuel tank.
- Rear side panels.
- Fuel tank side panels.
- Air intake ducts.
- Front fairing.
- Left and right fairings.
- Under fairing.

For the assembly operations, assemble in reverse order of removal.

Cooling system

Insert the ignition key and start up the vehicle engine. Keep it running until it warms up and wait until fan enter into operation at least twice. Switch off the engine and wait for the temperature to cool down. Then do a final check of the cooling liquid level and top up if necessary.

Carefully check that there is no leakage from the cooling system or.

Motor oil system

Start the engine for some minutes.

After having shut off the engine, wait for at least 10 minutes and check the oil level. Ensure that the ground is flat and keep the motorcycle standing as much as possible.

The level must be near the “MAX” reference on the timing case as much as possible. Do not exceed this limit. Check any oil leakages.



Avoid making the engine turn with the oil level lower than the minimum level; this can impair the operation of the different parts of the engine.

If the oil level, after the reset, is upper than the “MAX” reference, correct it by emptying the system.

Complete the assembly of the motorcycle.





Cooling system

L



Special tools

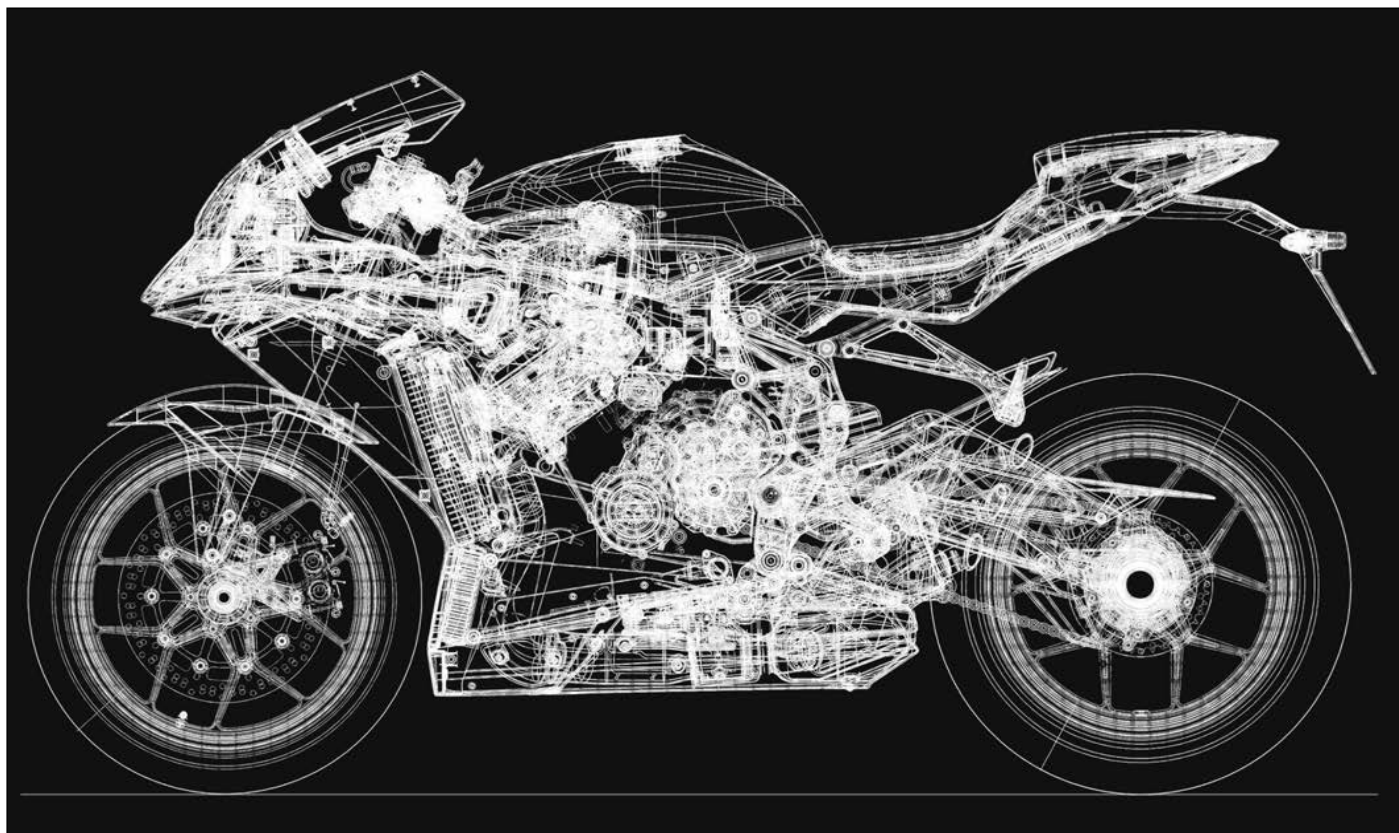

M

SECTION M

Revision 0



Special tools

MAINTENANCE TOOLS

The special tools shown in the following chapter are indispensable for a correct carrying out of the described maintenance operations.

To order the special tools, refer to the spare parts catalogue.

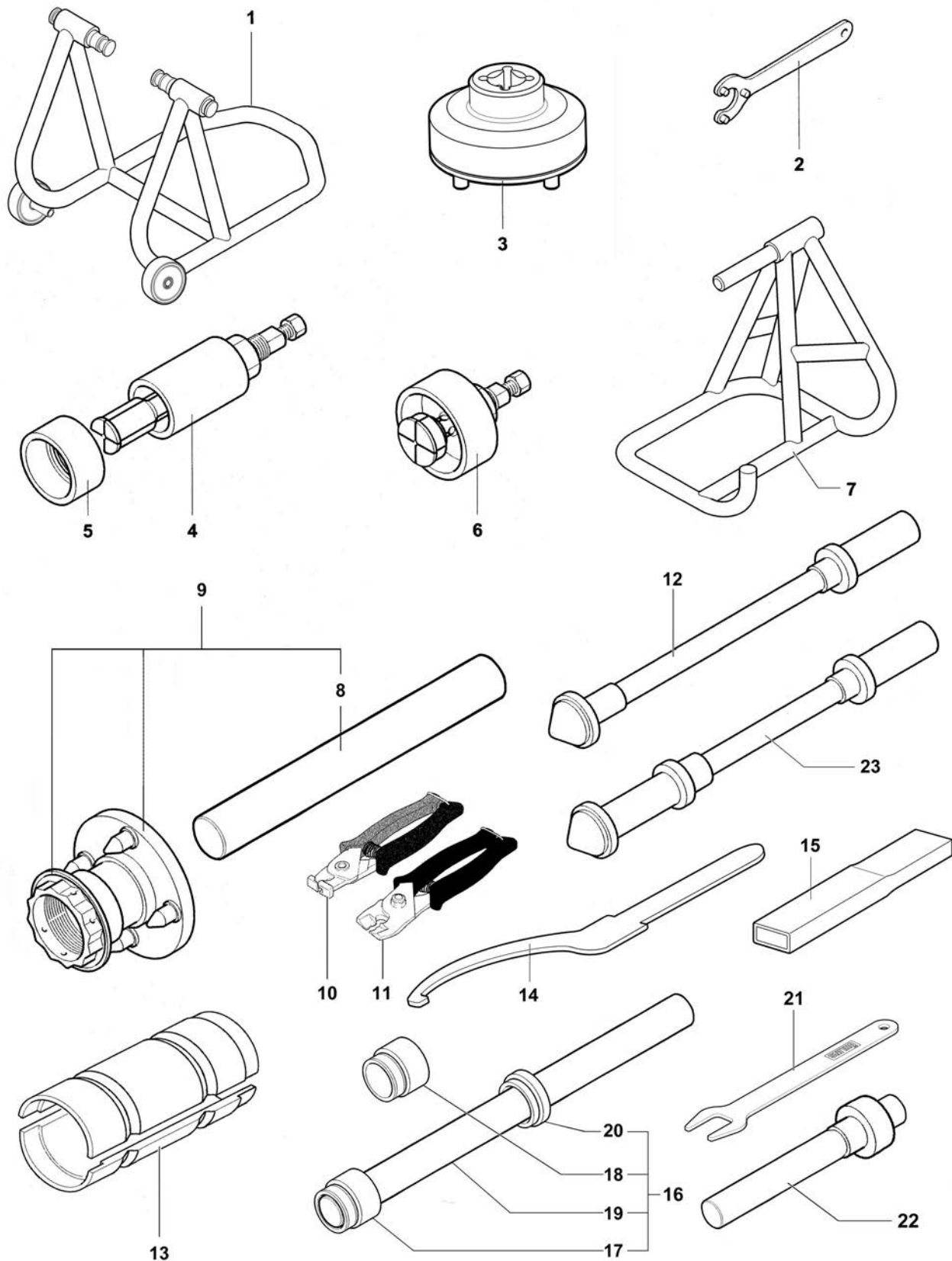



Special tools

N.	Code	Q.ty	Note	F3 675	F3 ORO	Descrizione	Description
1	800095830	2		•	•	Cavalletto anteriore	Front stand
2	800091645	1		•	•	Chiave ghiera cuscinetti di sterzo	Steering bearing pin wrench
3	8000B6876	1			•	Attrezzo per tappo superiore	Tool for fork cap
4	800092860	1		•	•	Estrattore cuscinetti forcellone	Fork bearings puller
5	800092861	1		•	•	Boccola estrattore cuscinetti forcellone	Fork bearing puller bushing
6	8000B4416	1		•	•	Estrattore cuscinetti ruota anteriore	Front wheel bearings puller
7	800092642	1		•	•	Cavalletto posteriore	Rear stand
8	8000A1953	1		•	•	Perno per albero di centraggio	Pin for centering shaft
9	800092865	1		•	•	Attr. bilanciamento ruota posteriore	Rear wheel balancing tool
10	800095850	1		•	•	Pinza montaggio/ smontaggio fascette clic R	Pliers for clic R clamps assembly/ disassembly
11	800098321	1		•	•	Pinza inclinata monta fascette clic R	Clic R clamp fitting pliers
12	800092866	1		•	•	Attrezzo montaggio pacco forcellone	Fork pack assembly tool
13	8000B6785	1		•		Attrezzo parapolvere e paraolio	Dust cover and oil splash guard tool
14	800092854	1		•	•	Chiave per mozzo eccentrico	Wrench adjustment eccentric hub
15	800092855	1		•	•	Prolunga per chiave mozzo eccentrico	Extension for wrench adjustment eccentric hub
16	8000B6871	1			•	Attrezzo sostituzione boccole	Bush replacement tool
17	8000B6872	1			•	Collare montaggio	Mounting collar
18	8000B6873	1			•	Collare smontaggio	Dismounting collar
19	8000B6874	1			•	Barra	Draw bar
20	8000B6875	1			•	Anello di guida	Guide ring
21	8000B6877	1			•	Chiave	Wrench
22	8000B6878	1			•	Attrezzo estrattore	Puller tool
23	8000B6920	1		•	•	Attrezzo montaggio cuscinetti tiranti sospensione posteriore	Rear suspension links bearing tool



Special tools

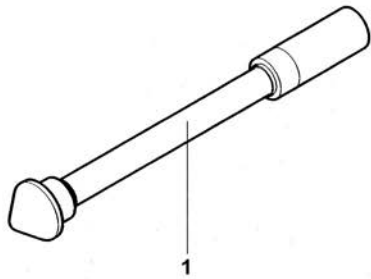

1

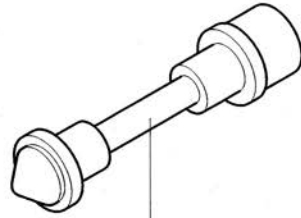

2

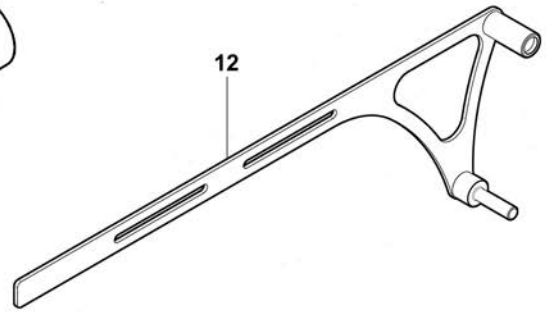

12

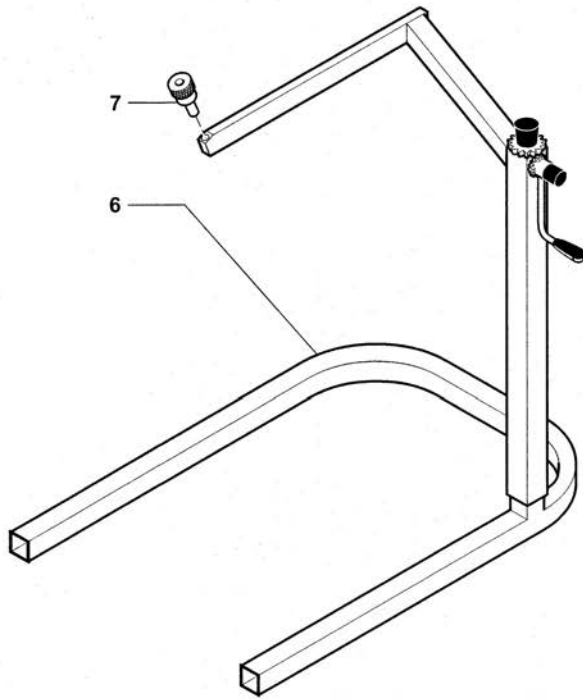

6

7

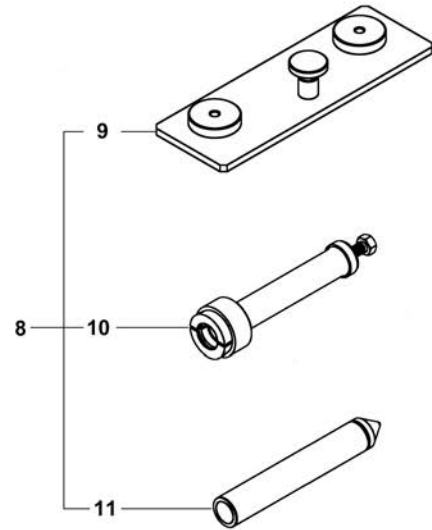

8

9

10

11

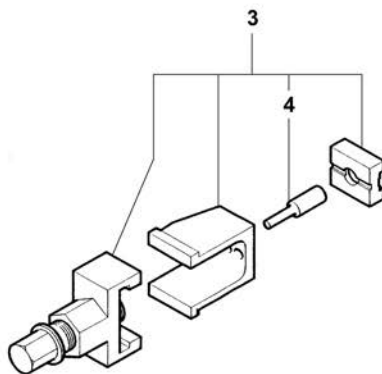

3

4

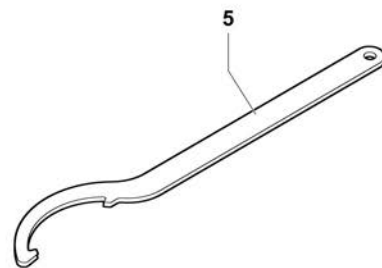

5

M



Special tools

N.	Code	Q.ty	Note	F3 675	F3 ORO	Descrizione	Description
1	8000B6782	1		•	•	Attrezzo montaggio pacco bilanciere	Equaliser pack tool
2	8000B4421	1		•	•	Attrezzo cuscinetti ruota anteriore	Front wheel bearings tool
3	800095389	1		•	•	Attrezzo catena	Chain tool
4	800095390	1		•	•	Perno taglio e ribaditura	Cutting and riveting pin
5	8000B7038	1			•	Attrezzo regolazione ammortizzatore posteriore	Rear damper adjusting tool
6	800095807	1		•	•	Cavalletto anteriore	Front stand
7	8000B7340	1		•	•	Perno cavalletto anteriore	Front stand pin
8	8000B6779	1		•	•	Attrezzo cuscinetto perno di sterzo	Steering pin bearing tool
9	8000B6780	1		•	•	Piastra di riscontro base di sterzo	Steering base plate
10	8000B6781	1		•	•	Estrattore cuscinetto perno di sterzo	Steering pin bearing extractor
11	800097890	1		•	•	Attrezzo montaggio cuscinetto perno di sterzo	Steering pin bearing assembly tool
12	8000B6787	1		•	•	Asta settaggio sospens. posteriore	Rear suspension setting rod



Special tools

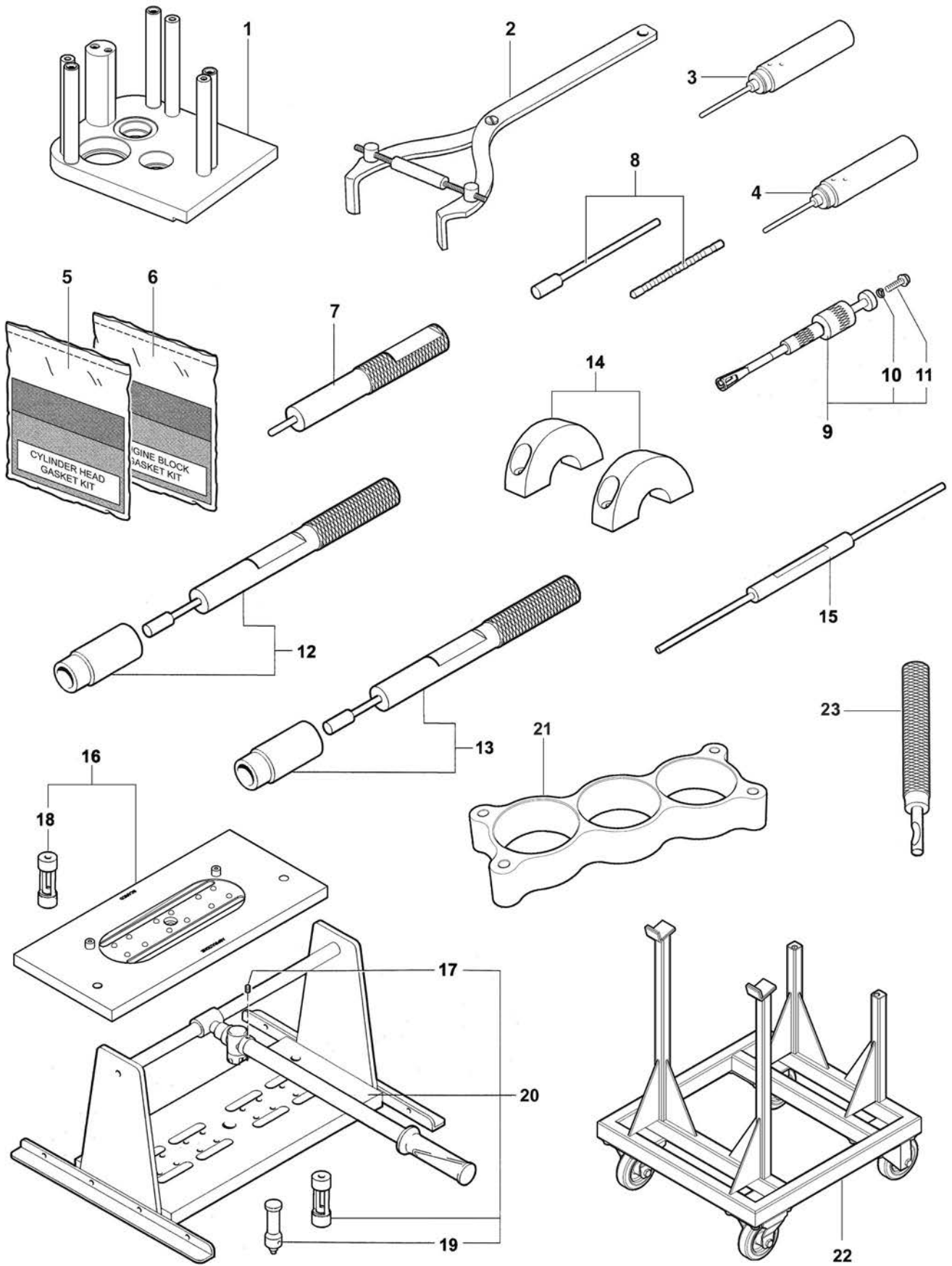

M



Special tools

N.	Code	Q.ty	Note	F3 675	F3 ORO	Descrizione	Description
1	8000B7177	1		•	•	Attrezzo montaggio cambio	Gear change mounting tool
2	800079015	1		•	•	Attrezzo bloccaggio frizione	Clutch blocking tool
3	8000B7293	1		•	•	Tampone per sede valvola scarico	Pad for exhaust valve seat
4	8000B7294	1		•	•	Tampone per sede valvola aspirazione	Pad for intake valve seat
5	8000B7295	1		•	•	Kit guarnizioni testa	Cylinder head gasket kit
6	8000B7296	1		•	•	Kit guarnizioni basamento	Engine block gasket kit
7	800095581	1		•	•	Punzone montaggio tenute valvola	Valve seals mounting punch
8	8000A2625	1		•	•	Broccia per guida valvole	Broach for valve guide
9	800094798	1		•	•	Attrezzo smontaggio gommini valvola	Valve rubber caps removal tool
10	62N115538	1		•	•	Rosetta elastica	Spring washer
11	8C0069056	3		•	•	Vite M8x30	Screw M8x30
12	8000A2385	1		•	•	Tampone montaggio guida scarico	Guide mounting pad, exhaust
13	8000B4368	1		•	•	Tampone montaggio guida aspirazione	Guide mounting pad, inlet
14	8000B7214	2		•	•	Attrezzo montaggio/ smontaggio albero motore	Crank shaft installation/ removal tool
15	800095429	1		•	•	Tampone controllo	Gauge pad
16	8000B7254	1		•	•	Piastra di base	Base plate
17	800051521	2		•	•	Vite M4x6	Screw M4x6
18	8000B7255	1		•	•	Attrezzo smontaggio semiconi	Half-cones removal tool
19	800095180	1		•	•	Attrezzo montaggio semiconi	Half-cones installation tool
20	800094796	1		•	•	Piastra montaggio/ smontaggio valvole	Valves installation/ removal plate
21	8000B7207	1		•	•	Piastra montaggio pistoni	Piston assembling tool
22	8000B6789	1		•	•	Supporto smontaggio/ montaggio motore	Engine removal/ installation support
23	8000B7299	1		•	•	Attrezzo montaggio perno ingranaggio rinvio avviamento	Mounting tool for starter motor idler gear pin



Special tools



Tightening torques

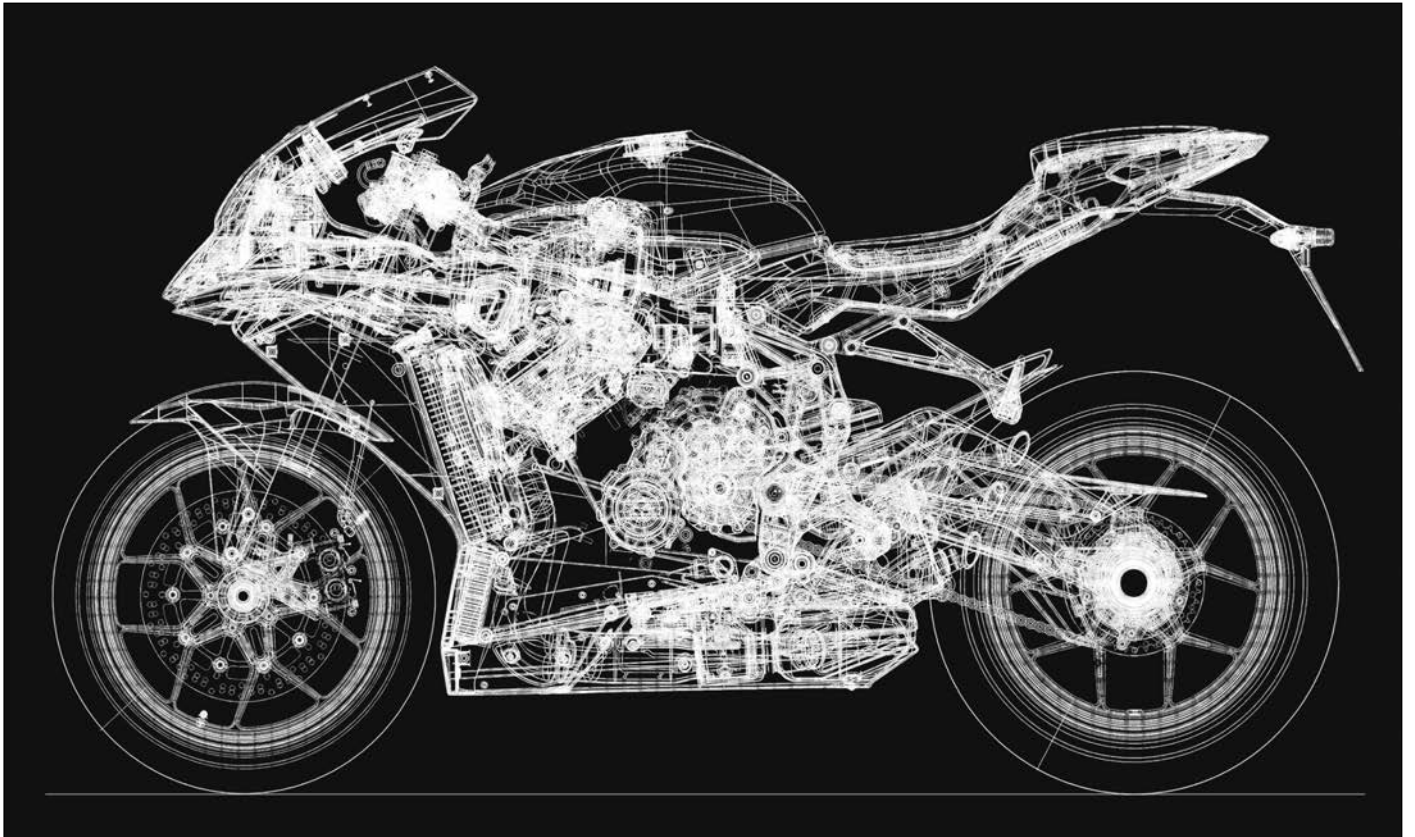

SECTION N

Revision 0

N



Tightening torques

Frame tightening torques for MV Agusta F3 675

For screws and nuts not shown in the table:

Dimensions and type	Description	Strength class	Tightening torque
M4 x 0.7	Generic screws and nuts	8.8	3 Nm
M5 x 0.8	Generic screws and nuts	8.8	5 + 7 Nm
M6 x 1	Generic screws and nuts	8.8	8 + 10 Nm
M8 x 1.25	Generic screws and nuts	8.8	22 ± 24 Nm

Key to colours and symbols:

- With grease on first threads only
- Without grease
- With sealant
- With sealant and grease
- With sealant and grease, Loctite 243
- With sealant and grease, Loctite 243
- With sealant and grease, Loctite 243 and 270
- With sealant and grease, Loctite 243 and 270, 0.8 ± 1 mm

Key to colours and symbols:

- No lubrication required
- Lubrication required
- With threadlocking fluid

Tightening sequence: 1, 2, 3, 4, 5, 6, 7, 8, 9, 10, 11, 12, 13

Passenger seat screws: 14 ± 16 Nm

220 ± 240 Nm
 With grease on first threads only
 Do not apply grease over the conical part of the nut.

55 ± 60 Nm
 With grease on first threads only

45 ± 50 Nm
 With grease on first threads only

24 ± 28 Nm
 With grease on first threads only

24 ± 28 Nm
 With grease on first threads only

55 ± 60 Nm
 With grease on first threads only

55 ± 60 Nm
 With grease on first threads only

4 + 5 Nm
 Loctite 243 on external screw head (irreversibility)

22 ± 24 Nm
 With grease on first threads only

16 ± 18 Nm
 With grease on first threads only

18 Nm
 With grease on first threads only

6 Nm
 Without grease

23 ± 26 Nm
 Without grease

16 ± 18 Nm
 With grease on first threads only

7 + 8 Nm
 With grease on first threads only

23 ± 25 Nm
 Loctite 243

42 ± 46 Nm
 With grease

16 ± 18 Nm
 Without grease

8 ± 10 Nm
 Without grease

24 ± 26 Nm
 With grease on first threads only

70 ± 75 Nm
 With grease on first threads only

23 ± 25 Nm
 Loctite 243

55 ± 60 Nm
 With grease on first threads only

8 + 10 Nm
 Without grease

55 ± 60 Nm
 With grease on first threads only

40 ± 44 Nm
 With grease on first threads only

40 ± 44 Nm
 With grease on first threads only

30 ± 35 Nm
 Loctite 243

18 ± 20 Nm
 Loctite 270

8 ± 10 Nm
 Loctite 243

8 + 10 Nm
 Without grease

16.5 ± 19.5 Nm
 With sealer (D3 grease) on first threads only

Into contact + 10°
 With grease on first threads only

10 Nm
 With grease on first threads only

4 + 5 Nm
 With grease on first threads only

4 + 5 Nm
 With grease on first threads only

Into contact + 90°
 Into contact + 90°

Into contact + 90°
 Into contact + 90°

Frame tightening torques for MV Agusta F3 675

Key to colours and symbols:

Tightening torque

Tightening sequence

Key characteristic

No lubrication required

Lubrication required

With threadlocking fluid

For screws and nuts not shown in the table:

Dimensions and type	Description	Strength class	Tightening torque
M4 x 0.7	Generic screws and nuts	8.8	3 Nm
M5 x 0.8	Generic screws and nuts	8.8	5 + 7 Nm
M6 x 1	Generic screws and nuts	8.8	8 + 10 Nm
M8 x 1.25	Generic screws and nuts	8.8	22 + 24 Nm

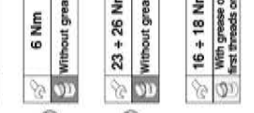
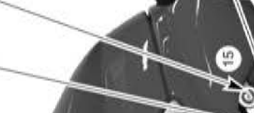
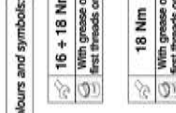
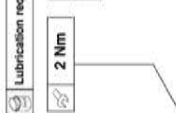
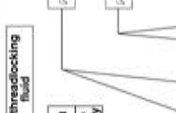

N. 3 chain upper pad screws: 6 + 8 Nm

Pin head diameter after riveting = Ø 5.5 mm

N. 3 chain lower: 24 + 26 Nm

Spacer screw: 8 + 10 Nm

Place the sensor in the horizontal or vertical position, depending on the tightening condition.

Bring screw into contact. Allow free movement of the side stand.

Tighten the nut to 25 Nm. Allow free movement of the side stand.

With grease on first threads only

Without grease

Without grease

Without grease

Without grease

Without grease

Without grease

Without grease

Without grease

Without grease

Without grease





Tightening torques

Frame tightening torques for MV Agusta F3 ORO

For screws and nuts not shown in the table:

Dimensions and type	Description	Strength class	Tightening torque
M4 x 0.7	Generic screws and nuts	8.8	3 Nm
M5 x 0.8	Generic screws and nuts	8.8	5 + 7 Nm
M6 x 1	Generic screws and nuts	8.8	8 + 10 Nm
M8 x 1.25	Generic screws and nuts	8.8	22 + 24 Nm



- With threadlocking fluid
- Lubrication required
- No lubrication required
- Key Characteristic
- Tightening sequence
- Tightening torque

8 Nm
Loctite 2400

8 Nm
Loctite 2700

25 Nm
Loctite 2400

4 Nm

8 Nm
Loctite 2700

8 Nm
Loctite 2400

8 Nm
Loctite 2700

2 Nm

16 + 18 Nm
With grease on first threads only

10 Nm

18 Nm
With grease on first threads only

23 + 26 Nm
Without grease

8 Nm
Without grease

19 Nm
With grease on first threads only

60 Nm
With grease on first threads only

5 Nm

55 + 60 Nm
With grease on first threads only

24 + 28 Nm

24 + 28 Nm

8 + 10 Nm
Loctite 243

3 + 4 Nm

25 Nm
Without grease

3 Nm
Loctite 243

200 + 220 Nm
With grease only on the screw threads

Pin head diameter after riveting = Ø 5.5 mm

28 + 32 Nm
With grease on first threads only

18 Nm
Loctite 243

20 + 22 Nm
Loctite 270

23 + 26 Nm
Without grease

8 + 10 Nm
Loctite 243

5 + 7 Nm
Loctite 243

1. Bring screw into contact
With grease on first threads

2. Tighten the nut to 25 Nm

Allow free movement of the side stand

6 + 8 Nm

10 Nm

18 Nm
Loctite 377

Place the sensor in the horizontal or vertical position in the tightening condition

10 Nm
Loctite 243

6 Nm

6 Nm

8 + 10 Nm
With grease on first threads only

16 + 18 Nm
Without grease

24 + 26 Nm
With grease on first threads only

40 + 44 Nm
Loctite 243

Sensor screw:
8 + 10 Nm
Loctite 243

N. 3 chain lower
and
6 + 8 Nm
With grease on first threads only

N. 3 chain upper
pod screws:
6 + 8 Nm
With grease on first threads only



Tightening torques

N



Diagnostic

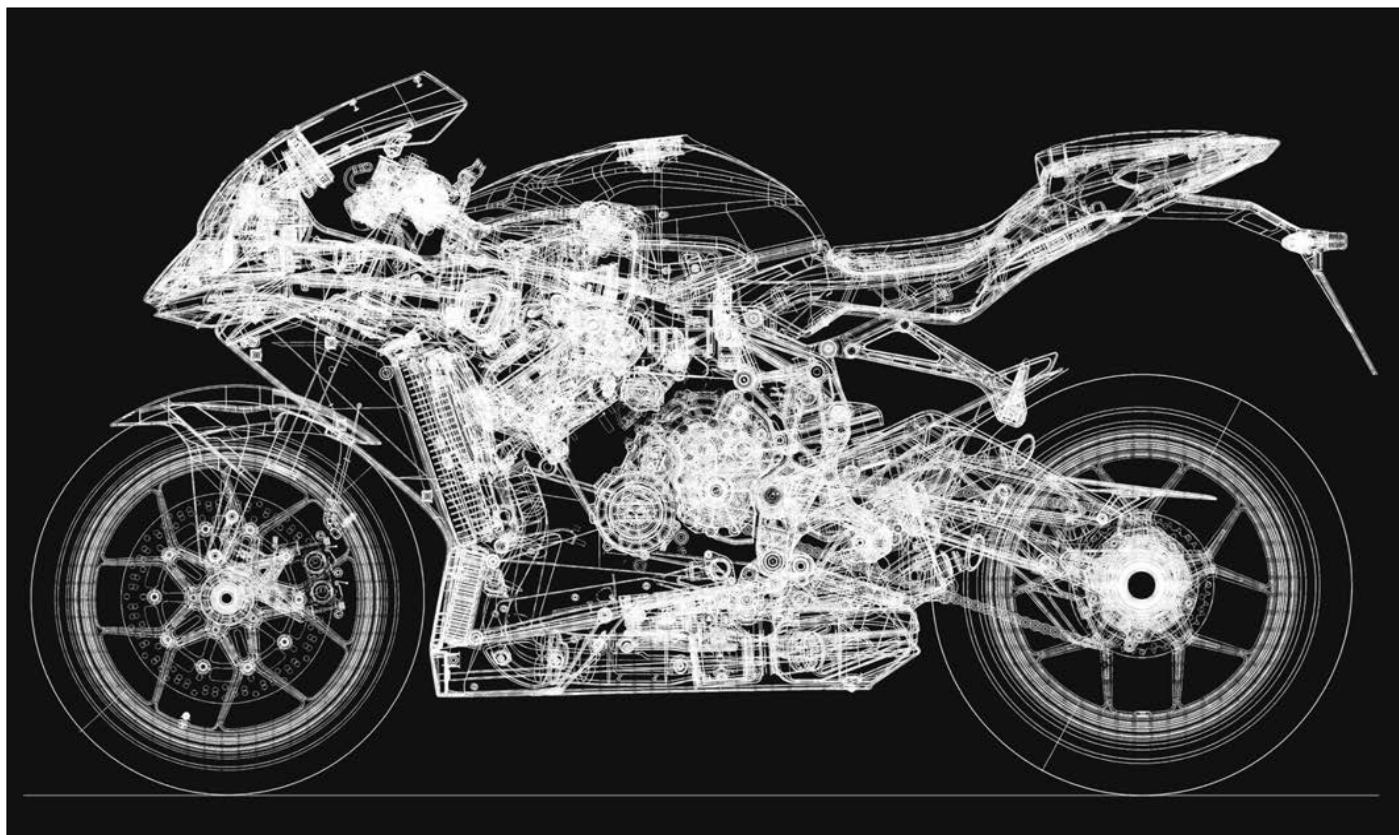

SECTION 0

Revision 0





Diagnostic

ELECTRICAL COMPONENTS

BATTERY CHARGING SYSTEM

Battery warning light on

Check the condition of the fuse on the remote switch	Replace
Faulty fuse connection on remote switch	Deoxidize/Repair
Faulty remote switch connection	Deoxidize/Repair
Battery connection defective	Deoxidize/Repair
Battery faulty	Replace
Alternator broken	Replace
Alternator connection defective	Deoxidize/Repair

POWER SUPPLY FOR 12V SERVICES

No function enabled

Check the condition of the fuse on the remote switch	Replace
Ignition switch broken	Replace
Ignition switch connection defective	Deoxidize/Repair
Main relay broken	Replace
Main relay connection defective	Deoxidize/Repair
Check condition of fuse 5	Replace
Fuse 5 connection faulty	Deoxidize/Repair

ELECTRIC STARTER

Electric starter does not work

Faulty engine earth connection	Deoxidize/Repair
Faulty power cable connection	Deoxidize/Repair
Faulty battery power cable connection	Deoxidize/Repair
Faulty or dead battery	Replace
'On off' button on right switch on 'off'	Turn on
Right-hand switch faulty	Replace
Right-hand switch unit connection faulty	Deoxidize/Repair
Starting relay broken	Replace
Starting relay connection faulty	Deoxidize/Repair
Starter motor broken	Replace
Faulty starter cable connection	Deoxidize/Repair
Clutch pump switch broken	Replace
Faulty clutch switch connection	Deoxidize/Repair
Fall detection sensor failure	Replace
Faulty fall detection sensor connection	Deoxidize/Repair
Side stand switch failure	Replace
Faulty side stand switch connection	Deoxidize/Repair
Check condition of fuse 5	Replace
Fuse 5 connection faulty	Deoxidize/Repair

COOLING SYSTEM

Electric fan do not work

Electric fan broken	Replace
Electric fan connection faulty	Deoxidize/Repair
Check condition of fuse 7	Replace
Fuse 7 connection faulty	Deoxidize/Repair
Failure of the water sensor in the radiator	Replace
Faulty connection for water sensor in the radiator	Deoxidize/Repair
Fan relay connection faulty	Deoxidize/Repair
Fan relay broken	Replace
ECU failure	Replace
Faulty ECU connection	Deoxidize/Repair

LIGHTS/INDICATORS

Position lights not working

Front light failure	Replace
Faulty front light connection	Deoxidize/Repair
Tail light failure	Replace
Faulty front light connection	Deoxidize/Repair
Check condition of fuse 3	Replace
Fuse 3 connection faulty	Deoxidize/Repair
Ignition switch broken	Replace
Ignition switch connection faulty	Deoxidize/Repair
Bulb burnt out	Replace
Bulb connection faulty	Deoxidize/Repair
Faulty front light connection	Deoxidize/Repair
Check condition of fuse 4	Replace
Fuse 4 connection faulty	Deoxidize/Repair
Lights switch broken	Replace
Lights switch connection faulty	Replace

High beam does not work



Diagnostic

Low beam does not work	Bulb burnt out	Replace
	Bulb connections faulty	Deoxidize/Repair
	Faulty front light connection	Deoxidize/Repair
	Check condition of fuse 4	Replace
	Fuse 4 connection faulty	Deoxidize/Repair
	Lights switch broken	Replace
	Lights switch connection faulty	Deoxidize/Repair
	Lights switch broken	Replace
	Lights switch connection faulty	Replace
	Stop light bulb burnt out	Replace
High beam flashing light not working (with steady high beam function working) The stop light does not work or always stays on	Bulb connections faulty	Deoxidize/Repair
	Rear brake lever switch broken	Deoxidize/Repair
	Rear brake lever switch connection faulty	Replace
	Front brake lever switch connection faulty	Deoxidize/Repair
	Lights switch broken	Replace
	Lights switch connection faulty	Deoxidize/Repair
	Rear brake lever switch broken	Replace
	Rear brake lever switch connection faulty	Deoxidize/Repair
	Check condition of fuse 6	Replace
	Fuse 6 connection faulty	Deoxidize/Repair
Indicators do not work	Check condition of fuse 6	Replace
	Fuse 6 connection faulty	Deoxidize/Repair
	Lights switch broken	Replace
	Lights switch connection faulty	Deoxidize/Repair
	Flasher unit broken	Replace
	Flasher unit connection faulty	Deoxidize/Repair
E. A. S. ELECTRONICALLY ASSISTED SHIFT (WHERE INCLUDED)		
	Check whether it is enabled from the dedicated dashboard page	Turn on
	Shift sensor failure	Replace
	Faulty shift sensor connection	Deoxidize/Repair
	Faulty ECU connection	Deoxidize/Repair
TRACTION CHECK		
	Check whether it is enabled from the dedicated dashboard page	Turn on
	Check for faults relative to the speed sensor, indicated on the dashboard	Replace
	ECU failure	Replace
	Faulty ECU connection	Deoxidize/Repair
SPEED LIMITER		
	Check whether it is enabled from the dedicated dashboard page	Turn on
	Check for faults relative to the speed sensor, indicated on the dashboard	Replace
	ECU failure	Replace
	Faulty ECU connection	Deoxidize/Repair
HORN		
Horn does not work		
	Horn broken	Replace
	Horn connection faulty	Deoxidize/Repair
	Check condition of fuse 6	Replace
	Fuse 6 connection faulty	Deoxidize/Repair
	Lights switch broken	Replace
	Lights switch connection faulty	Deoxidize/Repair
INSTRUMENT PANEL		
The dashboard does not turn on (while the other functions of the motorcycle are working)		
	Check condition of fuse 5	Replace
	Fuse 6 connection faulty	Deoxidize/Repair
	Instrument panel broken	Replace
	Instrument panel connection faulty	Deoxidize/Repair
Oil light with the engine off does not switch on	Oil pressure sensor broken	Replace
	Oil pressure sensor connection faulty	Deoxidize/Repair
	Instrument panel broken	Replace
	Instrument panel connection faulty	Deoxidize/Repair
Oil light with the engine running stays on	Check the engine oil level	Repair
	Oil pressure sensor broken	Replace
	Oil pressure sensor connection faulty	Deoxidize/Repair
	Instrument panel broken	Replace
	Instrument panel connection faulty	Deoxidize/Repair
Side stand warning light does not work	Side stand switch broken	Replace
	Side stand switch connection faulty	Deoxidize/Repair
	Instrument panel broken	Replace
	Instrument panel connection faulty	Deoxidize/Repair
	ECU failure	Replace
	Faulty ECU connection	Deoxidize/Repair



Diagnostic

Battery warning light does not work

Instrument panel broken Replace
Instrument panel connection faulty Deoxidize/Repair
ECU failure Replace

The idle light does not come on

Faulty ECU connection Deoxidize/Repair
Gear position sensor broken Replace
Gear position sensor connection faulty Deoxidize/Repair
Instrument panel broken Replace

Indicator warning light does not work (with the indicators working)

Instrument panel connection faulty Deoxidize/Repair
Problem with diodes in the electric cabling Replace the cabling
Instrument panel broken Replace

Low fuel warning light does not work

Instrument panel connection faulty Deoxidize/Repair
Fuel level sensor broken Replace
Fuel pump connection faulty Deoxidize/Repair
Instrument panel broken Deoxidize/Repair

High beam warning light does not work (with the high beams working)

Instrument panel connection faulty Deoxidize/Repair
Instrument panel broken Replace

Rev limiter light does not come on

Instrument panel connection faulty Deoxidize/Repair
Instrument panel broken Replace
Instrument panel connection faulty Deoxidize/Repair
ECU failure Replace

CAN line error

Faulty ECU connection Deoxidize/Repair
Instrument panel broken Replace
Instrument panel connection faulty Deoxidize/Repair
ECU failure Replace
Faulty ECU connection Deoxidize/Repair

Error messages

Page management not possible

See diagnostic messages
Handlebar controls left side broken Replace
Faulty accident control connection Deoxidize/Repair
Instrument panel broken Replace
Instrument panel connection faulty Deoxidize/Repair

INJECTION

Any errors reported to the dashboard

No injection due to lack of fuel pump

See diagnostic
Check condition of fuse 1 Replace
Fuse 1 connection faulty Deoxidize/Repair
Injection relay broken Replace
Injection relay connection faulty Deoxidize/Repair
Fuel pump broken Replace
Fuel pump connection faulty
ECU failure Replace

Injector does not inject fuel

Faulty ECU connection Deoxidize/Repair
Check condition of fuse 2 Replace
Fuse 1 connection faulty Deoxidize/Repair
Injection relay broken Replace
Injection relay connection faulty Deoxidize/Repair
ECU failure Replace

No injection due to lack of high injector operation

Faulty ECU connection Deoxidize/Repair
Faulty high injector cabling connection Deoxidize/Repair
Check condition of fuse 2 Replace
Fuse 2 connection faulty Deoxidize/Repair
Injection relay broken Replace
Injection relay connection faulty Deoxidize/Repair
ECU failure Replace
Faulty ECU connection Deoxidize/Repair

IGNITION SYSTEM

Any errors reported to the dashboard

No sparks at the plugs

See diagnostic
Engine earth connection faulty Deoxidize/Repair
Check condition of fuse 1 Replace
Fuse 2 connection faulty Deoxidize/Repair
Faulty single reel connection Deoxidize/Repair
Injection relay broken Replace
Injection relay connection faulty Deoxidize/Repair
ECU failure Replace
Faulty ECU connection Deoxidize/Repair



Diagnostic

DIAGNOSTICS

DASHBOARD INSTRUCTIONS

PRESSURE SENSOR

Faulty pressure sensor connection	Deoxidize/Repair
Rubber fitting pipe damaged or not connected	Repair/Replace
Pressure sensor damaged	Replace
Faulty ECU connection	Deoxidize/Repair
ECU failure	Replace
Problem with the electrical system	Repair/Replace

PHASE ERROR

AIR TEMP

See above	
Faulty air temperature sensor connection	Deoxidize/Repair
Air temperature sensor failure	Replace
Faulty ECU connection	Deoxidize/Repair
ECU failure	Replace
Problem with the electrical system	Repair/Replace

H2O SENSOR

Using a diagnostic instrument check which if the two sensors is faulty	
Faulty engine water temperature sensor connection	Deoxidize/Repair
Engine coolant temperature sensor broken	Replace
Faulty engine coolant temperature sensor connection	Deoxidize/Repair
Radiator coolant temperature sensor broken	Replace
Faulty ECU connection	Deoxidize/Repair
ECU failure	Replace
Problem with the electrical system	Repair/Replace

THROTTLE POSITION

Faulty throttle body connection	Deoxidize/Repair
Throttle body position sensor failure	Change throttle body
Faulty ECU connection	Deoxidize/Repair
ECU failure	Replace

LAMBDA SENSOR

Problem with the electrical system	Repair/Replace
Faulty lambda probe connection	Deoxidize/Repair
Lambda probe failure	Replace
Faulty ECU connection	Deoxidize/Repair
ECU failure	Replace
Problem with the electrical system	Repair/Replace

EXHAUST VALVE

Faulty exhaust valve actuator connection	Deoxidize/Repair
Exhaust valve actuator failure	Replace
Incorrect adjustment/installation of valve cables	Repair
Broken exhaust valve cables	Replace
ECU failure	Replace
Faulty ECU connection	Deoxidize/Repair
Problem with the electrical system	Repair/Replace

INJECTOR N LOW (N=1, 2, 3)

Injector N connection faulty	Deoxidize/Repair
Injector N broken	Replace
ECU failure	Replace
Faulty ECU connection	Deoxidize/Repair
Problem with the electrical system	Repair/Replace

INJECTOR N UP (N=1, 2, 3)

Injector N connection faulty	Deoxidize/Repair
Injector N broken	Replace
ECU failure	Replace
Faulty ECU connection	Replace
Problem with the electrical system	Repair/Replace

GAS POSITION

Faulty gas control connection	Deoxidize/Repair
Gas control failure	Replace
ECU failure	Replace
Faulty ECU connection	Deoxidize/Repair
Problem with the electrical system	Repair/Replace

FUEL PUMP RELAY

Injection relay broken	Replace
Injection relay connection faulty	Deoxidize/Repair
ECU failure	Replace
Faulty ECU connection	Deoxidize/Repair
Fuel pump connection faulty	Deoxidize/Repair
Problem with the electrical system	Repair/Replace

RPM SENSOR

Faulty engine rev sensor connection	Deoxidize/Repair
engine rev sensor failure	Replace
ECU failure	Replace
Faulty ECU connection	Deoxidize/Repair
Problem with the electrical system	Repair/Replace



Diagnostic

COIL N	Faulty specified reel connection	Deoxidize/Repair
	Specified coil broken	Replace
	ECU failure	Replace
FAN RELAY	Faulty ECU connection	Deoxidize/Repair
	Problem with the electrical system	Repair/Replace
	Faulty fan relay connection	Deoxidize/Repair
	Fan relay failure	Replace
	ECU failure	Replace
SPEED SENSOR	Faulty ECU connection	Deoxidize/Repair
	Problem with the electrical system	Repair/Replace
	Faulty speed sensor connection	Deoxidize/Repair
	Speed sensor failure	Replace
	Broken or damaged phonic wheel	Repair/Replace
BATTERY VOLTAGE	Gap between sensor and phonic wheel not as specified	Repair
	Faulty voltage adjuster connection	Deoxidize/Repair
	Voltage adjuster failure	Replace
	Problem with the electrical system	Repair/Replace
	Faulty ECU connection	Deoxidize/Repair
ECU	Update the software with the latest available version	Repair
	ECU failure	Replace
STARTER RELAY	Faulty relay starter connection	Deoxidize/Repair
	Relay starter failure	Replace
	Problem with the electrical system	Repair/Replace
	Faulty ECU connection	Deoxidize/Repair
	ECU failure	Replace
DBW	Faulty throttle body connection	Deoxidize/Repair
	Throttle body sensors failures	Change throttle body
	Throttle body locked	Repair/Replace
	Problem with the electrical system	Repair/Replace
	Faulty ECU connection	Deoxidize/Repair
	ECU failure	Replace
SENSOR SUPPLY	Problem with the electrical system	Repair/Replace
	Faulty ECU connection	Deoxidize/Repair
	ECU failure	Replace
CLUTCH SWITCH	Faulty connection to the clutch switch	Deoxidize/Repair
	Clutch switch out of place	Deoxidize/Repair
	Faulty clutch switch	Replace
	Problem with the electrical system	Repair/Replace
SAFETY	Update the software with the latest available version	Replace
	ECU failure	Replace
LOW BEAM RELAY	Faulty light relay connection	Deoxidize/Repair
	Light relay failure	Replace
	Problem with the electrical system	Repair/Replace
	Faulty ECU connection	Deoxidize/Repair
	ECU failure	Replace
TIP OVER	Faulty tilt sensor connection	Deoxidize/Repair
	Tilt sensor failure	Replace
	Problem with the electrical system	Repair/Replace
	Faulty ECU connection	Deoxidize/Repair
GEAR SENSOR	ECU failure	Replace
	Faulty gear sensor connection	Deoxidize/Repair
	Gear sensor failure	Replace
	Problem with the electrical system	Repair/Replace
	Faulty ECU connection	Deoxidize/Repair
	ECU failure	Replace



Diagnostic

FRAME

STEERING

Steering stiff

Steering bearings damaged	Replace
Steering bearings overtightened	Adjust
Steering pin bent	Replace
Steering damper action excessive	Adjust
Steering damper joints damaged	Replace
Tyre pressure low	Adjust

Vehicle tends to steer or does not travel on a straight line

Fork bent	Replace
Frame bent	Replace
Swingarm bent	Replace
Steering damper joints damaged	Replace
Steering bearings damaged	Replace
Wheel spindle bent	Replace
Swingarm bearings damaged	Replace

FRONT WHEEL

Front wheel wobbles/vibrates

Wheel rim bent	Replace
Wheel unbalanced	Balance
Tyre faulty	Replace
Tyre unsuitable	Replace
Wheel bearings damaged	Tighten
Spindle fixing screws loose	Tighten
Spindle ring nut loose	Tighten

Front wheel hardly turns

Wheel bearings damaged	Replace
Wheel spindle bent	Replace
Brake pad friction on discs excessive (see brakes)	Check
Brake discs bent	Replace
Wheel spindle ring nut overtightened	Use prescribed torque

FRONT SUSPENSION

Front suspension soft

Fork oil deteriorated	Renew
Spring preload low	Adjust
Hydraulic compression damping insufficient	Adjust
Fork oil level low	Top up
Tyre pressure low	Adjust
Fork damaged	Repair

Front suspension stiff

Spring preload excessive	Adjust
Hydraulic compression damping excessive	Adjust
Swingarm oil level high	Adjust
Tyre pressure high	Adjust

REAR WHEEL

Rear wheel wobbles/vibrates

Wheel rim bent	Replace
Wheel unbalanced	Balance
Tyre faulty	Replace
Tyre unsuitable	Replace
Wheel bearings damaged	Replace
Locknut loose	Tighten
Suspension screws loose	Tighten

Rear wheel hardly turns

Suspension bearings damaged	Replace
Wheel bearings damaged	Replace
Wheel hub circlip displaced	Check
Brake pad friction on discs excessive	Check
Brake disc bent	Replace
Drive chain damaged	Replace

REAR SUSPENSION

Rear suspension soft

Spring preload excessive	Adjust
Hydraulic compression damping (high/low speed) insufficient	Adjust
Hydraulic rebound damping insufficient	Adjust
Tyre pressure low	Adjust
Shock absorber damaged	Replace



Diagnostic

Rear suspension stiff

Spring preload excessive	Adjust
Hydraulic compression damping (high/low speed) excessive	Adjust
Hydraulic rebound damping excessive	Adjust
Tyre pressure high	Adjust
Swingarm bearings damaged	Replace
Swingarm rocker bearings damaged	Replace
Shock absorber joints damaged	Replace
Suspension linkage joints damaged	Repair
Swingarm pin bent	Replace

BRAKES

Brake lever and pedal soft ("spongy")

Air bubbles in hydraulic circuit	Bleed
Leaks in hydraulic circuit	Repair
Caliper seals damaged	Replace
Pump seals damaged	Replace
Caliper pistons do not slide freely	Check
Brake fluid level low	Top up
Brake discs distorted	Replace

Brake lever or pedal stiff

Brake lever or pedal bent	Replace
---------------------------	---------

Braking action insufficient

Disks dirty	Clean
Air bubbles in hydraulic circuit	Bleed
Leaks in hydraulic circuit	Repair
Caliper seals damaged	Replace
Pump seals damaged	Replace
Caliper pistons do not slide freely	Check
Brake fluid level low	Top up
Brake discs distorted	Replace
Brake pad springs damaged	Replace
Brake discs distorted	Replace
Caliper pistons do not slide freely	Check
Brake fluid level too high	Adjust
Brake pads worn down	Replace

Brake pads rub against brake disks

EXHAUST SYSTEM

Exhaust noise excessive

Exhaust pipe damaged	Replace
Exhaust pipe fasteners loose	Tighten

Engine performance poor

Exhaust pipe damaged	Replace
Exhaust pipe fasteners loose	Tighten

COOLING SYSTEM

Engine temperature high

Coolant level low	Top up
Cooling fan faulty	Replace
Expansion tank cap faulty	Replace
Instrument temperature sensor faulty	Replace
Thermostat locked in closed position	Replace
Radiator fins bent or obstructed	Repair/Clean
Radiator scaly	Clean
Water pump damaged	Replace
Injection/ignition system faulty	Check
Fuel unsuitable	Change
Engine cooling circuit faulty	Check
Spark plug heat grade unsuitable	Replace
Carbon formation in cylinder head/piston	Clean
Thermostat locked in open position	Replace

Engine temperature low

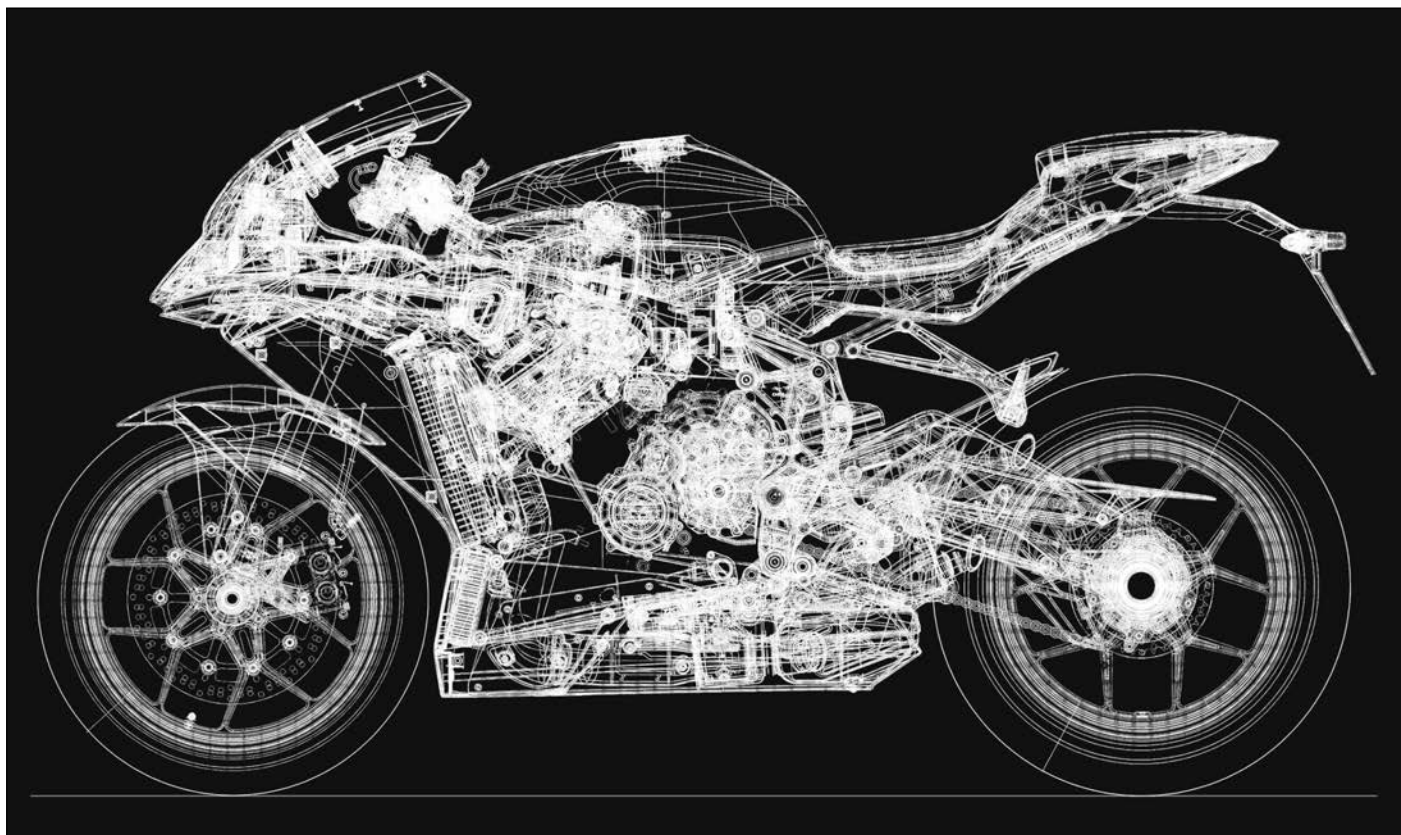

SECTION P
Revision 0

P



Analytical index

ANALYTICAL INDEX - F3 675 WORKSHOP MANUAL

Section A - General Description

Glossary and symbols	A-4
How to consult the manual	A-3
Index	A-8
Operative technical specification	A-9
Purpose of the manual	A-3
Right hand and left hand standards	A-5
Safety	A-6
Warning	A-8

Section B - Maintenance

Rear shock absorber	B-54
Battery	B-57
Brake / Gearchange commands check	B-41
Brake pads	B-45
Brakes	B-36
Checking engine during idle	B-34
Electrical system	B-57
Electric cooling fans	B-14
Engine coolant	B-11
Engine oil and oil filter	B-8
Front forks	B-56
Front headlight	B-98
Front wheel bearings	B-52
Fuel filters	B-20
Fuel pump assembly	B-27
Fuses	B-95
Lights	B-86
Locks	B-46
Maintenance and tuning operations	B-8
Nuts and bolts	B-57
Periodical maintenance schedule	B-6
Rear wheel hub	B-53
Side stand	B-55
Spark plugs	B-18
Steering	B-49
Swingarm bearings	B-53
Technical information	B-3
Transmission chain	B-49
Tube fastening bands	B-57
Tubes / Fuel fittings	B-29
Tyres	B-52
Valve mechanism adjustment	B-15
Wheels	B-53

Warning lights and instrumentation	B-57
------------------------------------	------

Section C - Bodywork

Air intake system	C-18
Fairing assembly	C-3
Fuel tank and intake air duct	C-12
Mudguard - central conveyor - radiator protection	C-23
Tail unit and heat shield	C-8

Section D - Air intake injection system

Actuators	D-13
Air intake system technical characteristics	D-15
Diagnostic system	D-14
ECU (Electronic control unit)	D-8
Engine control unit pinout	D-18
Fuel feed system	D-5
Fuel injector	D-6
Fuel pressure adjuster	D-6
Fuel pump check	D-11
Fuel pump control system	D-7
Injection arrest control	D-4
Injection system electrical diagram	D-17
Injection system technical characteristics	D-3
Injection time compensation (Volume)	D-4
Injector check	D-11
Positions of engine-control system parts	D-16
Sensors	D-8
– Throttle body position	D-10
– Atmospheric air temperature sensor	D-8

Section E - Electrical system

Battery	E-7
– Battery assembly	E-8
– Charge battery	E-7
– Efficiency check	E-12
– Recharging system	E-10
Connectors	E-3
Couplings	E-3
E. A. S.	E-25
ECU removal	E-36
Electrical diagram	E-5
– Parts list	E-6
Electric fan cooling system	E-35



Analytical index

Engine pick-up	E-25	Exhaust silencer disassembly	G-9
Fuses	E-3,22	Exhaust tubes removal	G-10
Gear switch	E-21	Exhaust valve transmissions assembly and adjustment	G-42
High beam headlight	E-32	Foot peg removal	G-8
Horn	E-36	Frame assembly on the vehicle	G-31
Instrumentation	E-27	Frame checks and inspection	G-27
– Enabling starter relay	E-30	– Steering bearings housing check	G-30
– Fuel level warning light switch check	E-28	Frame disassembly	G-25
– Ignition switch	E-30	Frame plate removal	G-36
– Oil pressure sensor	E-28	Frame removal preliminary operations	G-12
– R. P. M indicator	E-30	– Plug top coil disassembly	G-16
– Speed sensor	E-31	– Removing clutch control transmission	G-24
– Turn indicators check	E-30	– Removing the battery box	G-18
– Water sensor	E-29	– Removing the front cowl mounting frame	G-25
Licence plate light	E-34	– Removing the fuse panel mounting plate	G-23
Low beam headlight	E-31	– Removing the main cabling	G-20
Main relay	E-24	– Removing the passenger seat lock	G-23
Positioning of electrical system wire clamps	E-38	– Removing the solenoid starter	G-19
Rear tail lights and brake lights	E-33	– Throttle body removal	G-13
Run-Off safety switch	E-26	Rear frame disassembly	G-35
Semiconductor parts	E-4	Rear frame unit assembly	G-41
Side stand switch	E-21	Re-assembly of the vehicle	G-41
Spark plugs	E-23	Side stand removal	G-6
Starter system	E-13		
– Generator check	E-17		
– Starter motor assembly	E-19		
– Starter motor check	E-19		
– Starter motor removal	E-18		
– Starter relay check	E-19		
Switches	E-37		
Tilt sensor	E-20		
Timing wheel gap	E-26		
Turn indicators	E-33		

Section F - Suspension and wheels

Front forks F3 675	F-10
Front forks F3 ORO	F-11
Front wheel	F-3
Motorcycle set-up adjustment	F-79
Rear suspension and swingarm	F-45
Rear wheel hub	F-62
Steering assembly	F-34
Wheels - Check and balancing	F-81

Section G - Frame

Battery cables	G-3
----------------------	-----

Section H - Brakes

Front brake system	H-3
– Brake lever removal	H-18
– Front brake calipers substitution	H-13
– Front brake discs	H-19
– Front brake disc removal	H-20
– Front brake pads substitution F3 675	H-4
– Front brake pads substitution F3 ORO	H-6
– Front brake pump removal	H-14
– Replacing the brake fluid basin and connecting pipe to the pump	H-16
– Replacing the front brake switch	H-17
– Substitution and bleeding of the front brake fluid	H-8
Rear brake system	H-22
– Rear brake calipers substitution	H-27
– Rear brake disc	H-30
– Rear brake disc removal	H-30
– Rear brake pads substitution	H-23
– Substitution and bleeding of the rear brake fluid	H-25



Section L - Cooling system

Complete cooling system assembly	L-3
Cooling system leakage check	L-4
Disassembly of the recovery basin	L-10
Engine coolant extraction	L-5
Filling the cooling system	L-27
Motor oil system filling	L-28
Oil radiator assembly	L-25
Oil radiator component disassembly	L-23
Oil radiator disassembly	L-22
Water radiator cap check	L-4
Water radiator component assembly	L-16
Water radiator component disassembly	L-11
Water radiator disassembly	L-6
Water radiator vehicle unit assembly	L-21
System function verification	L-29
Thermostatic valve assembly	L-20
Thermostatic valve removal	L-18

Section M - Special tools

Maintenance tools	M-2
-------------------	-----

Section N - Torque pressure

Frame tightening torques F3 675	N-2
Frame tightening torques F3 ORO	N-4

Section O - Diagnostic

Electrical components	O-2
Frame	O-7

Section P - Analytical index

Analytical index - F3 675 workshop manual	P-2
---	-----



MV Agusta Motor S.p.A. - Technical Assistance Service
Via Giovanni Macchi, 144 - 21100 Varese (VA) ITALY
Tel. (Italy) 800.36.44.06 - (abroad) ++39 0332 254.712
Fax ++39 0332 329.379 - website "www.mvagusta.it"
Part No. 8A00B7594 Edition No. 1